

هنا صدق القول



FINANCIAL TIMES

Creusot-Loire: the struggle for survival, Page 18

EUROPE'S BUSINESS NEWSPAPER

No. 29,307

Friday April 27 1984

D 8523 B

Asia	Sch. 18	Indonesia	Rp 2500	Portugal	Esc 20
Bahamas	Da 0.850	Italy	L. 1100	S. Arabia	Ric 8.00
Bahrain	Dh 0.39	Japan	¥ 155	Singapore	S\$ 4.10
Canada	Cdn 1.00	Saudi	R. 100	Spain	Ptas 100
Ceylon	LKR 100	Taiwan	N.T. 80	Switzerland	Sfr 2.20
Danmark	Dkr 7.25	Thailand	B. 5.00	S. Lanka	Rup 30
Denmark	Dkr 7.25	USSR	R. 25	Sweden	Skr 6.00
Egypt	E£ 1.00	West Germany	M 3.00	Switzerland	Sfr 2.20
France	Fr. 6.00	Yemen	Y. 20	Taiwan	N.T. 80
Germany	DM 2.30	Yugoslavia	D. 200	USA	\$ 1.00
Greece	Dr 50	Zambia	Z. 1.00		
Hong Kong	HK\$ 12				
India	Rs 15				

NEWS SUMMARY

GENERAL

Narrow loss for reform in Brazil
The Brazilian Opposition's proposal to restore direct presidential elections was narrowly defeated, by 22 votes, in Congress yesterday. The Bill failed after a long, angry debate, and despite the defection of 55 Government party deputies. Chants of "the struggle will continue" came from the packed public galleries, as organisers of the national campaign to end military rule vowed to fight on.

The Government is now waiting to see how the big cities react. If serious disturbances erupt, the emergency powers for the Brasilia area could be extended to other cities. Page 6

Tanker fire

The Saifna el-Arab, a Saudi-registered oil tanker, was ablaze near Kharg Island. Crew said it seemed to have been hit by a missile, but Iraq has not said it attacked ships in the area. Page 20

Border claim denied

West German border police, contradicting Pentagon reports that a U.S. army helicopter was fired on after crossing the Czech border last week, said it was just chased away by fighters.

Crash kills 17

At least 17 died and 30 were hurt when a train and bus collided near Oporto, Portugal.

Salute for Reagan

President Reagan became the first foreign leader to be welcomed to Peking by a 21-gun salute since the Cultural Revolution. He is visiting China for six days. Page 20

Hostages freed

Rightist Unita guerrillas freed 90 hostages held for up to six months in south Angola. Sixteen Britons are still captive. Page 4

Punjab deaths

Three people died in clashes in the Punjab, bringing the death toll since New Delhi took over direct rule of the state six months ago to 181. Page 4

Karami returns

Lebanese President Amin Gemayel appointed as Premier Rashid Karami, a Sunni Moslem backed by Syria, who has held the post nine times since 1955. Page 4

Iranians protest

Iranians sprayed teargas in the Frankfurt offices of Iran Air, in a protest against the Khomeini regime's detention of political prisoners. Other protests were held in London, Paris, Vienna and The Hague.

Olympic flare-up

The Greek Olympic Committee withdrew its co-operation in lighting the Olympic flame and running it across Greece. The Los Angeles games organisers' plans for it had provoked allegations of commercialisation.

Families released

Thirty dependents of British Embassy staff in Libya left Tripoli after several hours' unexplained delay. Libyan diplomats and families left London, after Britain's decision to end relations with Libya. Page 10

Briefly...

Count Basie, bandleader, died in Florida at 79.
Fire destroyed 900 hectares of forest in the Dordogne, France.

BUSINESS

ICI up to £245m in first quarter
IMPERIAL CHEMICAL Industries of Britain reported pre-tax profits for the first quarter of £245m (£343.7m), up £117m on the same period last year and £71m on the preceding quarter. The main improvement was in Western Europe. Page 20 and Lex; Details, Page 28

MOBIL, second biggest U.S. oil group, said first-quarter net income rose 52 per cent to \$380m, 93 cents a share, on sales of \$15bn (\$14.3bn). Page 21

FEDERAL Trade Commission tentatively approved a consent agreement to allow Standard Oil of California to acquire Gulf.

DOLLAR improved further in London, closing at DM 2.6865 (DM 2.6785), a two-month high. SwFr 2.227 (SwFr 2.217), Ffr 2.735 (Ffr 2.727) and Y226 (Y225.65). Its trade weighting was 129.0 (128.6). Page 43

STERLING lost 85 points in London at \$1.493 and was unchanged at DM 3.785 but lower at SwFr 3.1275 (SwFr 3.1252), Ffr 11.805 (Ffr 11.81) and Y311.25 (Y318.75). Its trade-weighted index was 0.1 lower at 79.8. Page 43

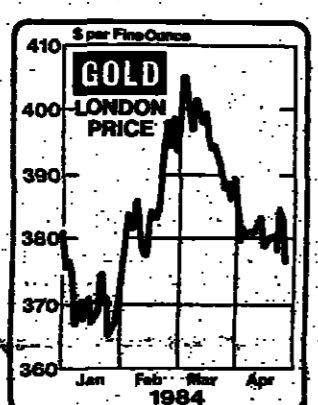

GOLD lost \$6 in London at \$376.75, \$4.5 in Frankfurt at \$377.75 and \$3.25 in Zurich at \$371.25. Page 42

LONDON: FT Industrial Ordinary index rose 11.5 to 899.1. Report, Page 37; FT share information service, Pages 38-39

WALL STREET: Dow Jones index was up 10.67 at 1,174.20 at 3.30pm. Report, Page 33; Full share listings, Pages 34-36

TOKYO: Nikkei Dow index added 35.18 at 10,901.52. The Stock Exchange index was 4.29 higher at 854.49. Report, Page 33; Leading prices, other exchanges, Page 36

ASIAN Development Bank was accused by developing country members of charging too much interest and not encouraging the use of local materials in projects. Page 4

McDONNELL DOUGLAS, U.S. aerospace group, posted a 13 per cent rise in first-quarter net earnings to \$67.5m, \$1.69 a share. Page 21

CERMOQ, Mexican brewery which owes \$370m abroad, faces a new bankruptcy threat as Northwestern National Bank of Minneapolis brings new legal proceedings. Page 21

MOET-HENNESSY, diversified French champagne company, announced a big advance in first-quarter sales. Net group profit rose 18.5 per cent to Ffr 401.8m (\$49m) in 1983. Page 24

SAAB-Scania, Swedish car and aerospace group, lifted sales by 24 per cent to Skr 1.76bn (\$77m) in the first quarter; earnings rose last year. Page 22

The editorial content of today's international edition has been restricted because of industrial action by IG Druck and Papier at Frankfurt. Societies-Druckerei, where the edition is printed. This prevents the publication of late-breaking news, the final Wall Street report and closing U.S. share prices.

SKr 3bn deal cuts ties between Volvo and Wallenberg

BY KEVIN DONE, NORDIC CORRESPONDENT, IN STOCKHOLM
The unprecedented power struggle between two of Sweden's leading industrial groups, Volvo and the Wallenberg conglomerate of financial and industrial corporations, reached its climax yesterday with each agreeing to sell its interest in the other's companies.

Volvo is to sell its 25 per cent holdings in Atlas-Copco, a leading engineering company, and Stora Kopparberg, one of the country's biggest forest product groups. It will make a capital gain on the deals of around SKr 1.3bn (\$164m).

The shares will be sold at a premium to investor and Providentia, the two investment companies which act as the linch pins of the Wallenberg industrial and financial federation.

Together they hold substantial stakes in some of Sweden's other major corporations, including Asens, Ericsson, Saab-Scania, SKF, Electrolux and SE Benken, the country's biggest bank.

At the same time investor and Providentia - both chaired by Mr Peter Wallenberg - have agreed to sell their holding of 12m A shares in Volvo to a series of investors to be approved by Volvo.

The A shares hold around 9 per cent of the votes in Volvo, the Nor-

dic region's biggest industrial corporation. In future investors and Providentia will hold only 600,000 B shares in Volvo. Each B share has only a tenth of a vote.

The various share deals have a market worth of around SKr 5bn, and together represent the biggest transaction in the history of the Swedish stock market.

Volvo traditionally had no large single shareholder until Wallenberg interests began buying heavily into the group in the last two years, building up a stake controlling 15 to 20 per cent of the votes.

The Wallenberg purchases were made as a defensive move to counter the holdings Volvo had already taken in Atlas Copco and Stora Kopparberg. Mr Peter Wallenberg is chairman of Atlas Copco and vice-chairman of Stora Kopparberg.

Mr Pehr Gyllenhammar, chairman of Volvo, is now expected to give up his seat on the Stora Kopparberg board but to remain on the Atlas Copco board.

The decision by both sides to disengage is a major blow to the legacy of Marcus Wallenberg, the man who for decades headed the most powerful industrial and financial dynasty in Sweden.

One of his last moves before his death in 1982 was to reach agreement with Mr Gyllenhammar for Volvo's entry into the Wallenberg group through the purchase of the holdings in Atlas and Stora.

The two sides admitted yesterday that "the co-operation had been neither effective nor practical". They had decided to disengage to avoid "potential conflicts of interest".

Mr Gyllenhammar admitted that there had been difficulties. "We went into something that we thought would be ideal for Swedish industry, but we have been forced to see that this was not the case," Mr Wallenberg admitted.

Tariff row could delay British Telecom issue

BY GUY DE JONGHERES IN LONDON
SHARP DISAGREEMENTS have arisen between British Telecom and the UK Government over the future regulation of BT's tariffs.

Unless the dispute is resolved quickly, it could delay the sale - planned for October - of 51 per cent of shares in the organisation, which is expected to raise £4bn (\$5.64bn).

The problem comes on top of growing government doubts about how much of the planned issue will be bought by UK institutions and foreign investors. It is now counting on raising no more than £2bn through the City of London and is therefore pinning its hopes on selling almost half the issue to as many as 2m individual telephone subscribers.

Although it still aims for an October sale, the UK Government is reconciled to the possibility of waiting until early December. Such a delay could, however, complicate the selling arrangements, not least because of market uncertainties about the outcome of the U.S. presidential election in early November.

BT is worried that government insistence on pegging its UK tariff increases to 3 percentage points below the rise in the retail price index could place it in a cash squeeze soon after privatisation. It wants the limit on increases to be only about one per cent less than the RPI.

Its concern is also echoed in the City of London. Major institutions are warning that tighter tariff controls would diminish BT's appeal as an investment and could threaten the success of the flotation, which is the biggest test yet of the UK Government's privatisation programme.

But despite an appeal from BT to reconsider the Treasury is standing firm, arguing that tariff restraints will provide an incentive for BT to cut costs and improve its efficiency.

Indeed, the Government this week toughened its position by withdrawing an earlier concession which would have entitled BT to raise tariffs by only 2 per cent less than the RPI if the latter rose by less than 3 per cent annually.

After months of intensive negotiation BT appears to have resigned itself to government proposals to give it a capital structure with a higher proportion of debt than it had been seeking.

The balance sheet ratios would be 60/40. Continued on Page 20

Turkey re-opens bidding on deal 'won' by ITT

By Jason Crisp in London and David Tonge in Istanbul

NEGOTIATIONS on a \$300m telecommunications order for Turkey, which ITT claimed it had won earlier this month, are being re-opened.

"We have made no final decision," Mr Turgut Ozal, the Turkish Prime Minister, told the Financial Times yesterday. "We are still open to all the companies," he added.

L. M. Ericsson of Sweden and Siemens of West Germany are the other main competitors. The Swedish company argued earlier this week that the contract had not been awarded and that it was continuing to bid.

ITT insisted last night however, that it had won the contract. Mr Bernard McFadden, president of ITT Africa and Middle East said: "The letter of award issued on April 5 states a decision has been made and that Bell Telephone Manufacturing (ITT's Belgian subsidiary) has been awarded the tender."

Senior Turkish Government officials yesterday accused ITT of making a premature announcement. But ITT said its press release on the contract had been approved by the appropriate officials.

The five-year contract is for half of Turkey's new digital telephone exchanges which are being installed as part of a \$6bn scheme to modernise the country's telephone network. ITT believed that it was in a strong position to win total orders of \$900m in Turkey.

Turkish officials said the Government had initially awarded the contract to ITT because it believed the company could help persuade the U.S. Congress not to make payment of U.S. aid dependent on Turkish concessions over Cyprus. Late last month the U.S. Senate foreign relations committee insisted that \$215m of the \$934m aid proposed by the administration for Turkey, in fiscal 1985, be linked to Turkish willingness to let Greek Cypriots resetttle in an area occupied by Turkish troops in 1974.

Siemens and Ericsson say they are ready to offer better terms than previously. They also say that the letter of award to ITT was unusual as it had not been approved by the board of the PTT, the national communications authority or Teletas, the PTT's subsidiary involved.

Ericsson-Turk, the Swedish company's local affiliate, says its new offer will be around 10 per cent below its previous one. Siemens says that it has written to the Government complaining at not being approached so that it could improve its terms.

Thomson and Philips seek computer pact

BY PAUL BETTS IN PARIS

THOMSON and Philips, the French and Dutch electronics groups, are working towards a major agreement for co-operation in the growing European market for personal computers.

Discussions between Thomson and Philips over the development of a common standard for personal computers were advancing and could lead to an agreement in the next two to three weeks, M Jean Gerotwohl, president of Thomson's personal computer division, said yesterday as the state-owned French group unveiled its new line of personal computers.

Thomson's two new products include the M05 personal computer which will retail in France at Ffr 2,390 per unit, and the more powerful T07-70 which will be sold at Ffr 3,490 per unit.

Thomson officials said that the discussions with Philips were initially focusing on the M05 personal computer, with the French company considering building these personal computers for the Dutch group and eventually selling Philips a licence.

M Gerotwohl indicated, however, that Thomson was seeking a broad collaboration as possible in personal computers with Philips. He suggested an association between the two electronics groups would constitute a significant alliance able to develop a European personal computer industry on a world scale.

He thought the Philips-Atari discussions involved the videogame sector rather than a Philips takeover of the U.S. company. But he said: "If Philips bought Atari, why should we not buy Atari with them?"

Thomson already collaborates with Philips in the videogame field. Thomson is hoping to sell between 100,000 and 120,000 of its two new personal computers this year. M Gerotwohl said Thomson's Continued on Page 20

Sweden offers novel \$800m U.S. issue

BY MARY ANN SIEGHART IN LONDON

A FURTHER push towards deregulation of U.S. financial markets came yesterday as Sweden launched an \$800m borrowing package which combined the U.S. capital markets with commercial bank lending.

Under existing law, commercial banks which take deposits from the public are not allowed to underwrite or distribute securities. The 50-year-old Glass-Steagall Act has come under increasing pressure in the last few years, however, and Sweden's deal allows commercial banks to act as underwriters in all but name.

Sweden is borrowing the \$800m through a floating rate note (FRN), which is a bond whose interest payments are pegged to short-term interest rates. Lead manager Solomon Brothers, the U.S. investment bank, claims it is the largest FRN seen in the U.S. bond market.

The money will be used to repay an existing, much more expensive bank credit which was arranged by Chase Manhattan in 1981. The interest saving on the bonds is up to 1 percentage point.

Though the final maturity is seven years, investors can have their bonds redeemed every year. Salomon Brothers will try to resell these bonds to other investors. If it fails to do so, a group of commercial banks, led by Chase Manhattan, will lend the balance of the money back to Sweden at slightly more expensive terms, while holding the surplus bonds in trust as security. Since Sweden could not issue a seven-year bond on these terms without the yearly redemptions, the commercial banks are indirectly underwriting the issue.

Continued on Page 20
Eurobonds, Page 44

Europe	2-3	Euro-options	37
Companies	21	Financial Futures	43
America	6	Gold	42
Companies	21	Int. Capital Markets	44
Overseas	4	Letters	20
Companies	22, 24	Lex	19
World Trade	8	Management	13
Britain	10-11	Market Monitors	33
Companies	28-28, 30-32	Men and Matters	18
Agriculture	42	Mining	43
Arts - Reviews	14	Money Markets	16-17
World Guide	14	Property	42
Commodities	42	Raw materials	33, 36
Crossword	42	Stock markets - Buenos Aires	33, 36
Currencies	43	- Wall Street	33-36
Editorial comment	43	- London	33, 37-39
Eurobonds	44	Technology	46-41
		Unit Trains	46-41
		Weather	20

Catalonia: electors prepare homage and abuse 3

Dominican riots: is the IMF squeezing too hard? 6

Management: Mather & Platt's quest for quality 13

Editorial comment: British Steel; export finance 18

Creusot-Loire: why the cash was cut off 18

Sikh extremism: "violence is morally right" 19

Lombard: private jobs for public servants 19

Lex: ICI; House of Fraser; Blue Circle; markets 20

W. Germany: Bavarian banks outgrow regional status 22

Technology: toy makers profit by invention 25

MAYFAIR W1 GROSVENOR STREET

A SUPERIOR HEADQUARTERS OFFICE BUILDING WITH PRIVATE CAR PARKING

27,000 sq. Ft. TO BE LET

All enquiries Ref. 9/P7M



Hillier Parker

May & Rowden

77 Grosvenor Street, London W1A 2BT
Telephone: 01-629 7666
also City of London Edinburgh and Overseas

EUROPEAN NEWS

French unemployment forecast to rise more quickly than expected

BY PAUL BETTS IN PARIS

UNEMPLOYMENT IN France will rise this year by 20,000-30,000 a month, warns the state statistics institute, Insee.

This rate of increase is far higher than recent government forecasts of about 10,000 a month. It will also make it impossible for the Government to hold the jobless figure to around 2.45m this year.

The current wave of industrial restructurings, the general softness of the labour market, and the increase in the number of people looking for their first job could all combine to produce a jobless total of 2.6m by the end of the year, according to M Jack Ralite, the Communist Secretary of State for Employment.

Renault, the state-owned vehicle manufacturer, yesterday announced 3,500 job losses in its Paris plants by early retirements, and another 3,325 job cuts are planned by the Normed shipbuilding group.

These announcements coincided with the visit of

M Laurent Fabius, the Industry Minister, to the depressed steel region of Lorraine yesterday. The area has been the scene of violent protests in recent weeks over the Government's tough restructuring plan for the steel industry.

M Fabius said yesterday that 4,000 jobs would be created in Lorraine, half of them in the public sector.

However, while the employment outlook is depressed, the latest Insee economic survey published yesterday paints a more encouraging picture of other key aspects of the economy.

The inflation rate is expected to be 6.5 per cent this year, the lowest since 1971, although higher than the 5 per cent official target.

Teh financial performance of French companies is also expected to continue to improve this year. Insee estimates that corporate investments will increase by 2 per cent after three years of decline.

Bank governor supports reduction in foreign debt

BY DAVID HOUSEGO IN PARIS

THE GOVERNOR of the Bank of France, M Renaud de la Geniere, yesterday threw his weight behind pressure on the French Treasury for policies aimed at reducing France's foreign debt.

In a personal statement accompanying the annual report, he said that France should aim for a surplus on its current account in order to reduce the size of its foreign indebtedness. Latest figures from the Ministry of Finance put France's medium and long-term debt at the end of last year at FFr 451bn (\$55bn).

Unofficial estimates are that France will continue to run a current account deficit this year of about FFr 20bn. Ministers are at odds over whether to give priority to achieving a current account sur-

plus or to maintaining a slightly higher economic growth rate even if this means adding to France's foreign debt.

M de la Geniere, who makes only rare statements of policy, says firmly that it is necessary to achieve a progressive cut in the country's indebtedness.

He also shows some unease at the still substantial growth in money supply M2 last year. He says the 10 per cent expansion in M2 remained high considering that gross national product only grew in volume terms by 1 per cent in 1983. It was thus a factor in maintaining inflation last year at a 9.6 per cent rate or 4-5 percentage points higher than that of other industrialised countries.

Moscow to revise its vision of the future

By Anthony Robinson

THE SOVIET President, Mr Konstantin Chernenko, has announced that the Communist Party is to draft a new version of its blueprint for the future. The long-term programme will be drafted by a special commission of the central committee and completed in time for the next party congress, due to take place early in 1984.

The new programme, which Mr Chernenko stressed should be "above all realistic," will replace the highly ambitious goals set out in the existing party programme drafted by Mr Nikita Khrushchev in 1961 but quietly dropped following his removal from office in October 1964.

The 1981 programme promised that the Soviet Union would overtake the United States in economic terms by 1980. Like so many of Mr Khrushchev's schemes, the programme was harshly criticised after his fall. But some of the key targets have actually been achieved.

The Soviet Union produces for example, far more coal and steel than the United States. It is also the world's largest producer of oil, and the second largest producer of gas, gold, diamonds and many other precious and semi-precious or strategic metals.

Unfortunately, the huge Soviet steel and coal production figures are no longer seen as true measures of Soviet economic strength but as indicators of the technological backwardness of the Soviet economy.

The U.S. and other Western economies moved rapidly away from such industries into electronics, chemicals, computers, bio-chemistry and other high technology sectors in which the Soviet Union lags behind.

On the key food and agricultural front, the Soviet Union, far from achieving the abundance promised in the 1961 programme, is obliged to import between 30m and 40m tons of grain and other food products from the West every year.

West German forces falter against the Pill

BY JAMES BUCHAN IN BONN

CHANCELLOR Helmut Kohl's coalition government in Bonn this week took a tentative bite at a political bullet—keeping the West German armed forces up to strength in the face of a weak birth rate.

The announcement that the Bonn Defence Ministry is reckoning on up to 15,000 women volunteer soldiers to help fill the gaps that will appear in the ranks from 1987 is causing unease not only in the Social Democrat and Green opposition but in the coalition itself.

The prospect of a drastic contraction of Nato's largest continental force from its peacetime level of 495,000 has been

on the cards since the widespread use of oral contraception brought a sharp fall in the birth rate at the end of the 1960s.

At its present strength, the Bundeswehr (army, navy and airforce) and the paramilitary services need 250,000 conscripts a year. However, the so-called Pillenkick (downturn caused by the Pill) means that from 1987 fewer than a quarter of a million young men will be entering their conscript year.

Unless something is done, the Bundeswehr could shrink to around 300,000 men by the 1990s, which could have decisive effects on Nato's conventional ability to withstand a

Warsaw Pact attack.

Herr Hans-Dietrich Genscher, the foreign minister ever on the look-out for new themes, has let fall warnings that unless decisive action is taken the negotiations between the alliances on balancing conventional forces in Europe could degenerate into farce. The Soviet Union will just sit back and watch Nato forces shrink, the Bonn Foreign Ministry argues.

Herr Manfred Woerner, the Defence Minister, is finding the problem no less intractable than Herr Hans Apel, his Social Democrat predecessor. A major reduction in strength would in-

crease dependence on nuclear weapons while all attempts to plug the gap will be unpopular and costly.

At present, the DfW Ministry is shuffling in terms of a package with the first legislation to go through this year. The package will comprise most or all of the following:

- Extension of military service from 15 to 18 months
- Loosening of fitness criteria
- More attractive terms for longer-term and professional service
- Women volunteers

It is reckoned that these measures together should allow a Bundeswehr strength in the

1990s of more than 400,000.

Herr Peter Kurt Wuerzbach, state secretary at the Defence Ministry, said earlier this week that the first 1,000-1,500 women volunteers could begin service next year in support roles.

However, the authors of the West German constitution, with bad memories of the total mobilisation at the end of World War II, state categorically that women "may not render service involving the use of arms." The opposition is already arguing that in modern warfare the distinction between combatants and support groups may be impossible to maintain.

IG Druck calls another round of print strikes

By Rupert Cornwell in Bonn

IG DRUCK, the West German print union in the forefront of the campaign for a 35-hour-week, yesterday organised a new wave of "warning" strikes which will seriously interfere with newspaper production, particularly in West Berlin.

At the same time, the union grudgingly agreed to a further round of talks with employers on May 2, but made clear that, in its view, these offered little chance of progress towards agreement on a new wage deal.

According to IG Druck yesterday, some 8,500 of its total 185,000 membership took part in the stoppages which means that papers in Berlin, as well as in several other parts of the country will appear today at best in an extremely reduced form.

Print industry employers are still showing little sign of resorting to retaliatory lockouts. But they angrily claimed again yesterday that IG Druck had called strikes even when it had not secured the required 75 per cent approval of the workforce.

Management has also reacted with comparative equanimity to the strike ballots, involving some 800,000 engineering workers, which the militant IG Metall union is organising between May 3 and 8.

This is despite the fact that the carefully chosen targets include the major car companies

New line on Italian pay decree

BY JAMES BUXTON IN ROME

THE ITALIAN Communist Party is unlikely to use the same obstructive parliamentary tactics, which prevented approval of the Government's decree cutting wage indexation, against its slightly-amended successor. This was stated yesterday by Sig Giorgio Napolitano, the party's leader in the Chamber of Deputies.

But the party will seek to change the new decree, introduced just before Easter, in order to protect the position of the workers whom it affects, he said in an interview with the Communist Party newspaper, L'Unita.

The first decree, under which the Government of Sig Bettino Craxi limited by about one-third the amount of protection

against inflation given by the Scala Mobile wage-indexation system, was not converted into law because it did not receive final approval in the Chamber of Deputies before its 60-day life expired.

This was due mainly to exceptionally obstructive procedures by Communist MPs.

The new decree should have much the same economic effect as its predecessor, but will be in force for six months instead of a year and includes other concessions.

Sig Napolitano said that the party's attitude to the new decree was different because of the success it had achieved against the first. "We will take that into account," he would be absurd not to," he

said.

But the party would try to amend the central part of the decree, restricting indexation, and would seek compensation in 1985 for Scala Mobile payments lost in 1984.

Even though the Communist opposition should be slightly milder this time, the decree still faces serious obstacles between now and June 16 when it, too, will expire if not approved.

Because of mismanagement by the parties of the ruling coalition, the Communist opposition has been able to require that the decree be submitted for approval to three rather than just one parliamentary committee, which will take up further time.

Poles urged to emulate German links

By Christopher Bobinski in Warsaw

POLAND'S GOVERNMENT was accused yesterday of doing little to foster relations with Poles living abroad. Mr Edmund Osmańczyk, an independent member of Parliament, quoted by way of contrast the improved relations between the two German states.

"I watch with envy how consistently the two German societies, with their differing systems, are working to build bridges— even now when their territory has been turned into a firing range for SS20s and Pershing missiles," he said.

Mr Osmańczyk accused the state-controlled mass media of remaining silent about Poles in various parts of the world, a reference to those still living in the Soviet Union, and "attacking those who live in the West."

Ruiz Mateos retained

A Frankfurt court confirmed yesterday that the fugitive Spanish financier, Sr Jose Maria Ruiz Mateos, will be held in custody awaiting extradition papers from the Spanish authorities, Reuter reports.

Danish exports set for growth

BY OUR COPENHAGEN CORRESPONDENT

CONTINUED SOLID growth in Denmark's industrial exports, combined with fast falling inflation over the next two years, is forecast in the half yearly report of the Danish Government's Economic Secretariat.

Industrial exports, which rose by 6 per cent last year, should increase by another 7 per cent this year if the West's slow economic recovery continues.

The inflation rate of 7 per cent in 1983 is expected to fall steadily from an estimated 5.75 per cent this year to 3.5 per

cent in 1985. Unemployment is likely to drop only slightly, from 10.7 per cent last year to 10.25 per cent this year and 10 per cent in 1985.

The Secretariat foresees the balance of payments deficit deteriorating from DKr 10.85bn (£783m) in 1983 to DKr 12.3bn (£885m) this year, falling again to around DKr 10.8bn by the following year. The budget deficit, reduced last year for the first time in 10 years to DKr 55bn, is forecast to fall to DKr 50bn this year and to DKr 45bn

by next year.

Mr Anders Andersen, the Economy Minister, said that the forecasts for 1985 assumed that forthcoming collective bargaining negotiations for next year kept annual pay increases at a maximum of 3.5 per cent.

The report has taken into consideration the anticipated effects of the latest package of austerity measures announced by the Government on Wednesday. Those call for DKr 1.5bn cuts in public expenditure this year and DKr 4bn in 1985.

FINANCIAL TIMES, USPS No 19060 published daily except Sundays and holidays. U.S. subscription rate \$20.00 per annum. Second class postage paid at New York NY and at additional mailing offices. POSTMASTER: send address changes to FINANCIAL TIMES, 14 East 60th Street, New York, NY 10022.

NUDGE NUDGE, WINK WINK...

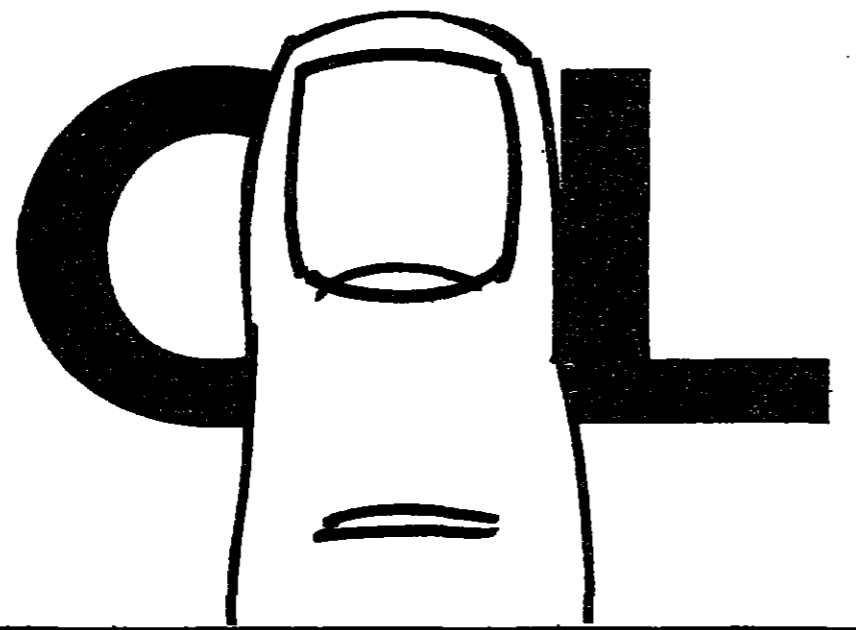

Increasingly Scotland's youngest new town is attracting major investment from Scotland's youngest industries.

Some we can talk about such as our major developments in the High Tech industries with firms like Prestwick Circuits, SCI (UK) Ltd and Climax International. Also the designation of Prestwick, just 10 minutes along the coast as Scotland's only FREEPORT.

Some we can only speculate on, such as the granting of an offshore drilling licence to B.P. and the potential growth that this will give to Scotland's west coast.

Irvine

Mike Thomson
Commercial Director,
Irvine Development Corporation,
Perceton House, Irvine, Scotland KA11 2AL.
Telephone (0294) 214100.
Telex: DEVIRV IRVINE 778984.

Come and join the new wave in Britain's only seaside new town

This announcement appears as a matter of record only.

NEW ISSUE

April, 1984

The Mortgage Bank and Financial Administration Agency of the Kingdom of Denmark

Yen Bonds No. 3 (1984) Series 92
Guaranteed by the Kingdom of Denmark
15,000,000,000 Japanese Yen
7.4% Bonds due 1994

Daiwa Securities Co. Ltd.

Yamaichi Securities Company, Limited	The Nomura Securities Co., Ltd.	The Nikko Securities Co., Ltd.
The Nippon Kangyo Kakumaru Securities Co., Ltd.	New Japan Securities Co., Ltd.	Wako Securities Co., Ltd.
Kokusai Securities Co., Ltd.	Sanyo Securities Co., Ltd.	Wako Securities Co., Ltd.
Merrill Lynch Securities Company, Tokyo Branch	Smith Barney, Harris Upham International Incorporated, Tokyo Branch	Dai-ichi Securities Co., Ltd.
Salomon Brothers Asia Limited, Tokyo Branch	Goldman Sachs International Corp., Tokyo Branch	Tokyo Securities Co., Ltd.
Okasan Securities Co., Ltd.	Osakaya Securities Co., Ltd.	Tokyo Securities Co., Ltd.
Yamatane Securities Co., Ltd.	Bache Securities (Japan) Ltd., Tokyo Branch	Kidder, Peabody & Co. Incorporated, Tokyo Branch
Marusan Securities Co., Ltd.	Koyanagi Securities Co., Ltd.	Toyo Securities Co., Ltd.
Ichiyoshi Securities Co., Ltd.	The Kaisai Securities Co., Ltd.	Mito Securities Co., Ltd.
Nichiei Securities Co., Ltd.	Vickers da Costa Ltd., Tokyo Branch	Kosei Securities Co., Ltd.
Takagi Securities Co., Ltd.	The Chiyoda Securities Co., Ltd.	The Toko Securities Co., Ltd.
Towa Securities Co., Ltd.	National Securities Co., Ltd.	Hinode Securities Co., Ltd.
Maruman Securities Co., Ltd.	Meiko Securities Co., Ltd.	Naigai Securities Co., Ltd.
The Nippon Securities Co., Ltd.	Okatoku Securities Co., Ltd.	Utsumiya Securities Co., Ltd.
Jardine Fleming (Securities) Ltd., Tokyo Branch	The Izumi Securities Co., Ltd.	Daito Securities Co., Ltd.
Daifuku Securities Co., Ltd.		Chuo Securities Co., Ltd.
The Shinyei Ishino Securities Company, Limited		Hiroaka Securities Co., Ltd.

Den Danske Bank af 1871 Aktieselskab **Privatbanken A/S** **Copenhagen Handelsbank A/S**
Amro International Limited **Citicorp International Bank Limited** **County Bank Limited**
Hambros Bank Limited **Manufacturers Hanover Limited**
Swiss Bank Corporation International Limited **Westdeutsche Landesbank Girozentrale**

EUROPEAN NEWS

Electors prepare homage and abuse in Catalonia

David White reports from Barcelona on a two-sided campaign for Sunday's regional election

THE TWO sides in Sunday's election in Catalonia stand opposite each other on the Plaça de Sant Jaume in Barcelona's Gothic quarter. On one side is the Generalitat, the autonomous regional government, run by the conservative Catalanist party Convergència i Unió. On the other side is the Socialist-led town hall.

The square in between has become a Catalan version of London's Speaker's Corner, where everybody seems to demonstrate. Protests are directed to one side or other of the square, depending on the cause. Around the corner, a shopkeeper demonstrates Catalan business initiative by doing a roaring trade in plastic whistles and trumpets for the demonstrators.

Tossing charges of irregularities back and forth, Convergència and the Socialists have dominated the three-week campaign for the region's parliament. They can safely be expected to take most of the seats.

The remainder are being fought for by the right-wing Popular Alliance, attempting an American-style attempt to rake in former centrist voters, the weakened Catalan branch of the Communist Party—the PSUC—and the veteran Esquerra Republicana, the main force behind the home rule statute which Catalonia enjoyed between 1932 and 1939, but now only a shadow of its former influence.

A dozen other parties ranging from Greens to varying hues of extreme Left complete the field. A particular flavour is given to the campaign by the fact that, in contrast to normal commercial advertising, which is in Spanish, the election posters are mostly in Catalan.

ment statute granted at the same time as the Basque country's. Surprisingly, in view of Barcelona's left-wing tradition, Convergència came out ahead of the Socialists and formed a fragile minority government.

With the Socialists now in power in Madrid, pre-ballot polls show Convergència turning the tables again and keeping its lead in the 135-seat parliament.

At the centre of the confrontation is the chubby figure of Sr Jordi Pujol, 53-year-old president of the Generalitat and founder of the original Convergència, which merged with an older Christian Democrat party, now covers a broad spectrum from left-of-centre to the right.

The election is really between *pseudismo* and *anti-pujolismo*. Sr Pujol, politically active since his teens and jailed under Franco for singing a patriotic song, has a messianic side, resented by the Socialists, who challenge his claim to personify Catalan interests.

When Sr Pujol speaks of "this country," he means Catalonia. Fluent in English, French or German, he has carried out a prestige campaign for the region outside Spain, emphasising its "European" outlook. He takes pride in its climate of stability and tolerance.

Compared to the Basques, whose brand of nationalism is less moderate and more exclusive, the Catalans have had a smooth return to autonomy. The Basque country has obtained more financial independence, but Catalonia has moved further in some areas.

Language is one. All schoolchildren now learn Catalan, and Sr Pujol sees the day in 15 or 20 years' time when everybody over 40 will know both that and Spanish well. On the region's new TV3 channel, viewers can

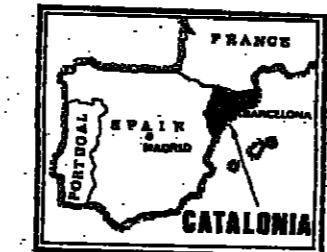

Sr Jordi Pujol (right): Proud of Catalonia's political stability



following "Dallas" dubbed into Catalan.

In other fields, Sr Pujol says his administration has brought major improvements in infrastructure and social welfare and has helped to steer struggling local industries towards foreign markets. But it has been hampered by a "regressive tendency" in Madrid over regional self-government and has still not received all the powers provided for under the autonomy statute.

Now that 15 other autonomous regions have been set up in the rest of Spain, Sr Pujol says the Socialist government does not know what to do next with the

devolution process.

Catalans argue it is not their fault if the rest of the regional autonomy structure has so far proved clumsy and expensive.

Defending the Socialist line is Sr Raimon Obiols, a 44-year-old Barcelona geologist. Originally a left-winger, now cast in a tamer role, he has to fight against the idea of being a second-best candidate. Other Catalan Socialists such as Sr Narcís Serra, former Mayor of Barcelona and now Defence Minister, have more standing in the region, but local party leaders contend that Sr Obiols is better placed for not being directly involved in the central government.

The region's socialists are a peculiar mix. The leadership is drawn mainly from the Catalan intelligentsia (Sr Obiols' father was a prominent artist), while the electorate is made up mostly of non-Catalan-origin workers, who streamed in during the prosperous 1980s and now make up two-fifths of the population.

The party accuses Sr Pujol of being divisive and aiming his policies at the Catalan-origin majority.

Relations across the square have been difficult. The new mayor, Sr Pasqual Maragall, complains about the Generalitat's over-assertiveness. As an institution, the Generalitat dates back over 600 years, but it has had long absences.

Sr Maragall says it lacks able administrators, wants to buy up everything, is duplicating facilities already in existence, is too concerned with show, for instance ordering helicopters instead of fire engines, and is imposing "a bit too much official culture."

The Socialists also criticise the Catalan government's response to the economic crisis, which has brought a faster rise in unemployment here than in the rest of Spain, and are proposing a tripartite pact with industry and unions.

Sr Pujol has had to extricate himself from a controversy surrounding the collapse of

Banca Catalana, an industrial banking venture he promoted.

But voter turnout is expected to be on his side, this election being of more evident concern to his supporters than to the Socialists'. Polls show the Socialists falling well below their 1982 general election score of 48 per cent, and Convergència beating its previous 30 per cent record.

The question is whether Convergència can now form a majority government with Esquerra, on which it has been relying for support in the parliament, or whether it will be forced into an alliance with one of the main Spanish parties.

Sr Maragall believes a pact between the Socialists and Convergència could eventually emerge—although not in the short term. This would be an important precedent at the national level.

The election result will also have an important bearing on the future of the "reformist" project being mounted nationally by Sr Miquel Roca, Convergència's spokesman in the Madrid parliament and effective party leader. Existing so far only on paper, this plan seems to be aimed at forming a "hinge" political force like the West German Free Democrats. After the disappearance of the former Spanish government party, the CD, a year ago, the fight for the centre ground in Spanish politics begins in Catalonia on Sunday.

MIRAGE BUILDINGS LIMITED. A UNIQUE BUILDING SYSTEM... YOUR RAW MATERIALS FOR OUR BUILDINGS. Includes images of buildings and lists of materials like OIL, RICE, etc.

TWA's low fares to America—right up your street.

Grid of TWA flight fares to various US cities: New York (£329), Los Angeles (£449), Boston (£319), Phoenix (£412), Philadelphia (£349), etc. Includes images of street signs for Broadway, Hollywood, Beacon St, Scottsdale Rd, Chestnut St.

Nobody has lower fares to over 50 cities. If you're visiting America this year, the airline to take you there is TWA. TWA really knows how to look after you. And no other scheduled airline has lower fares to over 50 cities. You get real value for money. Great service on the ground and in the air. And a really big welcome in America.

Yugoslavs rush to beat end of price controls

BY ALEKSANDAR LEBL IN BELGRADE AND DAVID BUCHAN IN LONDON

YUGOSLAVS ARE rushing to the shops this week in order to beat the massive price increases that are expected to take effect in three days time.

The lifting of price controls comes two months earlier than the government of Mrs Milka Planinc originally planned, and is at the insistence of the International Monetary Fund, which this week gave final approval to a new \$400m loan to Yugoslavia.

A fresh wave of inflation is expected, as some producers have already announced price increases of more than 100 per cent. This will give a further boost to inflation which this spring barely slowed from a 58 per cent annual rate last year.

The IMF, however, argued that administrative controls did not attack the root causes of Yugoslav inflation—lack of competition in the fragmented domestic market—and distorted relative efficiencies and inefficiencies in the economy.

The prices move comes at an awkward moment for the Government, which is on the verge of mid-term ministerial

changes. Halfway through her four-year term, Mrs Planinc is losing her Foreign Minister, Mr Laza Mirovic, and Interior Minister, Mr Stane Dolanc, who are due to join Yugoslavia's collective presidency in mid-May. They are to be replaced respectively by Mr Raif Dizdarevic and Mr Dobroslav Cukanec. Of more importance to Yugoslavia's internal and external management is the retirement from government of Mr Zvonko Dragan, the extremely capable Vice Premier in charge of the economy, and Mr Janko Smole, who for the past two years has conducted debt negotiations with Western banks. Mr Dragan's job is to be filled by Mr Borislav Srebic, another Vice Premier, while Mr Smole's debt negotiating role is to be shared among other cabinet members.

From next week, the prices of some 55 per cent of all goods and services will be decontrolled. The Government will retain direct control over the prices of a few key commodities, while some other goods and services will be subject to regulation by agreement between wholesaler and retailer.

Roof falls on Iron Bella's Black Sea gold mine

BY ANTHONY ROBINSON

"IRON BELLA" Borodinka made a fortune of at least 500,000 (nearly £500,000) in the 10 years she ran the state-owned restaurants in the select, Soviet Black Sea resort of Gelendzhik. Now she faces the firing squad after being found guilty of bribetaking and embezzlement, according to the Moscow newspaper, Sovetskaya Rossiya.

If the sentence is carried out she will be the first woman victim of the police campaign, begun more than a year ago on the orders of the late President Yuri Andropov, to stamp out rampant crime and corruption.

Black sea resorts with their mild climate, good food and wines, and southern traditions of hospitality have been the favoured watering holes of the Soviet elite, with their often palatial villas, servants and modern imported luxuries.

Iron Bella, as she was nicknamed locally, catered to their tastes. She entertained local and national party bosses, and their underworld contacts, and laid on sumptuous meals.

The conspicuous consumption and abuse of office, which has always been a feature of the lifestyle of parts of the Soviet elite, assumed growing proportions in the last years of former President Leonid Brezhnev—until the war on corruption declared by Mr Andropov made it a key element in the inner party power struggle.

Since Mr Andropov's death and the elevation of Mr Konstantin Chernenko, however, several of the highly placed victims of the Andropov purges, like Mr Mikhail Sicholokov, the former Interior Minister, have been quietly released from prison and restored to their privileges.

Chemical arms proposals condemned by Moscow

GENEVA—The Soviet Union said yesterday that the United States' proposed treaty outlawing chemical weapons was not only unacceptable but would "set negotiations on a chemical weapons ban back by many years."

Mr Viktor Issraelyan, the chief Soviet delegate, told the 40-nation Geneva Disarmament Conference that the U.S. draft, tabled here last week by Vice President George Bush, was aimed not at attaining agreement but at permitting the U.S. Defence Department to implement a \$10bn chemical rearmament programme. "Putting forward demands for unimpeded access to the territory of other states continues to block the achievement of agreements on a chemical weapons ban," he said.

"Why was it necessary for the United States to put forward such a proposal deliberately unacceptable to the Soviet Union and many other states?" asked Mr Issraelyan.

"We are deeply convinced it was done merely to try to cover by the big noise of publicity around the American draft what the American Administration is really engaging in—intensive preparations to implement a \$10bn chemical rearmament programme proclaimed by President Reagan," Reuter

OVERSEAS NEWS

New Lebanese PM asked to form national government

BY NORA BOUSTANY IN BEIRUT

LEBANESE President Amin Gemayel yesterday appointed Mr. Bassid Karami, a Sunni Moslem, as Prime Minister and asked him to form a national union government which will have the arduous task of steering Lebanon out of its crisis and carry out political reforms.

Hope of dialogue fades as Punjab death toll mounts

BY JOHN ELLIOTT IN AMRITSAR

THREE more people were killed in the Punjab yesterday in two separate clashes, bringing to 181 the total number of deaths in the state since the Indian Government declared presidential rule from New Delhi nearly six months ago.

Wellington offers China Antarctic research site

By Dal Hayward in Wellington

NEW ZEALAND has offered China a site for a permanent research base in the Antarctic. China has been given the choice of seven locations in the Ross sea area which comes under New Zealand's control.

Angolan hostages freed

The Angolan guerrilla movement, Unita, yesterday released 99 hostages who have been held in southern Angola but 16 British nationals are still held captive, our Johannesburg correspondent reports.

Pretoria to enforce pact

South Africa will implement the terms of its non-aggression pact with Mozambique "to the letter," the South African Prime Minister P. W. Botha, said yesterday.

Dock strike ends

TOKYO — Dockworkers at Japan's 10 major ports called off their strike after labour and management reached agreement on wage and job security disputes.

ADB accused of excessive interest rates

BY PETER MONTAGNON IN AMSTERDAM

THE ASIAN Development Bank was accused by several of its developing country members yesterday of charging excessive interest rates on its loans while offering inadequate opportunities to supply local material for regional development projects.

Aid loss 'will ruin' weak African states

BY ANDREW GOWERS

AFRICAN countries are worried by what they see as the West's growing reliance on the private sector to provide development assistance, and the corresponding decline in grant aid, according to the Arab Bank for Economic Development in Africa (Badea).

Howe calls on Japan to act on imports

BY JUREK MARTIN, FAR EAST EDITOR, IN TOKYO

SIR GEOFFREY HOWE, the British Foreign Secretary, yesterday suggested that the biggest contribution Japan could make to ease trade tensions was for the whole nation to become more import conscious.

resources had gone to developing countries. The statistics lead us to the conclusion that our bank is simply a multilateral export bank for its developed member countries," he said.

disposal of soft-loan organisations such as the IDA (International Development Association) will lead to ruin for the weak and fragile economies of the poorest countries in a fairly short space of time.

of interest on commercial borrowings." Mr David Mulford, Assistant Secretary of the U.S. Treasury, told the meeting the bank should contemplate the introduction of a variable lending rate which would minimise its exposure to interest rate swings.

present trend towards co-financing of aid between public bodies such as the World Bank and private lenders. It agrees that co-financing can strengthen and multiply capital investment flows, but warns that it can also have the effect of cutting the poorest countries off from aid altogether.

Meanwhile India, which has applied to borrow from the bank for the first time, seems likely to receive less than the \$2bn in loans it is seeking over a space of five years. A behind-the-scenes consensus has emerged here that India should be allowed to borrow a smaller amount, though details will be decided later this year.

Philippine plan to reduce deficit

By Peter Montagnon, in Amsterdam

THE PHILIPPINES is to reduce its current account balance of payments deficit to less than 5 per cent of gross domestic product this year from 8 per cent in 1983 as part of its International Monetary Fund adjustment programme.

Australian unions push for pension programme

By Colin Chapman in Sydney

AUSTRALIAN trade unions have turned their attention to a new target—a national superannuation scheme—now that wages are indexed to the cost of living.

Six hard facts about Pacific Telesis Group.

Advertisement for Pacific Telesis Group featuring six numbered facts: 1. We're organized for tomorrow... 2. We're financially stronger today... 3. We're technologically advanced... 4. We serve a dynamic, growing marketplace... 5. We have a proven management team... 6. We're committed to meeting the needs of investors...

12:03

The Diners flight delay insurance is very nearly worth waiting for.

Fog. Mechanical trouble. Ice on the runway. Or no reason at all! How often have you had to hang around airports waiting for your plane? Too many times!

Diners have made it a little more bearable with the Diners Flight Delay Insurance*. It's free.

All you have to do is to charge your scheduled airline ticket to your Diners Club Card.

If your departure is delayed by four

hours or more you can automatically get up to £75 credit on your Card.

Food and Drink

This can be spent on anything that will make the time pass that little bit more comfortably.

Food. Drink. Hotel bills.

And you can charge the same amount if you should miss a connection because of a delay.

Baggage has an uncanny habit of going astray.

Baggage

Just because your bags disappear down the conveyor belt at the check-in is certainly no guarantee they will meet you at the other end.

No worry.

Should your baggage not turn up at your destination airport within six hours of your arrival, you can charge up to £75 for replacement necessities, and Diners Club will credit your account.

If no baggage arrives within 48

hours of your arrival you can charge another £175.

If your baggage is damaged or lost during any journey overseas, it's covered up to £1,500.

International

The Diners Club Insurance covers a lot more than just baggage and flight delays.

Fortunately there is no shortage of places to use your Card should you unhappily have to claim. Over half a million establishments in over 160 countries accept the Diners Club Card.

And Diners Club offers many more benefits than insurance.

If you travel the world on business, make it your business to find out exactly how much more by posting the coupon below.

*For full details see Certificates of Insurance.

16:04



Diners means business.

For full details of becoming a Diners Club Cardholder, send to Diners Club Ltd., 26 St. James's Sq., London SW1Y 4JY, or more simply telephone (01) 930 2735.

Name _____

Home address _____

Home telephone _____

Business telephone _____

CAB1

AMERICAN NEWS

Brazil election plan narrowly defeated after long debate

BY ANDREW WHITLEY IN BRASILIA

THE BRAZILIAN opposition's constitutional amendment to restore direct presidential elections was narrowly defeated in Congress in the early hours of yesterday morning. But the organisers of the national campaign to end military rule are vowing to fight on. After a 17 hour, often angry, debate, the opposition Bill failed by just 22 votes to get the necessary two-thirds majority in the 479-member Chamber of Deputies, the low house. A block of 55 Government party deputies defected, but it was insufficient to win what would have been a historic victory. The Bill went down amid scenes of considerable emotion in Congress. Many people were openly crying. From the packed public galleries, chants of "the struggle goes on" and "the people in the street will overcome the dictatorship" resounded. The Figueiredo Government now nervously awaits to see how vehemently Brazil's big cities—the scenes of daily major demonstrations in favour of direct elections—will react. If serious disturbances erupt, one possibility is the extension of the emergency powers covering Brasilia and its surrounding region to other cities. Yesterday, opposition party and trades union leaders were meeting to discuss their next steps. In Congress, this is likely to take the form of a sub-amendment attached to the Government's own Bill on direct elections, proposed for 1988. The Figueiredo Bill is currently at the committee stage of its passage through Congress and could come to a full debate and vote next month. The opposition strategy would be to amend it so as to call, once again, for direct elections this year. Attention in the coming weeks is, therefore, certain to remain focused on the battle for the loyalty of the officially created Partido Democrático Social (PDS), which is badly split into several warring factions. In the immediate aftermath of yesterday's Congressional vote, calls were made by some opposition members for a general strike, a step deliberately avoided until now so as not to give the military a pretext for drastic action.

CIA chief 'apologises' after outcry on mining

BY REGINALD DALE

MR WILLIAM CASEY, President Reagan's controversial director of the Central Intelligence Agency, is making a concerted effort to mend fences with an angry Congress, following the outcry on Capitol Hill over U.S. involvement in the mining of Nicaragua's harbours. In a series of meetings with members of the Senate Intelligence Committee over the past two days, Mr Casey has conceded that his cursory and belated briefing of the committee on the mining was unsatisfactory and that future briefing procedures should be improved. Mr Casey was due to attend a closed session of the committee later yesterday, at which both he and a number of committee members hoped to bury

the hatchet. Democratic Senator Daniel Patrick Moynihan of New York nevertheless went ahead on Wednesday with his previously announced intention of resigning as the committee's vice-chairman in protest at what he called Mr Casey's failure to inform the committee fully about the mining. Aides to Mr Moynihan said that Mr Casey had "come as close to an apology as could be expected" and had pressed the senator to continue his past support for U.S. covert aid to the right-wing "Contra" rebels in Nicaragua. The impact of Mr Moynihan's gesture has been reduced by a fairly widespread feeling in Washington that he himself should have pressed Mr Casey more strongly.

Mondale responds to attacks on fund-raising

By Reginald Dale, U.S. Editor in Washington

FORMER Vice President Walter Mondale has found himself obliged to respond to attacks on his presidential campaign's financing methods by instructing his supporters to disband controversial "delegate committees" that have been raising funds on his behalf. Mr Mondale's defensive move came as Senator Gary Hart, his main rival for this year's Democratic presidential candidacy, followed up a win in Tuesday's Vermont caucuses with a 48 to 50 per cent victory over Mr Mondale in Conservative Utah. The consensus among Democratic party officials and strategists, however, was that neither apparent setback for Mr Mondale should be taken too seriously, and that he might even wrap up his bid for the nomination in the coming two weeks. Sources close to Mr Hart said that some of his top advisers were now urging the Colorado senator to pin his hopes on a "two-week strategy" in which he would make a final bid to revive his flagging candidacy in forthcoming votes in Tennessee, Texas, Ohio, Indiana, Maryland and North Carolina, which will be concluded by May 8. If he failed to win at least three out of four victories in those states, Hart strategists said, he would then have to end his increasingly tough attacks on Mr Mondale and tacitly concede defeat. Hardliners in the Hart camp, however, were believed to be arguing that their candidate should maintain his unrelenting attacks on Mr Mondale until the primaries are concluded on June 5. They are still hoping that a strong showing by Mr Hart at the very end of the race might generate enough momentum to upset Mr Mondale on the floor of July's national convention in San Francisco. Mr Mondale asked his delegate committees to close down after both Mr Hart and the Rev Jesse Jackson, the third-running candidate had threatened to turn their fund-raising activities into a major campaign issue. Both candidates have attacked the supposedly independent committees for engaging in questionable, if not illegal, electoral practices on Mr Mondale's behalf.

IMF-style austerity spells trouble for region's governments, says Canute James Political storm clouds in the Caribbean sky

THIS WEEK'S riots in the Dominican Republic, sparked by economic policies designed to fulfil the terms of an International Monetary Fund loan, will force several neighbouring governments to think more than twice about their relations with the Fund.



Police move in on a protester during riots in Santo Domingo

Yet, given the parlous state of their economies, some governments, such as those of Jamaica and Guyana, appear to have little option but to turn to the IMF if they are to get any short term economic relief. The prospect of running battles, in the street over food prices, however, could embolden the region's recipients of credits from the Fund to ask for some stay in executing unpopular economic changes. Like the Dominican Republic, most Caribbean countries are facing chronic shortages of hard currency because of falling earnings from a narrow range of raw material and commodity exports. National coffers are empty because savings from sugar, bananas, bauxite and tourism have slowed to a trickle.

This week's flare-up in the Dominican Republic is the second in as many months. Some governments in the region which might see a warning in the carnage and destruction in Santo Domingo, are pressed for time to consider whether to accept an IMF programme.

The policies of the international institutions need to be reviewed in terms of whether they will continue to be cast in concrete or whether they will have more flexibility. Mr Edward Seaga, the Prime Minister of Jamaica, whose administration has had three years of contentious dealings with the IMF, "I refer in particular to the IMF and the World Bank. The dilemma faced by President Salvador Jorge Blanco of the Dominican Republic starkly illustrates the deep-seated concerns of several regional governments."

The Fund is willing to give the country credits of \$460m, but the Dominican Government has been wary of the political consequences of acceptance.

The IMF was asking that payment for all imports, including oil, representing a total of \$800m, be moved from the peso's official rate of exchange, which is at par with the dollar, to the lower "parallel" rate of three pesos to the dollar. This would constitute a de facto devaluation. But President

Blanco is on record as saying that he will not devalue the peso. In fact, he did make a concession to the IMF by agreeing to move all imports except for oil, worth about \$350m, to the parallel rate, thus sharply driving up prices. Cash from the IMF is not all the country needs. Creditor banks which are willing to grant new loans of \$800m to help the Government continue servicing its \$2.6bn foreign debt, are unwilling to give the green light until the IMF's "seal of approval" is in the form of an economic policy agreement is in place.

Behind the Dominican administration's reluctance there are also political calculations. Jockeying for position for the 1986 presidential elections has started, and there has been growing concern within the ruling Partido Revolucionario Dominicano at the likely effect on its candidate of unpopular economic measures. No Caribbean leader is likely to be more concerned at the developments in the Dominican Republic than Mr Seaga is.

Santo Domingo remains tense



SANTO DOMINGO—Food-price riots flared again in the Dominican republic as President Salvador Jorge Blanco vowed to continue in office, after a series of violent clashes in which nearly 50 people have been killed.

In a special address to the nation, Sr Blanco made no mention of steep increases in food prices which sparked off the riots four days ago and said the armed forces would suppress disturbances "at all costs."

Among the first to criticise the speech was Dominican Communist Party (PCD) spokesman Sr Narciso Est Conde who said street violence would be stepped up in an effort to force the Government to repeal the price rises. A week ago, the price of basic foodstuffs was raised by

up to 50 per cent as part of a series of austerity measures designed to comply with the terms of a \$450m loan from the International Monetary Fund.

Since then, 50 people have died, more than 100 injured and some 4,000 have been arrested in the worst civil disturbances to hit this Caribbean nation in the last 20 years.

Local media reported that sporadic rioting had broken

out again in the capital after the speech. Other eyewitnesses reported a tense calm with soldiers and armed personnel carriers patrolling the streets. Barbados president Ivan Bustos, president from 1982 to 1978, is now leader of the opposition rightist reformist party. Sr Blanco stressed he would remain in office for his full four-year term, ending in August 1986, and praised the security forces.

Some 7,000 troops and police have been deployed in the streets of the capital, using the city's main football stadium as their headquarters, witnesses reported. They said prisoners were being held in army barracks because the jails were full. Reuters

Barbados had a head start, according to Government officials, in approaching the Fund when the first signs of trouble appeared. But certainly for the Dominican Republic, and perhaps for Jamaica and Guyana, too, it may be just a bit too late.

ber, and an agreement with the IMF to cut the budget deficit from 15 per cent of GDP to a single digit figure at one go, are seen to be unpopular. Jamaica's parallel exchange rate was done away with and the currency unified in November, to pave the way for negotiations with the IMF.

While he contemplates the travails of President Blanco, Mr Seaga must recall that it was the implementation of the IMF conditions in the late 1970s which eroded the popularity of Mr Michael Manley, his predecessor, forcing a general election which brought Mr Seaga the Prime Ministership.

As in the Dominican Republic, too, Jamaica's creditor banks have agreed in principle to reschedule a part of the foreign debt, but are keen first on seeing an agreement with the IMF.

In Guyana, President Forbes Burnham is likely to regard the Dominican Republic's problems as vindicating his bold stand against the IMF.

Mr Burnham last year rejected IMF proposals for a substantial devaluation, and a cut in the budget deficit by the removal of subsidies on staples such as rice and sugar.

Mr Burnham indicated some move towards meeting IMF suggestions by devaluing the Guyanese dollar by 20 per cent earlier this year. But while the official rate of exchange is G\$75 to the U.S. dollar, the black market rate is G\$15 to the dollar.

The Government is hoping that international creditors will reschedule payments on the country's US\$1.3bn foreign debt. But the creditors, like those of the Dominican Republic and Jamaica, will want a pact with the IMF first.

Ironically, the disturbances in the Dominican Republic came only a few days after the Government of Barbados publicly boasted of an impressive achievement. The island's economy met the final performance criteria and had completed an IMF programme, agreed in 1982, and qualified for \$35m in credits.

Barbados had a head start, according to Government officials, in approaching the Fund when the first signs of trouble appeared. But certainly for the Dominican Republic, and perhaps for Jamaica and Guyana, too, it may be just a bit too late.

50 LUDGATE HILL EC4

APPROXIMATELY 118,500 sq ft NET OF OFFICES

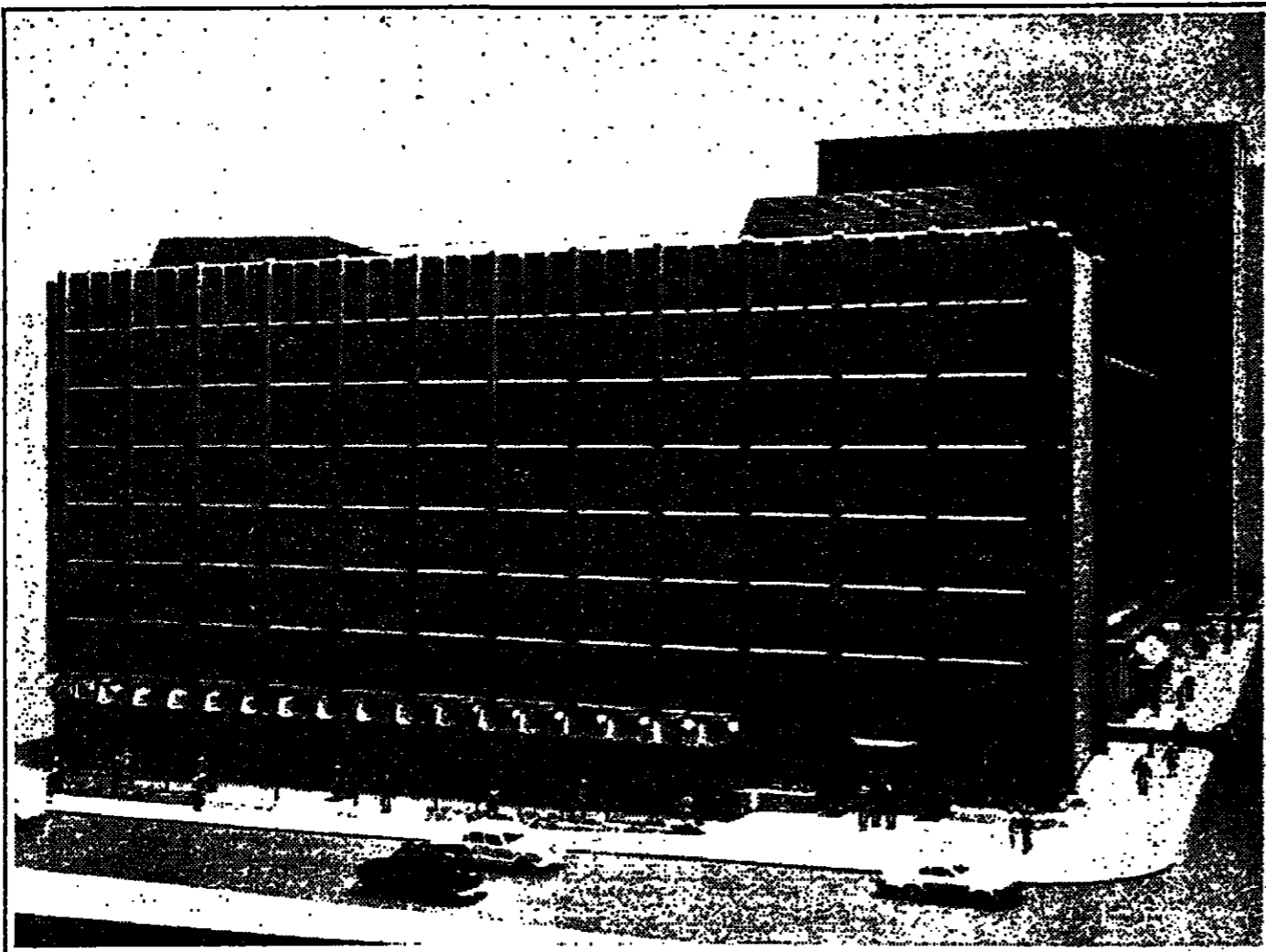

26 OLD BAILEY EC4

APPROXIMATELY 63,500 sq ft NET OF OFFICES

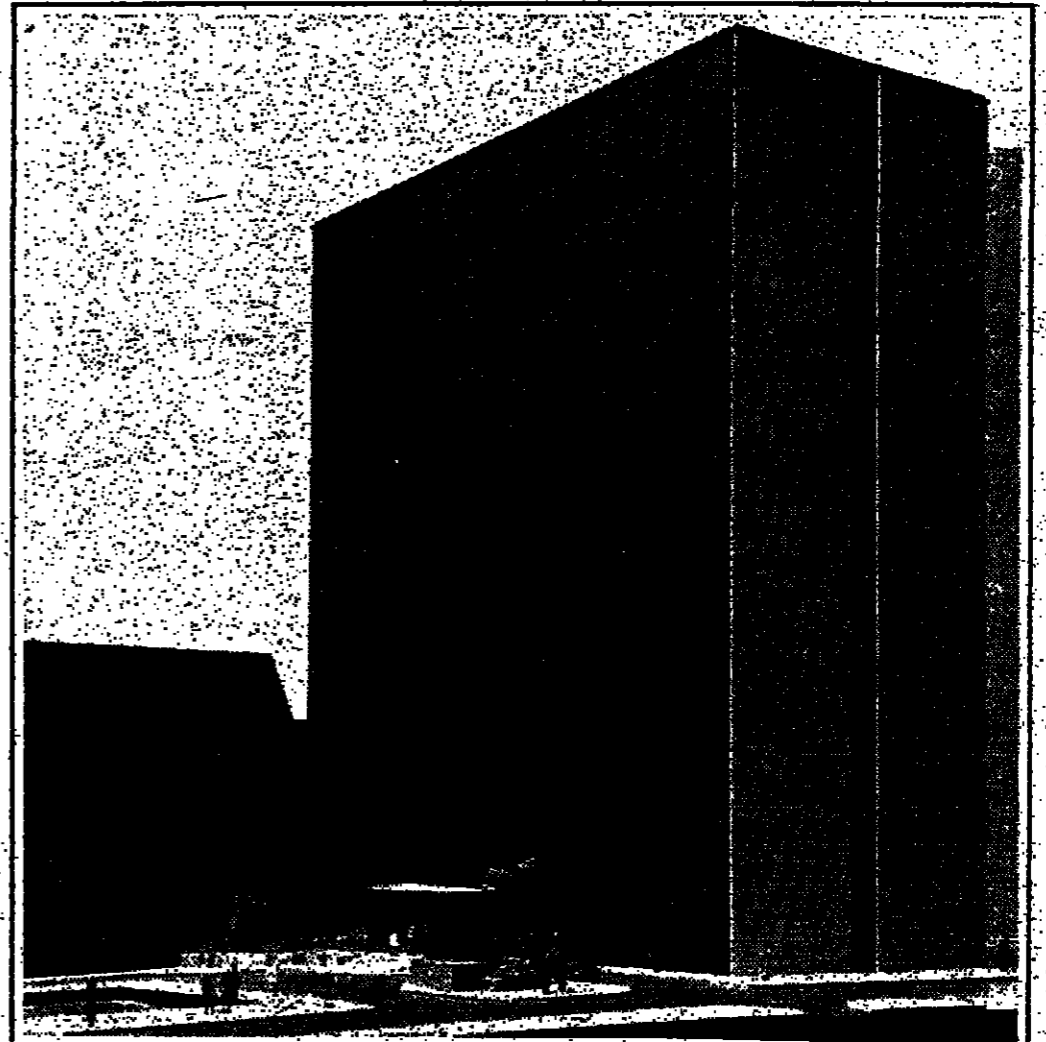

A TOTAL OF 182,000 sq ft TO LET

A development by The City of London Real Property Company Limited

Part of The Land Securities Group

AGENTS

Baker Harris Saunders

01-726 2711

Spillies Ltd

No wonder investors are glued to the box.

```

Prestel CitiService 881951a 5p
FT-SE 100 constituents
Last change at 12:37

o/night latest high low
Globe IT 236
Glaxo Hdgs 847 850 50 50
Grand Met 326 328 28 28
GUS 'A' 655 653 53 53
Hse Fraser 246 258 58 48
Hambro Life 426 428 28 28
Hammersh 'A' 845 840 40 40
Hanson Tr 192 193 93 93

GLAXO INTERIM RESULTS - key 2
de Zoete & Bevan: morning notes - key 3
Unit Trust prices + dealing service - 4
Hoare Govett International Commentary-5
1 Explanation 7 back 9 forward
0 Main sector index
    
```

```

Prestel CitiService 1 8817059a 0p
British Petroleum Share order
closed at 505p on 13-APR-1984

Transaction buy buy/sell/exit
Price limit best or at "best"
How many? complete
or one field
Value £ 5000 only
Confirmed YES password/no=exit
More? NO yes/no=summary
From Gilbert Field
Order placed with Hoare Govett
SAT 14 APR 1984 19:10
0 CitiService index
    
```

```

de Zoete & Bevan 781619a 0p
RESULTS SERVICE 16.15pm 3th April
GLAXO - EXCELLENT INTERIM FIGURES
■ Pretax profit for first half 1983/84
announced £117.4m (£90.4m) close to the
top end of expectations (de Z&B est.
£118m).

■ Features of first half 83/84 trading
include a) sales volume gains of 23% on
a comparable basis. b) Sharply improved
margins. c) Excellent progress from
Zanfac in both the US & Europe &
d) further advances from other drugs,
notably Ventolin & Zinacet.

■ We continue to expect £260m pretax
for 83/4.

RECOMMENDATION: STRONG BUY
1 Financial stats 2 S/E Prices
3 Four year chart 4 Latest news
5 Co. announcements 6 %/£ rates
    
```

```

Prestel CitiService 881952a 15p
Spot Gold: London close
Yesterday's H 382.00
L 380.50
C 380.50
New York C 378.40

+ ..... F ..... F ..... + F=Fix
PCIs 9 10 1 2 1 2 3 4 5 C

1 Latest price 5p 4 New York Comex
2 London Gold Futures 5 £/$ chart
3 Commodity index 6 Forward rates
    
```

All over the country people are putting down their telephones, picking up their Prestel CitiService keyboards and switching on their TV sets.

It's a revolution. Suddenly private investors and their advisors are as in touch with the markets as the most sophisticated of brokers, and on an equal footing with the big institutions in obtaining the latest news and recommendations.

Real time prices. Prestel CitiService offers real time prices (prices continually updated) so that subscribers know what is happening, when it is happening, and can make better, more profitable decisions.

During business hours prices include all those on the London Stock Exchange and the USM (transmitted direct from the official Stock Exchange Computer), spot and forward rates on the foreign exchanges, company announcements and city news.

Plus the latest London and US commodity prices, financial futures, the FT30, the new FT-SE 100 and the Dow Jones indices.

You can even see tomorrow's unit trust prices today.

Electronic share ordering. And if investors are private clients of leading brokers, Hoare Govett, they will even be able to place 'buy' and 'sell' orders seven days a week, 24 hours a day.

It's the future and it's here now. It means investors can study the market, receiving confidential information and recommendations from Hoare Govett and other brokers, and make their decisions when they have the time and the inclination, like evenings and weekends.

Orders sent to Hoare Govett will be processed as soon as trading starts. Other brokers will offer this service shortly.

An affordable service. Your existing TV set or personal computer can be adapted to receive Prestel CitiService or we can supply a new Sony desktop business terminal for rental or purchase.

(Some brokers now think CitiService so valuable they are supplying the equipment free to clients. Ask yours.)

The charge is from only £5 a quarter and only pennies each time you retrieve the information you want. You view prices and information only when you want to, and you pay only for what you use. Just like the telephone service.

For 7 day, 24 hour investing. Once connected, it is simplicity itself to call up the prices and information using the hand-sized keyboard. You can even send messages to other Prestel users or anyone with a telex machine.

Now think again what this all means: at any time of the day or night, and even on weekends, you can view markets, see what your broker thinks, make decisions and communicate with your broker. He will get your message or query the minute his office opens. No more missed opportunities!

The Stock Exchange wants to see a much wider spread of share ownership in this country. The availability of price information on Prestel CitiService is an important step in this direction, comments Sir Nicholas Goodison, Chairman of The Stock Exchange.

Act now. Find out more, right now, by telephoning Adrian Dear on (04862) 27431 or by sending the coupon.

Send to: Prestel CitiService, Woodsted House, 72 Chertsey Road, Woking, Surrey GU21 5BJ.

Name _____
Address _____

Tel: Day _____ Eve. _____



PRESTEL, CITISERVICE IS A JOINT VENTURE BETWEEN ICV INFORMATION SYSTEMS LIMITED AND BRITISH TELECOMMUNICATIONS.

WORLD TRADE NEWS

Mexico set to give go-ahead to finish \$2.8bn steel complex

THE MEXICAN Government is shortly expected to give the go-ahead for completion of a \$2.8bn (£2bn) steel complex on the Pacific coast...

Port strike hits India's engineering exports

For the first time in a decade, India's engineering goods exports have declined for 1973-84 to Rs 12.5bn (\$810m) from the previous year's slightly higher figure...

Canada expands its Third World exports

BY BERNARD SIMON IN TORONTO

CANADA'S OUTGOING Prime Minister Mr Pierre Trudeau has had scant success in his crusade to stop the nuclear arms race...

Lalonde, the Finance Minister, promised to earmark up to half of future increases in foreign aid to an "aid-trade fund" with the aim of bolstering Canadian companies' participation in the Government's aid programme...

Details of the fund, which may reach C\$1.3bn by 1990, are being worked out by the authorities and local business groups. In the meantime, conditions of a mixed credit programme, which blends aid and trade financing, have been related to improve the competitiveness of Canadian exports...

Pierre Trudeau's foreign policy initiative to expand links between rich and poor countries appears to be bearing some fruit—at least for Canadian exporters.

Exports to Sri Lanka have more than trebled, to Ghana more than doubled, and to China, new Canada's fifth biggest foreign market, rocketed by 31 per cent.

China books satellite launches on Ariane

BY DAVID MARSH IN PARIS

CHINA HAS confirmed its growing interest in European space collaboration by booking reservations to launch two television satellites using the Ariane rocket in 1987 and 1988.

China's TV broadcasting satellite programme has been slower to get off the ground than many European industrialists had hoped.

France-German consortium which would also include Aerospace of France, is hoping for a decision soon on orders for two Chinese TV and radio satellites which could be worth a total of \$50m (£38m).

by many interested European companies at a meeting in Stresa, Italy, next week.

French likely to win Tunisian plant order

BY FRANCIS GHILES

THE FRENCH consortium of Spie Batignolles and Heurtey Industries is expected to win the Tunisian Dinar 49m (\$45.5m) contract to build a phosphate plant at I Shkira, on Tunisia's south-east coast.

Tunisian authorities are worried about the revaluation of the Yen which could, over the medium term, push up the overall cost of the plant to the buyer.

contract to build a dam in Siliama in central Tunisia, more than half the cost of which is being financed by the Kuwaiti Fund for Arab Economic Development.

The meeting is being sponsored by the EEC and the Arab Space Agency, and is supported by Aerospatiale, British Aerospace, and Messerschmitt-Bölkow-Blöhm, and other members of Euro-space.

UK bid to have Spanish motor tariffs removed

BY LORNE BARLING

BRITISH MOTOR components manufacturers have launched a major initiative to encourage the removal of tariff barriers imposed by Spain to protect its motor industry from foreign competition.

to 15,000 cars to be imported at lower tariffs.

BASE LENDING RATES table listing various banks and their interest rates for different terms and currencies.

Smith New Court Limited advertisement featuring the company name, logo, and text: 'Experience & Strength - essential for dealing in international markets'. Includes contact information for London, Los Angeles, Melbourne, New York, Singapore, Sydney and Zürich.

Fly the Golden Falcon Direct to Doha Daily. Advertisement for Gulf Air featuring a large image of a golden falcon and text: 'Gulf Air has seven Golden Falcon TriStar departures a week to Doha. You'll enjoy the warmest possible welcome...' Includes the Gulf Air logo and Arabic text.



**"I've got a
problem with
my computer
system."**

**"It'll be fixed
in a matter of
minutes, sir."**

Yes. Even a Honeywell computer can have problems. But our computers can do something most others can't.

Mend themselves over the phone.

As you know, Honeywell computers can talk to each other. And that's what they do when one develops a fault.

Your computer tells ours what's wrong.

If it's a software fault, we can install a software "patch" over the telephone.

And our computer's diagnosis of a hardware fault can save you hours in down-time.

If you haven't got a Honeywell you could have a problem. So why not give us a ring on 01-568 9191 and ask for extension 2471.

We can talk about the Honeywell servicing system, which is founded on the most fundamental equation **Together, we can find the answers.**
in business.

Time = Money.

Honeywell

Honeywell Information Systems Ltd, Great West Rd, Brentford TW9 5EH.

UK NEWS

Ministers rule out check for Libyan weapons

BY JOHN HUNT

THE GOVERNMENT intends to allow the Libyans to take their guns and explosives with them concealed in their diplomatic bags when they depart from the People's Bureau in St James's Square.

Ministers are now reconciled to the fact that there is no effective way in which they can prevent this happening.

That became clear yesterday as preparations were under way for the Libyans, who have been ordered out of Britain, to fly back to Tripoli.

Advice to ministers has been that it would be very difficult to get around the Vienna Convention on diplomatic immunity and demand to examine the contents of the baggage which the Libyans will take with them.

Britain is anxious not to lay itself open to a charge that it is breaching the convention. Such an accusation would be particularly embarrassing after Britain's international initiative to reform the convention on diplomatic immunity.

Nevertheless, the failure to prevent Libyan arms and explosives covertly leaving the country is not going to make the task of the Government any easier when further statements are made to the House of Commons next week.

It was also clear that once the immediate emergency is over, the Government is eager to maintain normal commercial relations with Libya despite the decision to sever diplomatic links with the Gaddafi regime. In the words of one Cabinet Minister: "An awful lot of damage limitation" will be necessary on relations between London and Tripoli.

There are fears that if the British commercial presence was reduced the gap would be filled by Italy, France, Japan and even America, which has stringent controls on its exports to Libya.

British trade is seen as important by the Government although it is not large compared with our exports to other states. Last year the UK exported goods worth £274m to Libya, a 5 per cent increase on the previous year. This mainly consisted of machinery, transport equipment and chemicals.

Imports from Libya, mostly oil, were worth £224m, a drop of 34 per cent.

Minet counts cost of alleged fraud

BY JOHN MOORE, CITY CORRESPONDENT

MINET HOLDINGS, one of the largest British insurance brokers, with extensive Lloyd's of London insurance interests, was yesterday counting the cost of the alleged misappropriation of £38.9m (\$55.2m) from Lloyd's insurance syndicates under the group's management.

Announcing pre-tax profits for the financial year ending December 31, 1983 of £20.4m, compared with £17.8m a year earlier, the group has disclosed extensive provisions to support the operations of its underwriting agency PCW Underwriting, renamed Richard Beckett Underwriting Agencies. A total provision of £8.7m has had to be made since the troubles arose in the group at the end of 1982.

During 1982, auditors Deloitte Haskins & Sells, carrying out an audit into the affairs of UK insurance brokers Alexander Howden for Alexander & Alexander Services of the U.S., which had taken over Alexander Howden, discovered that not only had money been misappropriated from Howden funds but that agency companies at Minet might also be involved in similar troubles.

The auditors established that \$55m had been misappropriated from insurance interests of Howden, another large Lloyd's broker, and that other money had been diverted out of Minet and channelled offshore through a number of Howden companies to various private interests controlled by Minet executives.

It transpired that as much as £38.9m had been channelled out of funds belonging to over 1,400 members of the Lloyd's syndicates under the management of the PCW Underwriting agencies.

A letter to the Lloyd's underwriting members sent yesterday by Mr Richard Beckett, chairman, said investigations had revealed that "some aspects of the syndicates (to which the Lloyd's members are grouped) were conducted in an irregular manner."

Mr Beckett says that money was placed offshore with over 150 companies or trusts in at least seven different countries in the form of "reinsurance" contracts for the syndicates which allowed the directors of the PCW Underwriting and an associate agency company, WMD, to receive "improper personal benefit."

Those primarily responsible for effecting those reinsurances, he

said, were "Mr Peter Dixon and Mr Peter Cameron-Webb. They were also in a position to control the ultimate reinsurances and the funds paid for those reinsurances. They appropriated secretly funds from various of the companies and trusts and used them for their own benefit. They also diverted funds to other former directors of PCW, Mr Adrian Hardman, Mr John Wallrock, former chairman of Minet, and Mr Anthony Oldsworth to Mr Colin Davies, a former director of WMD, Mr Barry Newman, a business associate of Mr Dixon, and Mr Alan Sampson, a director of PCW's service company."

Mr David Hill, another former director of PCW, received, Mr Beckett said, "a smaller sum of money from the same source." He said civil proceedings had been initiated against all the named individuals who are defending the actions. Mr Hill and Mr Hardman are suing Richard Beckett Underwriting for wrongful dismissal.

Between 1970 and 1978, the funds were channelled in the form of reinsurance to a company set up in Guernsey, Regal Excess. Regal in turn passed the money over in the form of reinsurances into one, or in some cases two, other companies set up in the Isle of Man, one of which was also called Regal Excess, which reinsured part of the Minet's Lloyd's syndicates directly during 1977. In 1979, the bulk of the funds remaining in the Isle of Man were transferred to companies in Gibraltar.

Between 1978 and 1980, reinsurances were arranged through Alexander Howden Insurance Brokers and the money channelled out of the syndicates in the form of premiums ended up, through a range of routes, in settlements and companies mainly administered from Switzerland. In October 1982, large cash sums and assets were transferred from Switzerland and transferred to Gibraltar.

Between 1978 and 1980, reinsurances were arranged for the syndicates through the Howden broking company and the premiums ended up in companies owned by other settlements in Gibraltar.

Some of the funds, it is understood, were used to invest in a race horse syndicate in the U.S., oil well developments, and film production interests.

The hunt for the missing money continues.

Mineworkers 'optimistic' on talks

BY JOHN LLOYD, INDUSTRIAL EDITOR

THE GOVERNMENT may be brought in to talks on the future of the coal industry if the National Coal Board, the National Union of Mineworkers and the other mining unions can agree an agenda for a tripartite meeting.

Mr Peter Heathfield, the NUM's general secretary, discussed such a meeting during a telephone call yesterday with Mr Ned Smith, the NCB's director for industrial relations. Mr Heathfield said last night: "I am hoping we will be able to arrange a tripartite meeting. I am an optimist by nature."

Contact between the three mining unions and the NCB has continued since the March 6 consultative council meeting at which Mr Ian MacGregor, the NCB chairman,

presented his proposals to cut 4m tonnes of capacity with the loss of 20,000 jobs.

In spite of the NUM's violent opposition to those proposals, it was agreed that the unions and the NCB should continue a search for a common agenda on which they could approach the Government.

Mr Peter Walker, the Energy Secretary, has already indicated that he would be prepared to meet the NCB and the union if they could first agree a joint approach.

However, talks on the seven-week-old dispute between the union and the NCB are unlikely in the short term. Mr Heathfield reiterated the union's opposition to any contraction or redundancies to Mr

Smith, and the NCB said later that this ruled out a meeting in the short term.

Mr Heathfield, however, while stressing that "it is unlikely we will be sitting round a table talking about closures," added that "if the board were to modify its approach, we could talk about expansion in the future."

The NUM's continuing failure to convince the Nottinghamshire and other Midlands miners to support the strike was demonstrated again yesterday when the NCB reported that 52 pits were producing coal - 46 "normally" and six more, less coal than usual.

It was the best production position since the miners' strike began. The NCB said that 87 per cent of

the Nottinghamshire mineworkers were working normally, with many of the rest taking extra days off, or sick.

Mr Arthur Scargill, the NUM president, who is deeply concerned over the Nottinghamshire position, said yesterday that the NUM would stage "a national demonstration" in Nottinghamshire, although no date or venue has yet been fixed.

Speaking after addressing a rally in Blyth, Northumberland, attended by over 2,000 miners, he said: "We will be looking to the whole of the trade union movement to join us to demonstrate to the British people the justice of our cause."

Mr Scargill said he would ask the TUC to make a 50p levy each week on all trade unionists

Labour to press for VAT relief

THE LABOUR Party will next week seek to remove the proposals to impose value added tax (VAT) on hot takeaway foods and on building repairs and improvements, when the House of Commons debates the Finance Bill.

It will focus its attack on the proposed extension of the scope of VAT, and also on the alleged unfairness of a change in treatment of bank interest, and on the failure to change the age allowance in line with other personal income tax reliefs.

Among its proposals are that VAT should not apply to hot food supplied from mobile premises or items packaged separately. An exemption will also be sought on food supplied for home delivery.

A number of Conservative MPs have also tabled amendments which seek to ease the impact of the extension of VAT to building repairs.

MORE THAN 130 Labour MPs have signed a House of Commons motion criticising Mrs Margaret Thatcher, the Prime Minister, over the Oman University affair. They seek "a clear and unequivocal answer" to the question of whether she knew of her son, Mark's, interest in securing an Oman University contract for Cementation International - for which he was a consultant - during a visit she made to that country.

BRITISH OIL companies will increasingly look outside the UK, to areas with more stable and less onerous tax regimes, for exploration and development opportunities, a leading British independent oil company said. Mr Geoffrey Searle, chairman of Lomo, said that his own company would be drilling more than 200 wells this year, of which over 80 per cent would be outside the UK.

SPENDING by overseas visitors to the UK in February rose to £200m, an increase of 28 per cent on the same month last year, according to Department of Trade and Industry figures.

In the same month spending abroad by UK visitors totalled £176m, giving a surplus of £24m in the UK-foreign travel account for the month, compared with a deficit of £21m a year earlier.

HOLIDAY INN, the world's largest hotels group, is to open its sixth London hotel. It has bought the leasehold interest of the 192-room Hotel Bristol in Mayfair from Trafalgar House in a deal worth £5m. The hotel will be renamed Holiday Inn Mayfair after a £1m refurbishment.

NEW ORDERS gained by engineering industries rose by 8.5 per cent in the three months to January. The increases are derived from rises of 7.5 per cent in new orders from the home market and 10.5 per cent in new orders from export markets.

MR BRIAN COURTENAY, chief executive of the Trimoco group, is to be next president of the Motor Agents Association.

Soviet cruise ship cuts not sufficient, say UK operators

BY ANDREW TAYLOR, SHIPPING CORRESPONDENT

VERBAL SALVOES exchanged between UK and Soviet cruise ship operators continued yesterday when Russian-owned CTC Lines proposed cuts in 1985 capacity that P & O Cruises and Cunard felt did not go far enough.

CTC said some 186,000 bednights - nights multiplied by berth numbers - would be offered in the UK market next year, a drop of 6.75 per cent. This follows a 28 per cent reduction in 1984 capacity from just over 250,000 to 179,300 bednights.

The cuts are a result of steady pressure from the two large British cruise ship companies, mostly from P & O and Cunard, to lower what they regard as excess capacity being offered at virtual dumping prices.

CTC, however, has argued that a

large proportion of its passengers join its ships on the Continent. Yesterday, it said the dispute with the UK operators "failed to take account of the interest of the consumer."

Directors of both UK companies rejected this, claiming that a sizeable number of CTC vessels' berths went unfilled. Dr Rodney Leach, chairman of P & O Cruises, also criticised CTC for making its statement in the middle of continuing negotiations.

These followed a meeting in Leamington in February between British executives and officials, headed by Dr Leach, and Russian representatives, including those of Morpashof, which owns CTC Lines. Dr Leach called the CTC state-

ment issued in London, "a unilateral breach of continuing negotiations." A reduction of only 6.75 per cent, he said, would still leave CTC's capacity well above the 1978 level of 116,400 bednights.

The market for UK cruise passengers is worth some £100m a year in total fares - mostly for voyages from UK ports, but also including fly-cruises in which people are flown to ships in foreign ports - and has recently been static.

Last year, according to the Passenger Shipping Association, more than 47,000 UK residents cruised from British ports, with just over 50,000 forecast for 1985. This is well down on the 1981 level due to recession and the disruption caused by the Falklands war.

'No breach' over Observer row

BY KEVIN BROWN

MR NORMAN TEBBIT, the Trade and Industry Secretary, yesterday refused to intervene in the dispute between the editor and proprietor of the Observer newspaper.

Mr Tebbit told the House of Commons that no government "conditions" over editorial independence had been breached by the reaction of Mr Roland "Tiny" Rowland, chairman of Lorrain, which owns the paper, to a story by Mr Donald Treford, the editor, on alleged atrocities in Zimbabwe.

Mr Tebbit said "conditions safeguarding editorial freedom" were attached to the sale of the Observer to Lorrain in 1981. But these were a private agreement between Lorrain, Mr Treford, the National Union of Journalists, and Outram Limited, the former owner of the paper.

Mr Tebbit said the editorial safeguards written into the agreement

had to be enforced by the five independent directors appointed at the time of the sale to police them.

Mr Tebbit said the Government would become involved in the dispute only if an application was made for consent for a transfer of ownership of the paper, which would require a reference to the Monopolies Commission.

In reference to talks with Mr Rowland and Mr Robert Maxwell, head of British Printing and Communications Corporation, over a possible takeover of the Observer, Mr Tebbit said no application had so far been made.

But while insisting that there were no grounds for government intervention, Mr Tebbit quoted a guarantee given by Mr Rowland to the Monopolies Commission that editorial independence on the Ob-

server would be guaranteed "whatever the cost" to his other business operations.

He told Labour MPs: "You must not confuse the issue as to whether or not I take these matters seriously with the question of what powers I have as Secretary of State to act."

Mr Peter Shore, Labour's trade spokesman, accused Mr Rowland of displaying "the insolence of wealth and the arrogance of power."

Threats to close the paper, to sell it or to withdraw advertising were "a deliberate and massive attempt to further coerce the editor and deny him the same expression of opinion."

Mr Shore claimed the editor's independence had been guaranteed at the time of the Lorrain takeover by Mr Tebbit's predecessor, Mr John Biffin.

Exporters seek subsidies assurance

BY CHRISTIAN TYLER, WORLD TRADE EDITOR

BRITISH EXPORTERS yesterday demanded a "clear statement" from the Government that it would continue to support the sale of capital goods overseas.

They protested that a recently-released report by senior Whitehall economists questioning the value of export subsidies had created "uncertainty and consternation" about the Government's commitment.

Executives from the UK's leading process plant and power engineering companies claimed that the report, which had been circulating in Whitehall for more than a year, had led to the denial of aid and consequent loss of key contracts.

The report was produced by economists from the Treasury, the Departments of Trade and Industry and the Overseas Development Authority, led by Mr Ian Byatt, the Treasury's deputy chief economic adviser.

It concluded that there was little economic justification for subsidising export credit interest rates, or

using aid to match competing countries' soft loans to Third World buyers.

Yesterday the National Economic Development Office published what it claimed was a detailed rebuttal of the Byatt analysis, on behalf of the heavy electrical machinery and process plant "little Neddies," it charged the Whitehall economists with faulty analysis and ignorance of the industry and of "normal commercial practice in the international market."

Sir Campbell Fraser, president of the Confederation of British Industry (CBI), asked the Chancellor of the Exchequer to reassure exporters that publication of the Byatt report did not mean a change of government policy.

Demanding that government support be not only maintained but improved, he said that unilateral disarmament by Britain "in the face of international competition" would have a severe impact on overseas business.

Mr John Lippitt, a director of GEC, said he deplored the fact that industry had not been consulted.

He denied that export subsidies benefited only a few major companies, or the foreign buyer at the British economy's expense. "Contracts are carried out by many hundreds or thousands of subcontractors," he said.

Britain's project-related aid budget of around £50m a year - also criticised by the Byatt report - should be raised to £100m by diverting funds from the bilateral aid budget, he said.

The NEDO study said the average rate of export credit subsidy for capital goods had fallen to 2.25 per cent, because of the latest agreement within the OECD. This was a quarter of the figure quoted by Byatt at the end of 1982.

Official support for large overseas projects: NEDO, Millbank Tower, SW1P 4QX
Editorial comment, Page 18

ONCE AGAIN NOTED

GLASGOW
Albany Hotel
PETER OMFARA
041-248 2636

EDINBURGH
Post House Hotel
PETER HILL
01-348821

HARROGATE
Majestic Hotel
FRANK FLAHERTY
(0423) 68972

LEEDS
Post House Hotel
STEPHEN BROOM
(0532) 84291

SHEFFIELD
Grosvenor House Hotel
ALFREDO CIARELLI
(0742) 20041

SWANSEA
Dragon Hotel
MICHAEL DOLANORE
(0792) 5101

MANCHESTER
Post House Hotel
CHAIG DRUMMOND
061-998 7090

CAMBRIDGE
Post House Hotel
PAUL BONNETT
(0223) 7000

LANCASTER
Post House Hotel
DAVID COOKE
(0524) 65999

NOTTINGHAM
Albany Hotel
RAYMOND KEEN
(0602) 470131

BIRMINGHAM
Post House Hotel
VINCENT BOWDITCH
021-357 7444

COVENTRY
Post House Hotel
JOHN MILLER
(0203) 402151

YORK
Post House Hotel
RACHEL CARRUTHERS
(0904) 707921

LONDON
Grosvenor House
PETER EYSSENS
01-499 6363

هنا صد اقول

Pym book likely to embarrass Thatcher

By Peter Riddell, Political Editor MR FRANCIS PYM, the former Foreign Secretary, is to set out his views on Britain's domestic and international problems in a book to be published in two months' time.



Mr Francis Pym: Warning on divisive policies

Government over its local government proposals. In the introduction to the book, Mr Pym says he hopes it will be regarded "as a constructive and forward-looking contribution to political debate."

Guernsey woos light industry

BY TIM DICKSON THE TINY island of Guernsey - best known for tourists, tomatoes and tax exiles - is actively promoting itself as a site for new light industry.

Balancing capacity with demand 'still British Steel's main problem' says MPs' report Doubts linger over Ravenscraig's future

THE ALREADY tenuous prospects of British Steel Corporation's (BSC) Ravenscraig steelworks in central Scotland look much weaker in the light of evidence published by the House of Commons trade and industry committee yesterday, even though the committee itself recommends that no steel works are closed.

Table with 4 columns: Quality performance of major suppliers to the Ford Motor Company's plant at Halewood, Liverpool, January to October 1983. Columns include Tonnes received, Tonnes rejected, and %.

This has to be balanced in the discussion on the outlook for steel demand and the capacity BSC will need to satisfy it. The Government rejected BSC's request in 1982 to close Ravenscraig on the grounds that the corporation's demand forecasts were too pessimistic.

It was also felt that BSC should not cut any more capacity until other European Community countries made further progress in fulfilling their commitments on this front. On privatisation, the committee was sceptical about the merits of the proposed merger of the engineering steels businesses of BSC and GKN.

Industrial managers 'lose ground' on pay

BY ANTON LA GUARDIA BRITAIN'S MANAGERS, particularly those in traditional manufacturing industries, are not benefiting from the economic recovery as much as other workers.

fuel benefit taxation and increases in personal tax for company car users, the survey showed a record number of managers receiving company cars. According to the figures, 98 per cent of directors and 63 per cent of managers have a company car.

Ireland's security braves a changeable climate

CONSTABLE John Robinson of the Royal Ulster Constabulary fired 19 shots at two members of the Irish National Liberation Army, reloading in the process, and killed them both. They were unarmed, and their car was stationary with the handbrake on.

GROUP IN BRITAIN.

We've just been voted Best Hotel Group in Britain* Again. And we're rather proud of it. Whatever your reasons for choosing us, you can be certain that our managers and staff will never forget they are there to look after your every need.

LONDON Westbury Hotel VICTOR HUBER 01-629 7755

GATWICK Post House Hotel JOHN DELANEY (02934) 71621

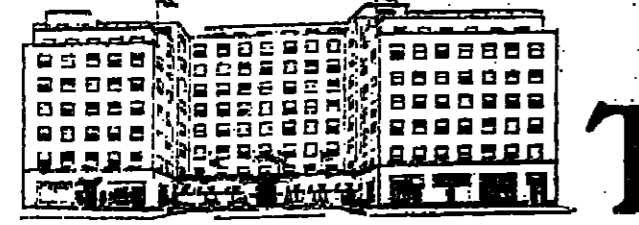

Yours faithfully Trusthouse Forte



HEATHROW Excelsior Hotel BRIAN MURPHY 01-759 6601

STILL STREETS AHEAD. Advertisement for hotels including EXMOUTH, SOUTHAMPTON, SHERBORNE, LONDON, OXFORD, LONDON, CHELTENHAM, and HEATHROW.

On the benefits of flying with an airline that offers you a choice: First Class, Business Class and Economy Class worldwide.

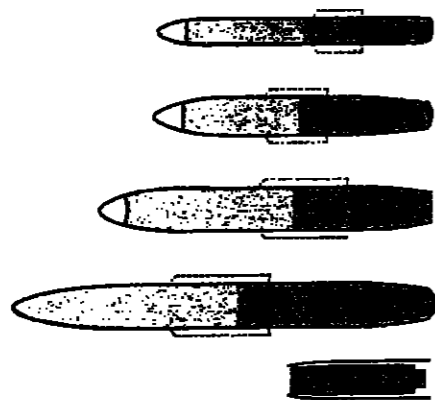

The new distribution of First Class, Business Class, and Economy Class seats on Swissair aircraft:
 DC-9-81: 12/25-79/38-92.
 Airbus A310: 16/40-115/73-148.
 DC-10-30: 22/57-63/136.
 Boeing 747-357: 36/63/276.
 Boeing 747-357 Combi: 24/57/195.



With one of these three cards, you can go aboard and take your seat:
 Red boarding card, First Class.
 Blue boarding card, Business Class.
 Green boarding card, Economy Class.



The Swissair route network includes some 100 destinations all over the world: 47 in Europe, 13 in the Near and Middle East, 10 in the Far East, 21 in Africa, 4 in South America, and 5 in North America.

Once again Swissair has renovated its fleet but not all the recent improvements are obvious from the outside. For now on all Swissair aircraft we offer you a choice of 3 classes instead of the previous 2. This means you can select exactly the standard you require to fit your personal travel requirements throughout the entire Swissair network. To 100 destinations worldwide.



First Class,
 Business Class,
 Economy Class
 worldwide on all
 aircraft.

هذا صناعي

THE MANAGEMENT PAGE

EDITED BY CHRISTOPHER LORENZ

Why it gets harder to stay ahead

Nick Garnett reports on a Mather and Platt division's quest to sustain quality

"THERE ARE two types of quality," says Tony Wright. "There's that of the high quality car but where at the end of the day you can call out a repair service if it should break down. Then there's the kind of quality we have to meet. If one of our pumps stops working in the middle of the North Sea the Automobile Association just won't want to know about it."



Third in an occasional series

As managing director of Mather and Platt's rotating machinery division, which employs 1,200 in Manchester making pumps, electric motors and pumping sets costing up to £500,000 and more, Wright works in an environment in which companies do not survive unless they have stringent control, but where quality is still a selling factor among the big pump manufacturers.

Mather has secured in the past three months three separate orders among others involving 18 pumps for India, Holland and the North Sea and for each of which the company did not offer the lowest tender. For one—Mazon Dock, the Indian state platform constructor—the rotating machinery division's was only third lowest. And it says that for all of these orders quality was a crucial element.

Like many British engineering operations, the rotating machinery division—which makes a healthy though undisclosed profit—has never had any real quality problem. It is faced, though, with a series of factors which require it to meet ever-rising quality demands.

Competition never ceases from companies like Hitachi and Ebara, Bingham, Ingersoll Rand and Weir for orders from the oil industry to which the division sells 60 per cent of its products.

Additionally, companies to which the division supplies are requiring Mather and Platt to produce, faster than ever before, pieces of equipment

machined to very fine tolerances. In one case the specification demanded that the vibration level of a pump shaft, spinning at 6,000 rpm, must be no more than one-quarter of a thousandth of an inch.

A subsidiary of the Australian Wesalid Group, Mather and Platt has demonstrated how two things—the introduction of computer aided design (CAD) and simple closer scrutiny of how it uses machines—can improve a manufacturing system in which quality was already a by-word.

One of the areas in which computer aided design has been strikingly successful is in improving stress analysis. An example is the base plate upon which the whole pumping set rests. Before CAD, the division employed some fairly simple rules to determine the stress characteristics of base plates used for pumping sets on oil rigs and platforms. If problems developed during a pump's operation it was not always possible to know for certain whether they were the product of metal fatigue or stress.

CAD allows the company to work to absolute limits. The base plate is divided up on the computer into its separate physical elements, each of whose stiffness characteristics are known. The computer can then apply



Tony Wright has turned to computer aided design to help improve a manufacturing system in which quality is already a by-word

varying loads to different points and at different angles, the varying degrees of stress appearing as different colours on the display unit.

This has permitted much more sophisticated stress testing while at the same time reducing the man-hours involved in doing it. This has played its part in reducing delivery times for a medium-sized pump from up to a year to about a half of that.

Computer aided design is also a valuable tool for resolving engineering problems that have already emerged in a finished product. The division had a particular difficulty with one model of pump in which a balance piston had a tendency to seize.

Only by using CAD were Mather and Platt's engineers able to see what was going on and to completely resolve the problem in a much shorter time than would otherwise have been possible. In this case the pump's end cover plate was fractionally bowing outwards under stress, causing a pinching effect interfering with the piston's movement. "classical

structural mechanics couldn't predict this," says Mike Holt, the division's engineering systems manager.

On the shopfloor there has been no dramatic upheaval on quality improvement but there have been some small changes. One of these concerns the welding of a pump's barrel assembly. At one time a welder used to carry out his task by welding from different angles on a stationary barrel assembly. An in-house designed "manipulator" now rotates the barrel so the welder can stand vertical at all times and weld downwards—the position of optimum control on a welding tool to enhance weld quality.

But for this division of Mather and Platt improving manufacturing performance will be much more closely tied to the use of computers, the next step of which is to link its CAD facility directly to its computer numerically controlled machines. Two local universities are now working with the company on this project.

Previous articles in this series appeared on March 12 and April 13.

Leadership

A quality seeking definition

BY MICHAEL DIXON

"IN SOCIALIST China," said a big poster in London some time ago, "the workers take the lead." Scrawled below was: "In capitalist Britain they don't stop at the lead. They also take the copper, zinc, iron and the fillings out of your teeth."

It may be by chance that the English language uses the spelling "lead" to stand equally for "acting as the masterpiece of progress" and for a poisonous commodity that weighs you down. But the coincidence typifies the British attitude to being organised.

With exceptions such as the military and police, we resist it. Yet that does not stop us, given a reverse in our collective fortunes, from blaming it on lack of leadership higher up—which poses a problem for managers.

Their reaction when their juniors hesitate, if not refuse, to follow them is evidently to take the blame on themselves for their own shortcomings as leaders. For few topics attract more interest from managers as a group than the question of how to acquire good leadership qualities. The trouble is that nobody is sure what those qualities really are, despite the existence of more than enough theories of leadership to wallpaper a mental boardroom.

The kind of leadership to which most aspiring executives aspire is the "charismatic" type, first defined by the German sociologist Max Weber who died in 1920. Charismatic—which means "having the gift of grace"—was his name for one of what he thought were three different ways of exercising authority over groups of people. The others are the traditional type, and the bureaucratic.

He claimed that while in practice leadership is never of any single type, one of the three always predominates. The pole position changes with circumstances including prevailing ideas about rights, duties and so on. If the dominant type loses adequate support it is replaced by another. Severe dissatisfaction is particularly likely to let in charismatic leadership.

It is the type which gives the strongest person power to the leader. Sadly, it can have uncomfortable consequences for many of the followers. Weber

defined it as founded on: "A certain quality of an individual personality by which he is set apart from ordinary men and treated as endowed with supernatural, superhuman or at least specifically exceptional powers or qualities. It is a definition which can accommodate the crimes of a Hitler as well as the charity of a Christ.

The bureaucratic option was Weber's favourite. He saw it as the type most suited to technologically advanced societies with economies based on mass production.

He seemed to believe

One version of this approach has been developed by the British psychologist Dr Meredith Belbin, who has tests which he believes identify people with some or other of the full range of attributes, who can then be assembled into leadership teams. The individual elements are of eight main kinds, as follows:

Chairman — able to clarify goals and priorities, motivate colleagues, promote taking of decisions.

Implementer — to organise ideas and plans into practicable courses of action.

...while the abilities needed to lead in all circumstances are too diffuse to be found in one person, they can be combined in a team

bureaucratic could plan scientifically the future course of the organisation concerned and implement the plans by rational, impartial procedures. As the course to be followed was scientifically determined, mere human leaders would take a back seat. Authority would be vested, not in people as people, but in certain clearly defined jobs or "offices". Persons chosen to hold them, strictly on objective merit, would leave behind their self-interest and other foibles and wield the office's power impartially and logically.

Alas real bureaucracies don't work quite like that. The necessary science of forecasting the future, especially in terms of human behaviour, has not emerged. Lacking predictive science and moral impartiality, top bureaucrats might fall back on convenient myths and precedent. Their rule could then operate as only an elaborated form of the traditional, no better guaranteed to cope adequately with marked changes in conditions.

In recent years there has emerged a new variation on the same theme. It is apparently based on the idea that while the abilities needed to lead in all circumstances are too diffuse to be found in just one person, they can be combined in a team of people.

Professor John Adair of Surrey University.

He thinks good leaders learn to balance three different needs: achieving the objective; developing the followers as a team; developing members as individuals. The impossibility of blanking out any one of these without blanking out part of both the others illustrates that unless the leader attends to all three needs continuously it is impossible fully to satisfy any of them.

But the latest variation advocated by Alistair Mant of South Bank Polytechnic seems to deny not only that concern about "people" needs is essential to good leadership but also that it depends on the possession of certain leadership qualities or skills at all. The key, Mant suggests, is the existence of an objective to which the head of the group is committed and which all the followers can share and recognisably contribute to achieving.

The common understanding of what the group operation is for and how the members relate to it serves as a shared moral criterion to regulate how they behave to one another. So the best way anyone can get others to follow is by being concerned above all with ensuring a product or service that is widely seen as of unmistakable value.

While Mant's moral emphasis refutes the historic notion that there exist qualities or skills enabling the people who have them to be followed no matter where they choose to go, his idea is less than original. It was also held, for example, by Henry Ford who wrote: "Business must be run at a profit, else it will die. But when anyone attempts to run a business solely for profit and thinks not at all of the service to the community, then also the business must die for it no longer has a reason for existence."

Or in other words, sooner or later its leadership will go down like a lead balloon. Lately he sent into the contest a team composed entirely of resource investigators. It evidently won hands down.

Another approach, based on the idea that good leadership is produced not so much by qualities which people have by nature as by skills which can be learned, is represented by

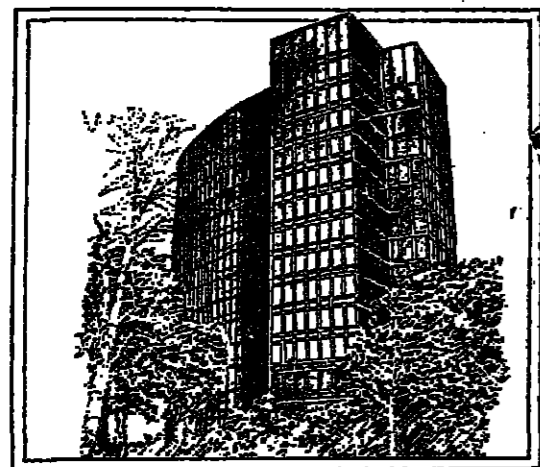

Cost-effective premises

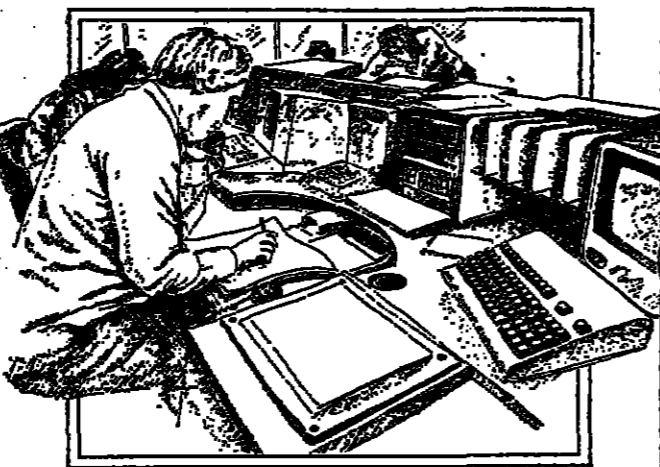

Cost-effective labour

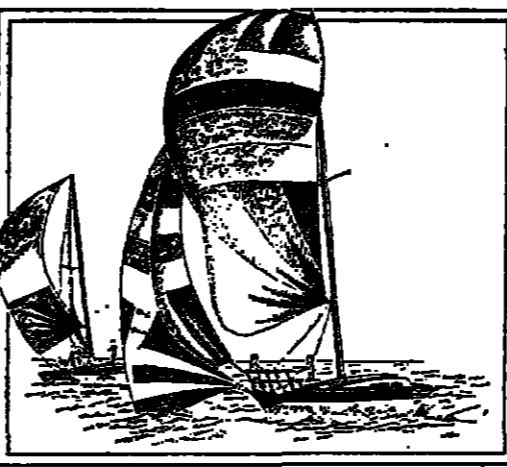

Cost-effective living

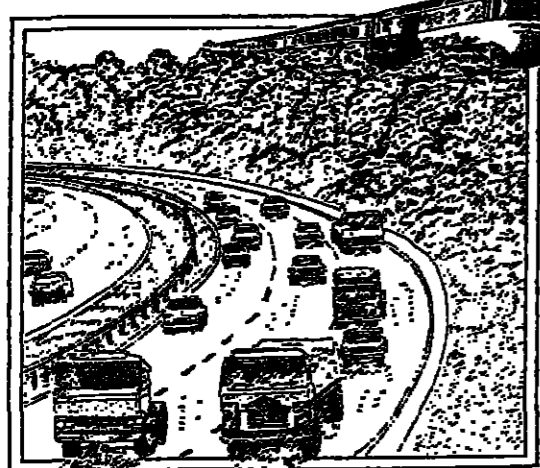

Cost-effective land

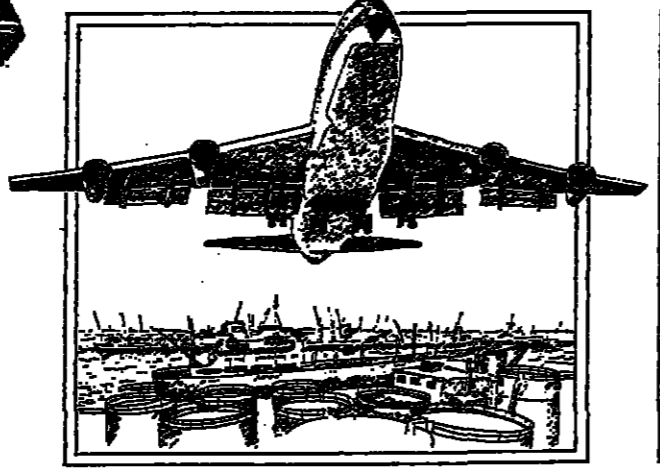

Sea and air communications

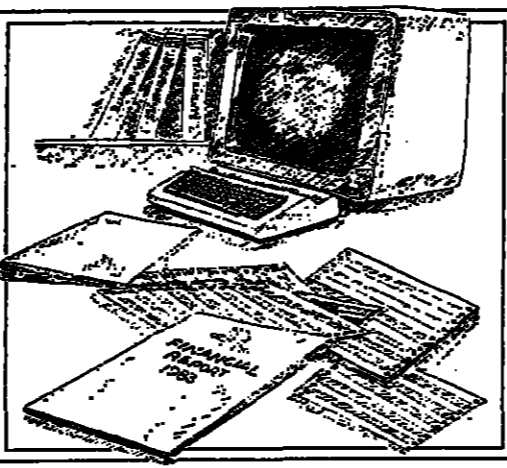

The right climate for profit

Everything about Hampshire adds up to better business.

Any company adviser who's done his homework can confidently recommend Hampshire, England, and its neighbouring Isle of Wight as, potentially, Western Europe's most profitable business location. The reason is simple: in Hampshire doing business is truly cost-effective.

● Cost-effective premises. Modern buildings, ready to move into for a fraction of the cost of similar accommodation in, say, London. Town-centre locations, out-of-town business parks, sites for development.

● Cost-effective manpower. The skills you need backed by good training facilities — in information technology, integrated circuits, optical fibres, frontiers-of-knowledge projects, university research... Already, Hampshire's hi-tech industries employ more than twice the national proportion of the local work-force.



Where people like to work

● Cost-effective environment. The quality of life every family wants — villages, cities, downlands, forests, coast and sea, providing excellent recreation and top value living — including housing.

● Cost-effective communication. Excellent land, sea and air routes connect you economically with London, Europe and the world. Southampton's large deep-sea container port is to be one of Britain's first freports.

Among profit-conscious companies already located in this area are Cyanamid, IBM United Kingdom, Plessey, Pirelli General, Sun Life of Canada and Zurich Insurance.

To Hampshire Development Association, Winchester, Hampshire SO22 5BS, England. Please contact me about relocation opportunities. Name: _____ Company: _____ Address: _____ Type of Business: _____ FR 97/4

To discover how to join them, call Hampshire Development Association on Winchester (0962) 56060. From overseas, dial +44 962 56060. Or telex 477729. Ask for Peter Scruton. Or use the coupon.



The £170,000 or so that can really take you for a ride.

How many vehicles does your company operate? For a typical fleet of one hundred cars and light vans, the probable yearly cost of fuel and maintenance is around £170,000.

As many businesses have come to recognise, a card-based garage services payment system can be the ideal answer to the problem of gaining the tightest possible management control of fleet expenses — providing of course they pick the right card.

Convenient coverage — and a more convenient range of services. Dialcard is accepted at no less than 8,500 garages and filling stations. Its coverage is therefore exceptional — and is not confined to a particular brand of fuel.



Dialcard stands out not only for convenience — a feature you can check as you drive home tonight — but also for the unusual completeness of its services.

In contrast to cards which are for fuel only, the basic Dialcard system is also valid for the other items of expenditure that running a company vehicle involves — servicing, repairs, tyres, exhausts and batteries.

To give you optimum control of vehicle operating costs, Dialcard provides you with

monthly analyses which detail each separate transaction, supplemented by comparative costs-per-mile, fuel consumption and cumulative mileage figures for every individual vehicle in your fleet.

With Dialcard, you automatically obtain the kind of accurate, up-to-date management information that helps to increase the accountability of your fleet as an overhead.

The Dialcard system simplifies expenses administration and accounting routines too.

Instead of possibly hundreds or even thousands of separate bills and till receipts, you receive one single master VAT invoice per month which covers your entire fleet of cars, vans and HGVs.

Isn't Dialcard a management tool you ought to know more about?

To find out more details, ask your secretary to get in touch with Dialcard today.

Dialcard Limited, Wellington House, 154 Upper Richmond Road, London SW15 2SQ. Telephone: 01-735 7331. Telex: 28165.

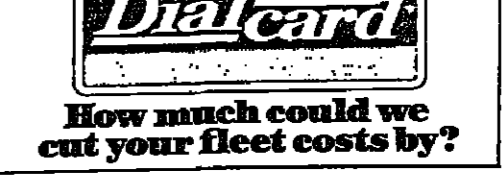

How much could we cut your fleet costs by?

THE ARTS

Cinema/Nigel Andrews

All human—and animal—life is here

White Dog, directed by Samuel Fuller
Daniel Takes a Train, directed by Pal Sander
Big Meat Eater, directed by Chris Windsor
The Heartbreakers, directed by Peter Bringmann
Fords on Water, directed by Barry Bliss



Burl Ives and Kristy McNichol in "White Dog"

"This is the enemy!" bawls Burl Ives as "Carruthers", animal trainer to Hollywood, pointing at a poster of R2D2 in Samuel Fuller's *White Dog*. Fortunately for Carruthers and his tribe, there are still a few rear-guard movie-makers who prefer the live drama of animals to the dinky comedy-drama of robots, and Fuller is one. This great American maverick has been shooting films from the hip for 35 years (including *Underworld USA*, *Shock Corridor* and *The Big Red One*) and *White Dog* is a typical salvo. It loads its barrel with every available topical theme, from rape to racism, and discharges them in a thriller format as lively as it is unsubtle. Fuller's films work on the principle that there are so many roles in you by the end of the film that you won't notice the almost equal number of holes in the plot.

The title four-footer is a white Alsatian stray adopted by struggling young actress Kristy McNichol, who for reasons best known to the scriptwriter (Fuller himself, from a Romain Gary novel) lives in a luxury villa in the California Hills. No sooner has the snowy canine scooped ten out of ten for good conduct by saving Miss M from a midnight rapist than he starts venting his aggression on innocent blacks. Two are savaged, one killed. Was he trained to do this by racist previous owners? And will black trainer Paul Winfield, who helps ruin the Ives-Carruthers animal centre, accede to our heroine's request to help her doggy "unlearn" this tendency? (Yes to both questions.)

The film's Sisyphus struggle is to push the stone of plausibility up the hill of mounting audience protestations. Your sane self keeps crying, "Why not shoot the damned animal and save the cost in human blood?" And the cry is not quite quelled by the reason given for Winfield's tenacity: that the wretched one dog liberated from its racism will stop black-batters training other dogs. This has as much logic as saying that people will stop making bombs if they think that someone somewhere will defuse one of them.

But with Fuller you have to swallow the pipe with the fruit, because he doesn't so much prepare movies for the table as empty them straight down your oesophagus. While credibility survives—for a good hour of the film—the excitement is tremendous: a pounding, prowling camera, a dog who far outpaces the late unlamented

Cujo for ferocity (tremble at the wrinkling snout and blinding fangs) and the tough, pliant charisma of Miss McNichol. And even when credibility totters, it's still more compelling to watch Fuller choreographing Nature red in tooth and paw than to watch, say, George Lucas and Company choreographing the latest line in peripatetic vacuum cleaners.

Ever since Hungarian cinema first lifted the lid on the post-war Stalinesque years, the steam of retroactive outrage has been billowing forth profusely. It billows forth almost literally in Pal Sander's *Daniel Takes a Train*, where the frontiers hotel lodging overnight fugitives from 1956 Hungary swirls with more opaque, expressionistic vapours than could be created by an entire population all smoking cigarettes at once.

These scenes of baroque and batty inferno are the most striking in the tale of two young men who join a refugee train from Budapest to the Austro-Hungarian border in December 1956—there to be trucked across to "freedom"—but who find that crisis night near the frontier ferments their resolve in wholly different ways.

The Jewish Daniel (Peter Rudolf) tastes in one night the tremors of love—with the girl he hopped on the train to pursue—and the chaos of historical perspectives, as beery bickerings break out between the "party-liners" and the "counter-revolutionaries." His soldier friend Gyuri (Sander Zsoter) witnesses a midnight

brawl in which his father, a former secret policeman, goes to the rescue of the very ex-colleague who once betrayed him into jail: which chilly demonstration of how political faith overlaps personal grudge knocks Gyuri's previous certainties likewise for six. Will both young men—or neither—make the final bound into the Free World? Or will they backtrack to the alluring, unsolved ambiguities of Budapest?

Peter Rudolf's marvellous Daniel has the look of a Magyar Buster Keaton—all high cheekbones, noble nose and huge unblinking eyes—and his performance humanises a movie that's elsewhere at once too swirling and too schematic. The foggy post-dubbing badly blurs individualisation of character, and the all-human-life atmosphere of the hotel sometimes makes us feel as if we're signed up for 60 minutes' allegorical hard labour in a Friedrich Durren-matt play. But there are glimmers of passion and precision throughout; and Rudolf plants the kiss of humanity on all his scenes, even those that try firmly to resist it.

Elsewhere the Easter silly season is in full swing. *Big Meat Eater* should turn any sane alimpor into an instant vegetarian. This Gothic caserole of musical, horror film and Sci-Fi ramp—sauce and simmered in would-be spoofery—depresses not by its excesses but by its monotony. The little town of "Burquittam" Canada, responds to the mass convergence of aliens from Outer Space, a zombified Mayor,

a boy scientist, a homicidal butcher called Abdullah and several servings of grilled gangster and hamburgered bound. (Gasp at the slice of spotted meat which records the passing of a Dalmatian.)

This might all have been good unclean fun if directed with more verve by Chris Windsor and with at least a glimpse of galloping gallows wit. But instead it's slow, congealing and vaguely repulsive, like yesterday's dog's dinner. However, it is showing in a double-bill with Bill Forsyth's superb first feature, *The Shining Field*, so perhaps you should gird up your palette and go.

How *The Heartbreakers*, with so many better films teetering on the EEC coast waiting for a boat to Britain, made the trip from Germany is a mystery. The restorable rise of a Ruhr Valley rock group is related for us in song and drama, and directed by Peter Bringmann with all the excitement of a waterlogged *Stardust* or a plastic *Breaking Glass*.

The whirling droids of the eponymous group—including pill-popping fatty Horn (Mark Etcheberry), artful dodger young manager Pico (Michael Klein) and David Bowie clone Freytag (Sascha Dissekamp)—keep trying to "put on the show right here" (or at least rehearse it) while the script trips them up with romantic complications, stray punch-ups and bits of instant philosophising about recession Germany. The only appealing character is Signol the goldfish, Freytag's pet, who gapes in constant and commendable astonishment at the rags-to-rags-to-rags clichés flying all around him.

Barry Bliss's *Fords on Water*, from the British Film Institute Production Board, is a game-some oddity: like *Candide* meets *The Day After Tomorrow*. Two questing innocents—a young black (Elvis Jayne) and a young white (Mark Wingett)—tack to and fro across modern Britain, bound together by the invisible shackles of poverty, joblessness and a crusty, quipping comradeship. En route they meet social injustice and discriminations of class, race and sex, and are regularly struck in the face by Bliss's bawling non-sequitur. ("Education's a fine thing," says one of their Mum's: hurling a book out of a balcony. "Excuse me a minute" says a young man, before throwing himself out of a window.)

The verbal ellipses and surrealisms tilt along throughout (Giri, "You don't even know me"; Boy, "Does a dolphin know the ocean?"); with the unfortunate result that the dialogue has so much more oomph and interest than the imagery that *Fords On Water* might have fared better as a TV play—or even a radio play. You come out optically hungry and humming the one-liners.

Arts Week
 F | S | Su | M | Tu | W | Th
 27 | 28 | 29 | 30 | 1 | 2 | 3

Theatre

CHICAGO
E. R. (Forum): Moving into its second year parodying melodrama in a hospital setting, this emergency room continues its adventures among a young doctor, a receptionist and an authoritarian nurse. (480 3008).

WASHINGTON
Beyond Therapy (Kreeger): Christopher Durang's romantic comedy has all the elements of modern singlism: life including sexing through the personals column of a newspaper and a scene in a hip restaurant, but it reflects more than explores the shallowness of a sort of choices. Arena Stage (486 3504).

NEW YORK
Cats (Winter Garden): Still a sellout. Trevor Nunn's production of T. S. Eliot children's poetry set to trendy music is visually startling and choreographically feline, but classic only in the sense of a rather staid and overblown idea of theatricality. (239 6282).

Opera and Ballet

NEW YORK
American Ballet Theatre (Metropolitan Opera House): The eight-week spring season of Mikhail Baryshnikov's company includes an all-new *Cinderella*, choreographed by Baryshnikov and Peter Anastos. Other season premieres include works by Twyla Tharp and Marvinne van Hamel. Natalia Makarova's new staging of *Paquita* and company premiere of *Six Women's' Tragedy*. *Trud*, the company's favourite in the repertoire, includes *Swan Lake* and last year's premiere of August Bournonville's *La Sylphide*. Lincoln Center (590 9835).

WEST GERMANY
Berlin Deutsche Oper: Toccata has Eva Marton, famous for her rendition in the title role, and Giorgio Lombardi. *Die Entführung aus dem Serail* features Karin Ott and Bengt Brånner. *Die Fledermaus* is directed by Wolfgang Rother and directed with scenery and costumes by Pier Luigi Pizzi. *Die Entführung aus dem Serail* is directed by Wolfgang Rother and directed with scenery and costumes by Pier Luigi Pizzi. (461 1755).

VIENNA
Barber of Seville conducted by Haechen with Elias Schwarzenberg and Wagner. *Volkoper*. (323 4124). *Aida* conducted by Lorenz Maazel with Vergara, Chiara, Vance, Scirra, Pavonetti; Salome conducted by Hollreiser with Armstrong, Hesse, Slanic; *La Cenerentola* conducted by Zedda, Halm, Hinzmeier, Balsta; *Staatsoper* (324/28 55).

PARIS
Messner's Werther conducted by Georges Pretre in Florence's Teatro Comunale production, with a superbly sung title role by Almeda Kraus, admirably partnered by Lucia Valentini-Terrani as Charlotte. Gino Quilico as Albert and Christine Barboux/Marie-Catherine Pyris as Sophie; alternates with Messner-

La Caga aux Folles (Palace): Perhaps this season's outstanding musical comes, like *Evita* and *Cats* before it, at the very beginning of the theatrical year. Despite stellar names such as Harvey Fierstein writing the book and Jerry Herman the music, the best parts of the show are not the hoopla, apart from the first-act finale a la *Gaîté Parisienne*, but the intimate moments borrowed direct: An immediate celebration of the holiday of Broadway in the '80s incorporates gems from the original film like *Shuffle Off To Buffalo* with the appropriately trash and leggy hoofing by a large chorus line. (977 9020).

And Street (Majestic): An immediate celebration of the holiday of Broadway in the '80s incorporates gems from the original film like *Shuffle Off To Buffalo* with the appropriately trash and leggy hoofing by a large chorus line. (977 9020).

Torah Song Trilogy (Helen Hayes): Haven't you heard enough about touching story of a queer? (Backstage to loneliness incorporates all the wild histrionics in between, down to the confrontation with his dying Jewish mother. (944 9450)).

Nine (46th St): Two dozen women surround Sergio Franchi in this Tony-award-winning musical version of the film *Nine*, which like the original celebrates creativity, here as a series of Tommy Tune's exciting scenes. (246 0246).

On Your Toes (Virginia): Gelfing Pannofsky with presumably a genuine Russian accent leads an exuberant cast in the remake of Rogers and Hart's

1936 sendup of Russian ballet tours, complete with Slaughter on Tenth Avenue choreographed by George Balanchine and directed, like the original, by George Abbott. (877 8870).

Brighton Beach Memoirs (Neil Simon): If he wasn't sure not to touch childhood reminiscences now that the Westchester organization has generously decided to name the theatre after the generation's outstanding box office draw. (787 8846).

A Chorus Line (Shubert): The longest-running musical ever in America has not only supported Joseph Papp's Public Theater for eight years but also updated the musical genre with its backstage story in which the songs are used as auditions rather than emotions. (295 6280).

The Shadow Connelly (Royal): A solid out-ten-week engagement at the Public led to this Broadway incarnation of William Saroyan's gentle story of California folk, as interpreted in dramatic by Hall's creator, Cab MacDermott with William Dumassey's libretto. (239 6200).

LONDON
Love (Ambassadors): Leonard Rossiter is a wonderful Truitt in Jonathan Lynn's enjoyable revival of Joe Orton's farce in which a leading role is played by a murdered corpse. The original film is also being revived in the Irish press who is open to offers and party to crime. (866 1171).

The Aspern Papers (Haymarket): Vanessa Redgrave and Wendy Hiller give support to Hall's creator, Cab MacDermott's 1958 version of Henry James's story. The inquisi-

ty's Boris Godunov, conducted by James Conlon, with Nicolai Ghimara in the title role, Marina Balas as Fedotina and Marina Furtak as Xenia, at the Barbican. (425 7550). Bill T. Jones - Arnie Zane and Company, the next wave of American modern dancing at the Theatre de la Ville. (874 9777).

CONCERTS
Concerts of the National Symphony: Conducted by Seiji Ozawa, the National Symphony Orchestra performs a programme of Beethoven's *Symphony No. 9* and Liszt's *Concerto in E-flat major*. (435 6122).

CHICAGO
National Symphony (Concert Hall): Sir Georg Solti conducting Janet Baker, mezzo-soprano, McCabe, Elgar (Thu). (435 6122).

VIENNA
Japanese Oratorio Society, conductor Noritaru Yamada. Handel's *Messiah*; Musilvianer (Wed) (686180). **Vienna Heavy Orchestra** conducted by Charles Munch. (Mon) Pina Carmirelli, violin. *All-Vivoli* programme (Thu). (247 7459).

LONDON
English Chamber Orchestra, conducted by Gustav Kuhn with Kiri Te Kanawa, soprano, Evelyn, Barlow, Cantelmo, and Schubert. *Royal Festival Hall* (Mon). (282 3191).

PARIS
Cycle Acoustique Ina-Gru: Eloy, Roque-Aulina (6.30pm Mon); Smalley, Dufour (8.30pm Mon). Both concerts at the Grand Auditorium. (284 1516).

BRUSSELS
Treasures for the Table: Gold and silverware, porcelain and glass from Vienna, Paris and Brussels, including part of the solid gold service made for the Empress Maria Theresa and Louis XV's silver service offered to her to commemorate the Franco-Austrian alliance. Credit Communal Passage 44 until June.

FREEDOM FOR THE WORKERS!

The benefits of moving your business to Newport can be summed up in a single word. Freedom. Freedom to get on with the job. Freedom from traffic and concrete. Freedom from punishing rent and rates. Above all, freedom to live and breathe in some of the most beautiful countryside in Britain. And you'll find there are substantial grants available, which can help free your capital for investment in the business. Send for our brochure today.

NAME _____
 ADDRESS _____
 TEL. NO. _____

NEWPORT IT'S FREE
 To: Gareth Isaac, Borough of Newport, The Civic Centre, Newport, Gwent, NPT 4UR.

Exhibitions

LONDON
The Tate Gallery: The Pre-Raphaelites. The exhibition, the latest in a series, and its consequent rise in value, has made a proper critical re-evaluation long overdue; and now, with this current and splendid exhibition, the subject is wide open. What had for so long been taken as merely a close and limited movement is clearly shown to be not so except in its earliest years, but rather a loose association of more general relevance. Millais, Maddox Brown, Holman Hunt, Rossetti and Burne-Jones all gain by the chance to be seen on their individual merits, and so emerge as substantial and consistent artists in their own right. The history of British art will never read the same again. Ends May 28.

WEST GERMANY
Cologne: Wallraf-Richartz-Museum. An der Beethovenstrasse, 15th-century school of painting dating from the 17th century, on loan from the Utrecht Zentralmuseum. Ends May 28.

NETHERLANDS
Hans Koper: An exhibition of the ceramics of this Dutch artist and craftsman, who died in 1981, can be seen at the Museum Boyman van Steen in Rotterdam, until May 30. Koper was well known in England, and the display is arranged in co-operation with the British Council and the Sainsbury Centre for the Visual Arts in Norwich.

PARIS
Camille Claudel: 70 sculptures accompanied by paintings, drawings and engravings prove the individuality of Rodin's pupil who, through her

realism and, later on, a sense of the theatrical, found her own way. Musée Rodin. Closed Tue. Ends June 11 (705 0124). **Pierre Bonnard: An important retrospective of the painter whose canvases filled with colour and light glorify the beauty of the human body as he painted time and again. Marthe, his wife, at her toilet, in her bath. His Mediterranean landscapes radiate the same joyous love of nature. Centre Georges Pompidou (278 7995). Closed Tue. Ends May 21.**

TOKYO
Goodman Art of Pakistan. Seibu Museum of Art displays 140 of the most important works from major museums in Pakistan, including Buddhist sculpture, metalwork and daily objects. Ends May 6. **German Expressionist Painting.** Kamakura Museum of Modern Art. Part of the Buchheim Collection currently on tour includes works by 20th-century German artists: Karl Schmidt-Rottluff, Otto Müller, Max Beckmann, Otto Dix, Lionel Feininger. Ends May 9.

WASHINGTON
German Expressionist Sculpture (Hirshhorn): This is the first comprehensive look at works in plaster, bronze, wood and porcelain from the first two decades of this century in Germany. Included in the show of 33 artists and 120 sculptures are Max Beckmann, Emil Nolde, Wilhelm Lehmbruck and Ernst Barlach. Ends June 17.

NEW YORK
Ficcino: The Last Years (Guggenheim): A show of one per cent of Picasso's last decade of work still has 250 pieces in it, showing a restless spirit trying to capture the last personal vision by dint of sheer energy working at a furious pace. Ends May 6.

Painting in the South (National Academy of Design): Nearly four centuries of American South. 110 paintings include Charles Willson Peale, Winslow Homer, Edward Hopper and Archie Gorby. Starting with a waltz, Louis Lomax, dancing around a pole, from 1958, the show covers the gamut of genres from seascapes and landscapes to portraits and modern works to 1980. Ends May 27.

ROME
Accademia di Francia (Villa Medici): In 1864 Claude Debussy won the coveted Prix de Rome, which allowed artists and musicians to study in Rome for two years. He said ungratefully: "Rome is a really ugly city, full of marble, fleas and boredom." He described his room in the entrancing Villa Medici as an "artistic tomb." The city, brimming with life, celebrates the centenary of his stay with an exhibition, Debussy and Symbolism: His symphonic poem, *La Mer*, was composed while staying at Fiumicino near Rome. Ends June 3.

VIENNA
Photographs 1921-1941: More than 100 photographs, not all flattering, of well-known actors and actresses. Ends June 24.

ITALY
Rome: Teatro Olimpico: Piazza Gentile da Fabriano. London Shakespearean, Mozart, Holst, Stravinsky and Schoenberg. (Wed) (823204).

scholar who descends on their Venetian palazzo is played, ponderously, by Christopher Reeve. (939 9322). **A Structure Named Desire (Murray):** Sheila Gish gives the performance of her life as Blanche Dubois in Al-an Strehan's excellent revival. First seen last year at Greenwich, Tennessee, Gish's emotional roller-coaster of a play amounts to one of the best evenings in town. (836 6123).

Saint Joan (Olivier): Staid and stolid National Theatre revival of a play that is finding it increasingly hard to live up to the tag of Shaw's masterpiece. Frances de la Tour is sincere and untheatrical in a fault as the maid, and Ronald Eyre's direction includes medieval pageant, some striking music by Ilona Sekacz and, alas, a disastrous deputy inquisitor from Cyril Cusack. (928 2252).

TOKYO
Cats (Cats Theatre): The specially built tent theatre, excellent set, good dancing and Kabuki-originated music will make the Japanese version worth seeing. Shiki Company, directed by Keita Asari. (329 1001).

Kabuki: Muzumi, Sonozaki Shinju or *Double Suicide* at Sonozaki (Kabuki-za). One of Chikamasa's most famous plays based on a true incident. English programme details, simultaneous earphone commentary. (841 3122).

Kabuki: Go-biki Tsunagi Uma, or *Pulling the Tethered Horse* (Meiji-za). This production is reputed to have cost ¥10m (944,000) and tells the story of a man who disguises himself as various warriors, and a spider in order to avenge his father's death. (867 5131).

WASHINGTON
New York Philharmonic (Avery Fisher Hall): An elbow operation has sidelined Zubin Mehta for six weeks. Conductor to be announced for all-Brahms programme with Isaac Stern, violin (Tue); Gunther Herbig, cello; and a programme of the 19th-century Symphony conducted by soloist Peter Schreier, tenor, Mozart, Sublimeister, Bach, Britten (Thu). Lincoln Center (874 2424).

Chicago Symphony (Orchestra Hall): Sir Georg Solti conducting Janet Baker, mezzo-soprano, McCabe, Elgar (Thu). (435 6122).

VIENNA
Japanese Oratorio Society, conductor Noritaru Yamada. Handel's *Messiah*; Musilvianer (Wed) (686180). **Vienna Heavy Orchestra** conducted by Charles Munch. (Mon) Pina Carmirelli, violin. *All-Vivoli* programme (Thu). (247 7459).

LONDON
English Chamber Orchestra, conducted by Gustav Kuhn with Kiri Te Kanawa, soprano, Evelyn, Barlow, Cantelmo, and Schubert. *Royal Festival Hall* (Mon). (282 3191).

PARIS
Cycle Acoustique Ina-Gru: Eloy, Roque-Aulina (6.30pm Mon); Smalley, Dufour (8.30pm Mon). Both concerts at the Grand Auditorium. (284 1516).

BRUSSELS
Treasures for the Table: Gold and silverware, porcelain and glass from Vienna, Paris and Brussels, including part of the solid gold service made for the Empress Maria Theresa and Louis XV's silver service offered to her to commemorate the Franco-Austrian alliance. Credit Communal Passage 44 until June.

ITALY
Rome: Teatro Olimpico: Piazza Gentile da Fabriano. London Shakespearean, Mozart, Holst, Stravinsky and Schoenberg. (Wed) (823204).

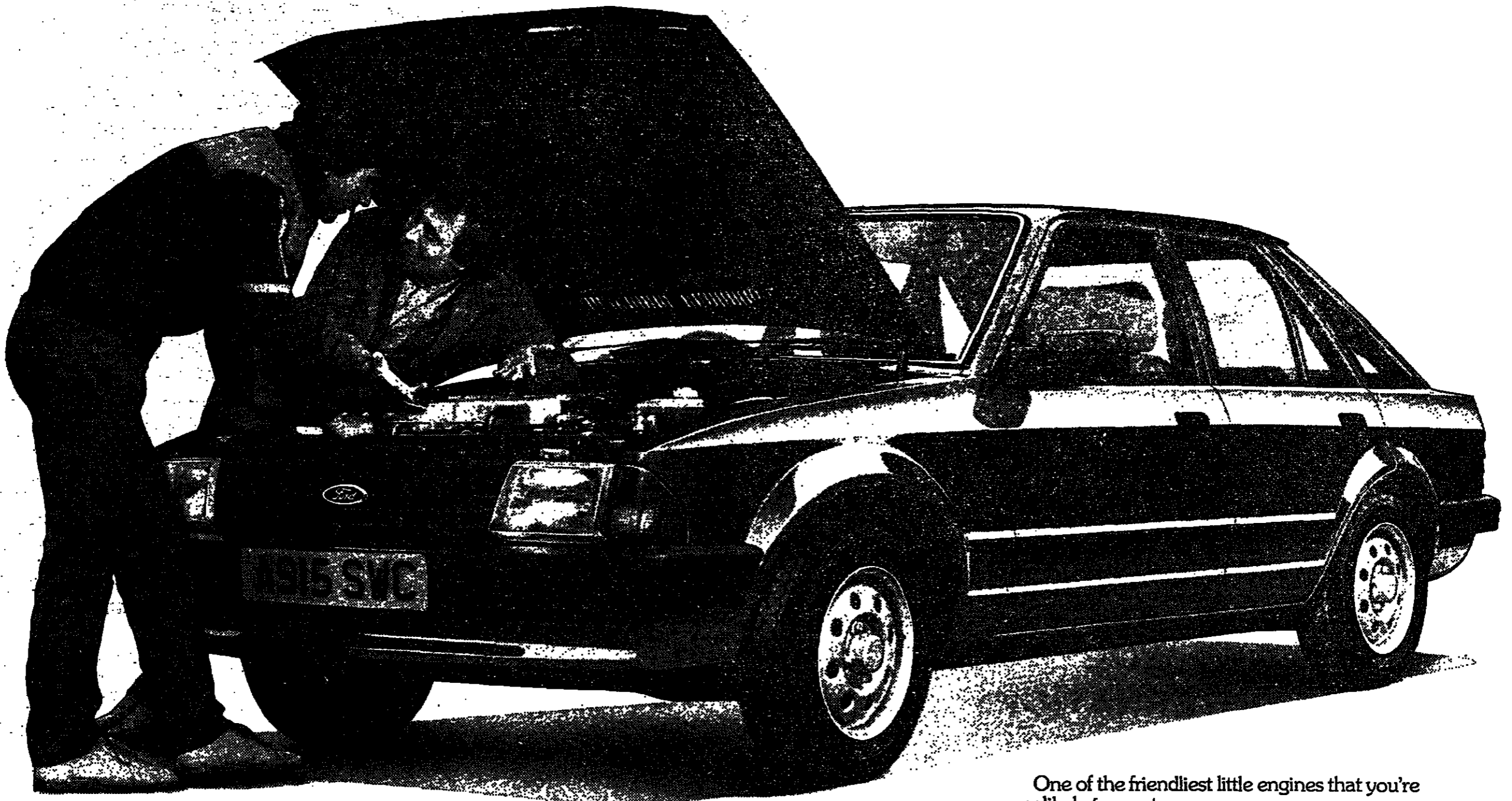

Over 70 mpg.* Over 90 mph.† What on earth has it got under the bonnet?

One of the friendliest little engines that you're ever likely to meet.

It's incredibly economical. Even around town it does over 50 mpg.* Yet it's surprisingly nippy. It can cruise in the eighties and overtake effortlessly.

And it's practically indestructible.

What is it?

Ford's remarkable new 1.6 Light Diesel.

But wait. Aren't diesel engines usually a bit too noisy for the private motorist? Don't they tend to be a little smokey? And aren't they sometimes rather difficult to start up in the morning?

Not this one.

You see, it's not just a commercial diesel that's been adapted for private use.

Nor is it a petrol engine that's been converted to run on diesel. That wouldn't be Ford's way of doing things.

Our new diesel is expressly designed for our three front wheel drive cars; the Fiesta, the Escort and the Orion.

The diesel versions of these cars are great little personalities. They make a lovely happy sound. They pack bags of punch. And they always feel absolutely tireless.

Like little terriers.

Any Ford dealer can service them. (Standard services 12,000 miles). And have you noticed how many garages now have diesel pumps on their forecourts? Diesel costs about £1.70 a gallon.

We know you're sceptical, most people have never really thought of buying a diesel.

But since you're interested enough to read this far, why not go just a little further; pop down to a local Ford dealer and arrange to have a go in one.

Incidentally, it won't just be the engine that impresses you. Our diesel models are just as comfortable and well equipped as our petrol models.

**The new Ford 1.6 Light Diesel.
Quick, quiet, clean.**

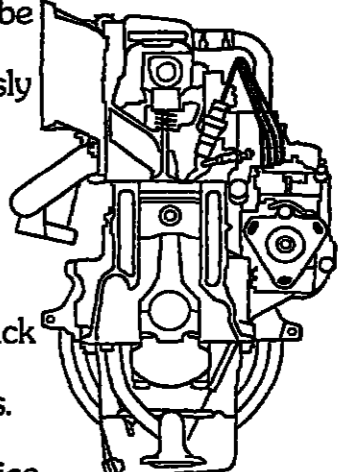

Diesel engines are very simple, very robust, and very cheap to run. They have no distributors or spark plugs. Instead they rely on very high compression ratios (21.5:1) to ignite the fuel.

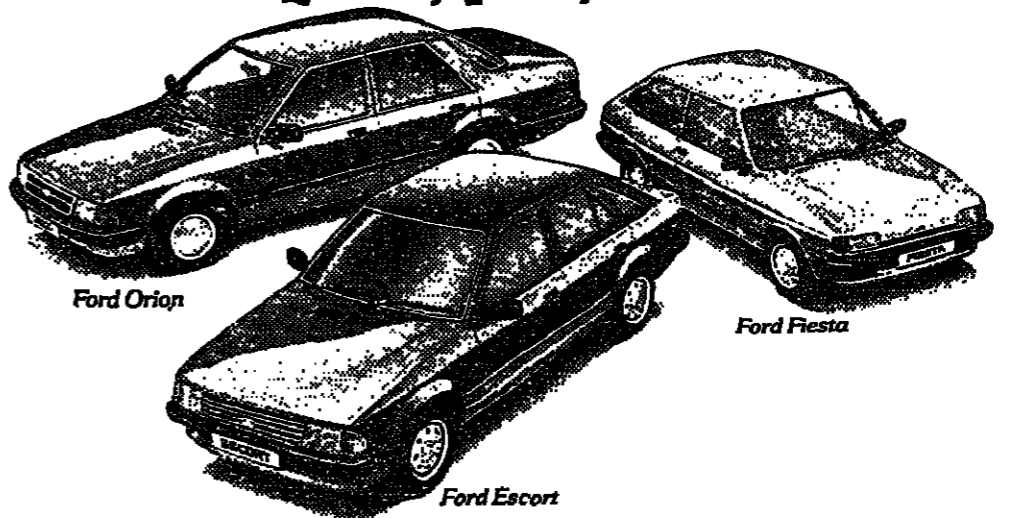

*Govt. fuel economy figures - mpg (litres/100 km). Fiesta 1.6 diesel: constant 56 mph (90 km/h) 74.3 (3.8), constant 75 mph (120 km/h) 50.4 (5.6), urban cycle 56.5 (5.0). Escort Saloon 1.6 diesel: constant 56 mph (90 km/h) 70.6 (4.0), constant 75 mph (120 km/h) 48.7 (5.8), urban cycle 51.4 (5.5). Orion 1.6 diesel: constant 56 mph (90 km/h) 72.4 (3.9), constant 75 mph (120 km/h) 52.3 (5.4), urban cycle 51.4 (5.5). †Ford computed top speed, 1600cc diesel saloons; Fiesta 92 mph, Escort 91 mph, Orion 93 mph.

Ford cares about quality.



THE PROPERTY MARKET BY MICHAEL CASSELL

Stockley's star team sets sights on a sparkling future

JUST OVER a year ago Stuart Lipton quit one of the UK's brightest and most ambitious property development teams and walked off into the shadows to "mess around" on his own.

His mystery departure raised eyebrows around the City of London and led to a wave of speculation over the reasons behind it, ranging from major policy differences with his colleagues at Greycroft City Offices to the state of his health.

Now, the co-founder and former joint managing director of Greycroft is back on the property scene with a new pack of influential friends. There is no doubt that he is fighting fit and threatening to make a previously impressive career look like a practice session for what lies ahead.

Lipton, widely regarded as one of the most imaginative and technically competent developers in the business, has stepped back under the spotlight almost as quickly as he disappeared.

In the last few months, the 41-year-old former estate agent has helped orchestrate the smart, last-minute reincarnation of a quoted property company, established a private development vehicle of his own, assisted in several clever property acquisitions, and picked up one of London's biggest-ever office building projects.

In Lipton's own words: "I had no intention of having so much on my plate so quickly. But that's the way it goes."

Exactly how it goes from now

on promises to be a major pre-occupation for property watchers, who never really believed that a man variously described as "a hopeless workaholic" with "a frightening impatience factor" could ever fade away.

Despite his age, Lipton seems to have been around for ever. Together with Geoffrey Wilson, Land—one of Jim Slater's favourite developers—to Town & City in 1973. Three years later, they and Ron Spinney started Greycroft, and in 1978 merged it with Chaddesley Investments to bring it to market.

By 1981, Greycroft was moving fast and paid £39m for City Offices, a sleepy but sound property company which offered a handy asset base to the high-flying group with a reputation for blockbuster projects.

Lipton was the man who sought out and set up most of Greycroft's biggest and best-known schemes. Like the 500,000 sq ft Cutlers Gardens office development, built in a dodgy location on the edge of the City of London but now full to the brim with tenants; like Finsbury Avenue, the ultra-modern, consortium-funded office scheme undertaken with Godfrey's Bradman's Rosehaugh; like the impressive £70m Victoria Plaza complex nearing completion over London's Victoria Station.

One of Lipton's last initiatives at Greycroft was to arrange the joint purchase of an ageing office tower in Manhattan which promises a big uplift in income after recent refurbishment. Other deals were in the pipeline, but Lipton was not to be involved.

There was, he insists, no hidden drama behind his decision to break away from the team which had worked together so well for so long. "I simply wanted to take time off because I thought I was in danger of going on forever. But I couldn't simply leave everyone up in the air by saying I'd be back a bit later. It had to be a complete break."

So Lipton left to do his messing around. He went to the U.S., where he did some homework on construction management, and he also spent time at the Royal Institute of British Architects, where he is an adjudicator, and with the National Trust.

But, by last autumn, the mounting problems of Trust Securities, the property company headed by Peter Jones, had caught Lipton's eye.

Jones, another one-time estate agent and former joint managing director of Compass Securities, brought Trust Securities to the stock market in 1980. Six months later he revealed plans for a 14m sq ft science park close to Heathrow airport.

But his image as a fast-mover took a knock on the chin with a wildly ambitious and abortive bid for Percy Bilton, the property and construction group. From then on, the company appeared increasingly shaky on its feet and more like the prey than the predator.

Lipton went to see Jones, and says he was struck by the enormity of the problems which Trust faced (subsequently underlined in the 1983 losses of £7.4m) though impressed by the Heathrow scheme's potential.

"It was the ambition of Trust Securities to get planning permission for Stockley Park. My ambition is to build it. Trust acted as though the project was a goldmine and that they had mined the gold. Then they went out and spent its value on a lot of other things, many of them very poor."

The job of making Stockley Park a reality will fall principally to Lipton, who is to be paid an initial £50,000 a year and up to 2.4 per cent of all building costs, to project manage the scheme through Stanhope Securities, his new private company.

He is clearly anxious to get back into the developers' seat, happy to concede that Bernard is the financier and that he is the "nuts and bolts" man.

"We are going to build a business park to beat them all. It will set new standards of excellence, and we will offer a preferred list of architects for

tenants to choose from, people with whom we can work."

The essence of the deal is that, in return for planning consent for 75 acres of high-quality, mixed development, the local authority gets 250 acres of landscaped land and extensive leisure facilities.

A planning application has been submitted for phase one of a project which could ultimately soak up £100m—the Universities Superannuation Fund still wants its option to provide a big chunk of the development finance. Work should begin next year.

But the Heathrow project is inevitably long-term and Stockley has wasted no time in securing earlier profit sources and asset growth.

on to Stockley, which purchased the properties through Morgan Grenfell via a share issue and placing.

All the properties involved offer imminent or medium-term reversions and nowhere is the potential for rental uplift more apparent than in Piccadilly, where Stockley has picked up 188,000 gross sq ft of mixed floorspace—including the Cavalry and R&F Clubs—which now manage to yield the princely sum of £40,540 a year.

Lipton says other acquisitions will be made soon and that Stockley—in true Greycroft style—will stick to London and the south-east and mainly to offices. The U.S., he adds, will no doubt figure in future plans.

But Lipton also has other challenges on his plate—and they do not come much bigger than the proposed £250m redevelopment of London's Liverpool Street and Broad Street stations.

In March, it was announced that, through Stanhope, Lipton had again teamed up with Godfrey Bradman at Rosehaugh to tackle the scheme which had earlier defeated Wimpey and Taylor Woodrow.

Bradman's record for minimising risk and providing large, speedy returns, together with Lipton's development skills, would indicate a much happier outcome.

Lipton accepts that Liverpool Street will add to an already massive workload but emphasises that he and Bradman—

"a good friend and a very clever financier"—were working on it before Stockley came along.

But, whatever project Lipton finds himself on, the general philosophy will be the same. "I am a conservative developer, building at tomorrow's costs determined to achieve quality in the firm belief that the best buildings get the best results. It's a very simple philosophy but people think you are being very gracious when you say it."

How many of our major property companies have portfolios of true quality? You could count them on a couple of fingers. We intend to create another in the shape of Stockley.

Lipton has strong views on the role of good design in a modern environment. "Architecture once had a traditional role to play in the country's social structure. When people like Cubitt and Brunel were building, there was an air of patronage and social improvement. There is very little of that left and it needs to be recreated."

Many architects today are simply incompetent, though the architect invariably also needs educating in assessing and articulating his requirements. There is a mood in the air to tackle these challenges and we intend to play our part."

Lipton believes that, at its best, property should be simple but fun. It should be fun watching Stockley from now on.

Moving fast

Rescue bid

Confusion

Ambitious



35th WORLD CONGRESS OF THE INTERNATIONAL REAL ESTATE FEDERATION

TUESDAY 29th MAY

REAL ESTATE & FISCAL LEGISLATION

Speaker - Sir Desmond Heap
"The Effect of Legislation on Development"

REAL ESTATE APPRAISAL STUDY TOUR

Covent Garden - hosted by Donaldsons

Registration details from:

SECRETARIAT
CONFERENCE ASSOCIATES
FIABCI '84
34 STANFORD ROAD
LONDON W1B 5PZ
01-237 3163

Warehouse & Industrial Properties To Let and For Sale

Chelmsford.....	6,350 sq.ft. and 7,300 sq.ft.
Colchester.....	1,050 sq.ft. to 7,900 sq.ft.
Exeter-Freehold.....	13,000 sq.ft.
Isleworth.....	9,600 sq.ft.
Liverpool-Freehold.....	3,260 sq.ft.
Newport (Gwent).....	7,300 sq.ft.
Peckham.....	4,100 sq.ft. and 4,550 sq.ft.
Wellingborough Enterprise Zone.....	3,000 sq.ft. to 9,000 sq.ft.

DRIVERS JONAS

Chartered Surveyors
16 Suffolk Street, London SW1Y 4HQ
01-930 9731

LONDON SE1

19,110 SQ.FT.

Air

Conditioned

Offices

To be custom-built for a discerning tenant.

RUBENS

Albany House,
Petty France,
London SW1H 9EE

01-222 4848
Telex: 886833

MELLERSH & HARDING

43 St. James's Place,
London SW1A 1PA

01-499 0866
Telex: 24310

FREEHOLD FOR SALE

Ashburnham Road—Bedford
Premises suitable for conversion/development
Close to Bedford Town Centre
In close proximity to British Rail Station
(St Pancras 45 minutes)



2 Long Leases for Designated Executive Offices with Car Parking and Storage

29 Gresham Street

INoble Street
UNIT 10 130

UNIT 2 2760

St Quentin

Tel 01-236 4040

NEWCASTLE-upon-TYNE

City Centre
DEVELOPMENT OPPORTUNITY
Extensive Retail Property
Suitable for division
FREEHOLD

EDWARDSYMONS & PARTNERS Tel 01-834 8454
56/62 Wilton Road, London SW1V 1DH

K for Industry

GREENFORD A40 New Factory/Warehouse Units TO LET IMMEDIATELY

HEDGE END, SOUTHAMPTON Modern Industrial/Warehouse Units 12,400-24,800 sq ft TO LET

MAIDSTONE, Kent New Industrial/Warehouse Units TO LET

SOUTH WIMBLEDON Warehouse TO LET

WATFORD 1 1/2 miles from J5 of M1 Light Industrial/Warehouse Units 5,000-10,000 sq ft TO LET

WHITTINGTON, Essex 33,000/17,200 sq ft on 3.26 acres Modern single-storey Warehouse May be suitable for retail use TO LET

WHITLESFORD, Cambridgeshire 65,300 sq ft Working Complex FOR SALE FREEHOLD

WOOD GREEN N22 Units from 8,000-24,000 sq ft GENUINE RENT FREE PERIODS TO LET

King & Co

1 SNOW HILL LONDON EC1
01-236 3000
Manchester Leeds Birmingham Edinburgh Brussels

ST. JAMES'S SQUARE LONDON SW1

Office Suite To Be Let

1,243 sq. ft.

Herring & Davis Chartered Surveyors
26/28 Sackville Street
London W1X 2QL
01-734 6155

Tomorrow's world... today.

Swindon's reputation as the expanding centre for knowledge-based business continues to grow... and so too does Kembrey Park.

Whether your company needs space for offices, light production, research or distribution, Kembrey Park can provide it... in stunningly practical, yet beautiful buildings.

Consider, for example, Maple. A single unit of 56,000 sq. ft. available immediately, designed for H.Q. offices, production, distribution, or research. The offices are fitted with all the amenities you'd expect in a major development and the remaining space can be tailored to suit your company. And there's parking space for over 100 cars, as well.

On-site management and computerised round-the-clock security are all part of the Kembrey Park service.

Sun Alliance are the developers of Kembrey Park and we shall be pleased to discuss turn-key construction to suit your company's special requirements. What's more, you'll find we understand the needs of today's knowledge-based businesses.

If you're planning for new accommodation in the Thames Valley, find out more about Kembrey Park.

Available today at Kembrey Park

Maple	A high specification, H.Q. office, research distribution and/or light production facility of 56,000 sq. ft.
Mulberry	A two-storey square plan building of 25,000 sq. ft. designed for offices, R & D, data processing and light production.
Cherry	Suites from 1,000 sq. ft. up to an entire building of 36,000 sq. ft. for offices, clean light production, R & D, data processing and design activities.
Ash	High quality starter units offering areas of 800 sq. ft. upwards on 'pay as you grow' lease terms.

For further details contact:
Jim Sheridan or Alan Bate
01-408 1161 or 0793 33155

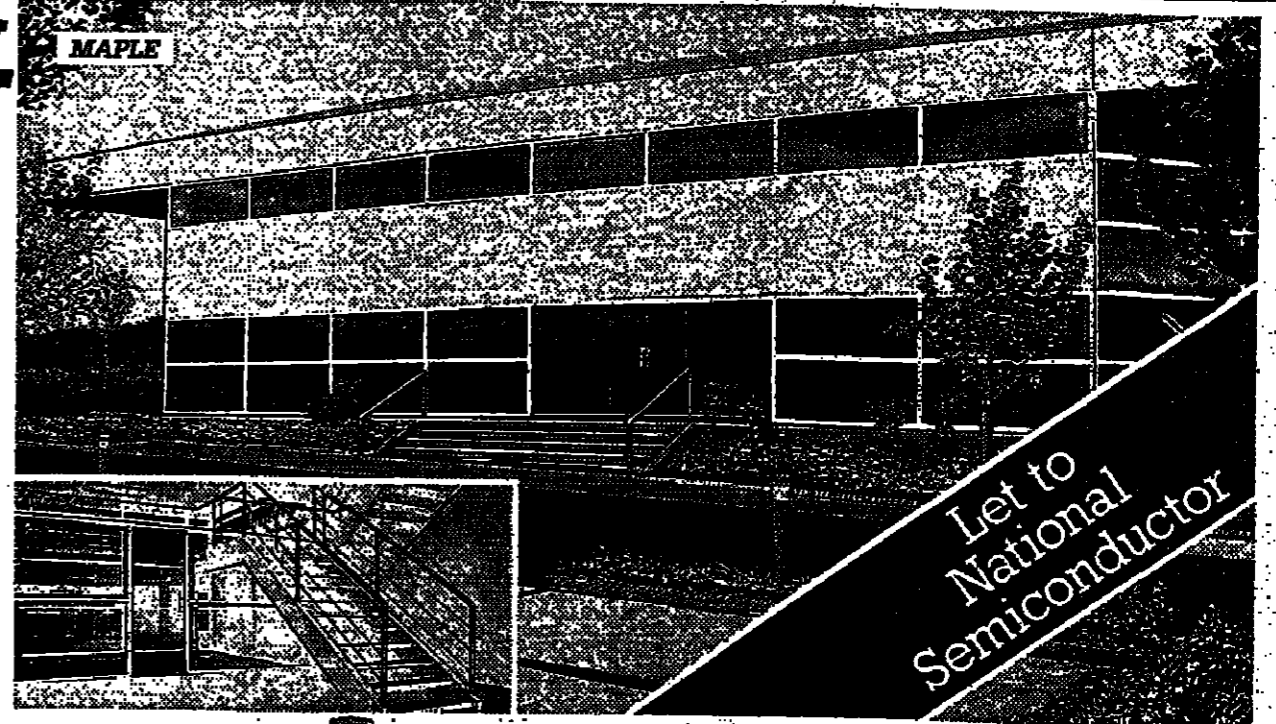

Kembrey Park, Swindon

A Development by Sun Alliance Insurance Group

READY FOR OCCUPATION

CRAWLEY FRIARY HOUSE
NEW TOWN CENTRE OFFICES
24,225 SQ. FT. TO LET

- * Opposite Crawley Station
- * BR * Landscaped Grounds
- * Parking for 91 cars
- * Adjoining shopping centre

Edward Rushton
01-493 6787
Stiles Horton Ledger
0293 548331

ST MARY'S COLLEGE FENHAM
NEWCASTLE UPON TYNE

FOR SALE FREEHOLD

Established Higher Educational Campus of interest to Research, Foundation or similar users

230,000 sq. ft. in 9.2 acres of grounds

FOR FULL DETAILS APPLY—

GERALD EVE & CO. CHARTERED SURVEYORS
18 SAVILE ROW LONDON W1X 2SP
01-437 0488

LAMB & EDGE CHARTERED SURVEYORS
GRAINGER HOUSE 36 BLACKETT STREET NEWCASTLE UPON TYNE
0432-612361

Accommodation in Kent

Ideal for corporate purchase. Residential accommodation in secluded surroundings, but close to motorway and rail communications, Continental ferry terminal and airport facilities.

The site is fully serviced and provides excellent on-site accommodation for international companies or organizations with Anglo-European operations. High security needs or Service accommodation are other possibilities.

You may have other requirements! To find out more please write to:

Box No. 7 9065
The Financial Times
Becken House,
10 Cannon Street,
London EC4A 3DF

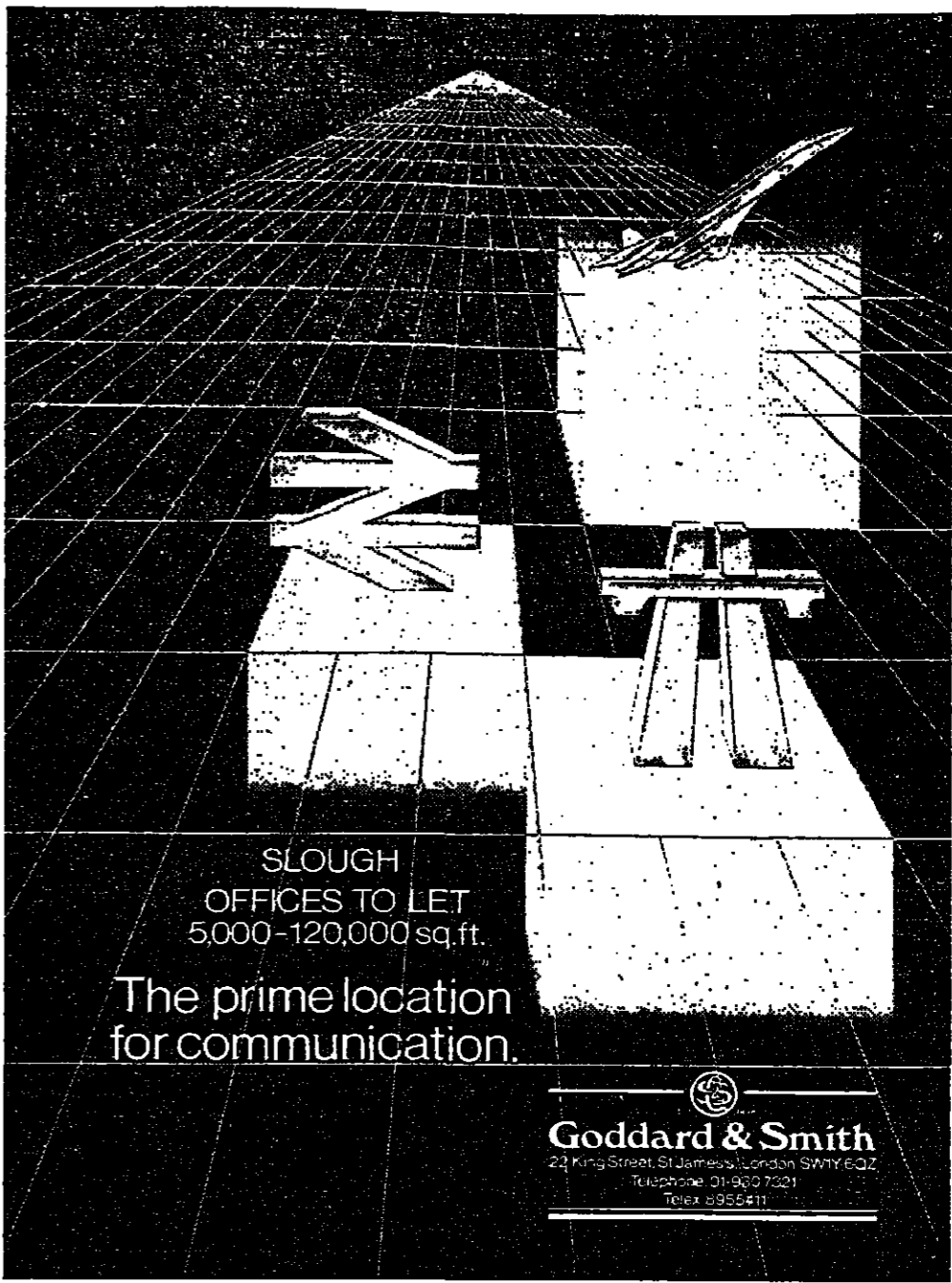

SLOUGH
OFFICES TO LET
5,000-120,000 sq. ft.

The prime location for communication.

Goddard & Smith
22 King Street, London WC2E 9EQ
Telephone: 01-930 7321
Telex: 895541

Seven Sisters, London N4
Superb New Warehouse and Factory Units
13-39,000 sq. ft.
Full Heating & Lighting
Large Yards
LOW RENT

GOLDENBERG & CO.
01-4914101

53 PALL MALL, ST. JAMES'S S.W.1

LEASE FOR SALE
6,500 sq. ft.

Prestige self-contained office building

- * Air-conditioned * Carpeting
- * Display frontage to Pall Mall * Telephone and Telex

Rohleder Lumby
Chartered Surveyors 22 Old Bond St. London W1X 2DA
01-409 2867

LETCWORTH HERTS.
2 Acre Industrial Site
FOR SALE

Price £360,000

Bainstow Eves
767 High Road, North Finchley, London, N12 8LJ
01-448 1414

Enquiries are invited from Principals interested in acquiring land at Winchester having development potential.

Please write to Box 1908, Financial Times, 10 Cannon St., EC4A 3DF

Property Investment Group with institutional share holding wishes to purchase for cash investment Companies with commercial or industrial portfolios.

Ref: MDS

SOUTH HUMBERSIDE
Boltgate Farm, Eastoft
294 Acres

A First Class Arable and Stock Holding with good house and buildings. All Grade 1 land within a ring fence.

NORTH HUMBERSIDE
Elsdon 176 Acres prime Grade 1 and 2 arable land in 3 lots.
Skegby 20 Acres of Grade 2 and 3 arable land in 2 lots.
Barby-on-the-Marsh 88 Acres of Grade 1 arable land in 5 lots.
All for sale by Tender with Vacant Possession

Joint Agents:
Joplings, 10 North Street, Ripon, North Yorkshire. Tel: 0765 4428
G. H. Evison & Sons, 30/32 Newwood, Beverley, North Humberside. Tel: 0482 801232
Solicitors: Messrs. Pearson Burn & Coombes, 4 Broadgate, Helmsley, North Yorkshire. Tel: 0438 70207

Premises, Premises.

Tick below for the land or premises you are looking for in Birmingham.

Industrial/Commercial premises in the city:

<input type="checkbox"/> below 5,000 sq. ft.	<input type="checkbox"/> 5,000-10,000 sq. ft.	<input type="checkbox"/> 10,000-20,000 sq. ft.
<input type="checkbox"/> over 20,000 sq. ft.	<input type="checkbox"/> Factory/Warehouse units.	<input type="checkbox"/> Industrial Estates
<input type="checkbox"/> Shops	<input type="checkbox"/> Offices	<input type="checkbox"/> Industrial & Commercial Sites

Name _____
Position _____
Company/Address _____
Tel _____

Or telephone Richard Perkins FRICS
021-235 3682/4693 or see PRESTEL *2022834*

City of Birmingham
Development and Promotion Unit
Council House, Birmingham B1 1BB
BIRMINGHAM—THE BIG HEART OF ENGLAND

DEBENHAM TEWSON & CHINNOCKS
Chartered Surveyors
44 Bishop Street, London W1Y 1YB
01-408 1161

4,480 SQ. YDS.
(or thereabouts)
CENTRALLY LOCATED
FREEHOLD COMMERCIAL
DEVELOPMENT SITE
SUTTON IN ASHFIELD

NOTTS

For Sale by Public Tender
Offers close 6th June 1984

COLIN BENTLEY & PARTNERS
26 Albert Street
Mansfield
Telephone 0623 25606

INTERNATIONAL PROPERTY

ONE RODEO DRIVE BEVERLY HILLS

THE ULTIMATE RETAIL LOCATION

North West Corner of Rodeo Drive and Wilshire Boulevard Beverly Hills, California

Plans approved and development negotiated for a 3-story retail building of 17,000 gross square feet

FOR SALE

All Inquiries:

Jones Lang Wootton
523 West 6th Street
Los Angeles, California 90014
(213) 624-2800 Telex: 4720026

California-Continental Realty Corp.
2029 Century Park East, Suite 600
Los Angeles, California 90067
(213) 277-7871

Major Offshore Financial Centre CAYMAN ISLANDS

For sale by public auction

Newly completed 60,000 sq. ft. prime office building in central Georgetown, Grand Cayman is to be sold by public auction at 10 am on Tuesday, 15th May 1984 at the Royal Palms Hotel, Grand Cayman, Cayman Islands, British West Indies.

For details apply to:- Hadsphatic International Ltd, Johnston House, Hatchlands Road, Redhill, Surrey, England. Telephone Reigate (07372) 42466. Telex 27641.

Or:- Maples and Calder, PO Box 309, Grand Cayman, Cayman Islands, British West Indies, Telephone Cayman (809-94) 92081 Telex CP (0293) 4212.

The auction may be cancelled or postponed at any time without notice of the property owner.

FOR SALE (25 km from Geneva)

INDUSTRIAL BUILDING

In Gland (near Nyon) in industrial area

- surface of interior: 2500 m²
- surface of annexes 610 m²
- plot of land 5460 m²
- possibility for extension

The building is extremely well equipped and the interior can be easily transformed.

Situated close to highway and railway.

Free beginning of July 1984

For further information please call:
INTERSEMIX S.A.
Tel. (Switzerland) (022) 64.35.51

MODERN, AIR-CONDITIONED WCI OFFICES
20,000 TO 94,000 SQ. FT.
WITH AMPLE CAR PARKING
TO LET
ON UNUSUALLY ATTRACTIVE TERMS

Richard Main
Chartered Surveyors
01-623 6685

OUTGOINGS

PRIME CITY OUTGOINGS £55psft
CITY HOUSE EC1
STILL AT LESS THAN £16psft
FROM 6,205-31,905sqft
01-236 4040

FOR INVESTMENT

READING FREEHOLD OFFICE INVESTMENT
2,298 sq ft + 12 C/P spaces
let on FRI lease to Chartered Accountants at £19,500 pa exclusive.
Price £300,000
Ref: DVM
GIBSON ELEY
9 Castle Street, Reading RG1 7BB
Tel: 0734 286211

INVESTMENTS FOR SALE

100% S.A. (West London) superb 300 sq. ft. to units 649,000 to 839,000. Rental guaranteed. Major London and Paris. 01-433 2397

THREE ADJOINING BUILDINGS in Bayswater in excellent condition, part-leased. A great potential to increase income of £21,000 to £275,000 freehold. Tel: 01-221 2033.

OFFICES TO LET

CHEAM—Beautiful new site office building, 20,000 sq. ft. with parking for 10 cars. Adjacent to Queen Station Leonard Green Park. 01-433 2397

MAYFAIR—Suite of luxury furnished offices available immediately in prime location. Ideal for senior company directors. Secretarial services in-house. Allocation Administration 01-493 8166.

TO LET

REPPINGHAT—Self-contained, refurbished air-conditioned banking and office building. 4,000 sq. ft. Tel: 01-523 9161. Ref: GRS.

THINK DECENTRALISED

KINGSTON TOWN CENTRE
3,000 Square Feet
New Self-contained Office Suite.
Air-conditioning, Car Parking.

CROYDON
Modern Offices Assignment.
2,825 Square Feet approx.
All amenities plus parking.

SLOUGHTOWN CENTRE
Preliminary Details.
2 New Self-contained Office Buildings
2,600 Sq.Ft. each. All amenities.

Further Details Available Ref: IKC
01-248 5022

Chestertons
Chartered Surveyors

MORTGAGES
on Commercial, Industrial, Residential Properties
—at competitive rates
Write or telephone:
Hirsch Mortgages (Int'l) Ltd.
Europe's leading Mortgage Brokers
18 Berkeley Street, W1
Tel: 01-625 8061 - Telex: 28274

MAYFAIR
SUPERB GROUND-FLOOR SHOWROOM/OFFICES
with frontage and car parking

Sole Agents:
BARRINGTON LAURANCE
01-409 2222

QUEENSLAND AUSTRALIA
FREEHOLD CATTLE FATTENING PROPERTY

384 HECTARES (9.545 ACRES)

Situated 30 miles from Townsville with carrying capacity of 2,000 head. Abundant at Townsville, which has an international airport with direct links to Singapore. Deep sea port and railhead. Local industries include tourism (casino under construction, Great Barrier Reef, etc), cattle, cane and rice growing, and mining.

Property is approved for subdivision into 100 Acre Lots for sale as Hobby Farms

Auction May 29 1984 — offers considered prior

Write to Richard Broadhead
c/o Rex Prior Real Estate Pty. Ltd, Box 5880 MBO
Townsville, Queensland, 4810, Australia for details - Tel: AA 47807

SWITZERLAND ATTENTION FOREIGNERS

On MAY 20th it will be decided by referendum whether or not Switzerland may continue to purchase arms and munitions in Switzerland. It is very likely that after that date they will no longer be available for foreigners, except for the limited quantities of munitions which we still have a number of armaments in stock. Prices from Swiss 122,000 with interest margin of 6% to 8% per month. Make your deposit now. Return guaranteed if purchase is not completed. Contact: Globe Plan SA, Rue Michodière 24, CH-1005 Lausanne, Switzerland. Tel: (021) 22 35 12. Telex: 25185 MELIS CH

HAMBURG/GERMANY

Representative industrial office building with 2,000 sq m production and storage space completing very nicely together for sale or leasing available. There are further 13,000 sq m available and expansion is in every view possible. The plant was for more than 8 years the producer of a world famous aperitif and is very favourably situated trafficwise.

If you are interested in this situation please contact us at:
Box 7002, Financial Times, 10 Cannon Street, London EC4A 4BY

PUERTO BANUS MARBELLA RESTAURANT

First class seafood restaurant in Spain's most fashionable resort. 12 seats inside and out. Fully equipped. Annual turnover approx. £160,000. Freehold £100,000. Leasehold £50,000 + £700 per month.

For details:
Tel: 01-726 8248
Telex: 89281PARK

BUSINESS OPPORTUNITY MARBELLA BEACH FRONT

7 furnished studio apartments in luxury block with own pools. To produce approximately 15 per cent p.a. rental income.
£118,000 Freehold

For details:
Tel: 01-726 8248
Telex: 89281PARK

FINANCIAL TIMES

BRACKEN HOUSE, CANNON STREET, LONDON EC4A 4BY
Telegrams: Finanimo, London PS4. Telex: 8954871
Telephone: 01-248 8000

Friday April 27 1984

Cutbacks at British Steel

SINCE nationalisation in 1966 taxpayers have supported the British Steel Corporation to the tune of £12.4bn (in 1982-83 prices). Despite drastic surgery since 1980 the central problem still facing BSC is the need to bring capacity into line with demand. Unless this is achieved, the corporation will remain a burden on taxpayers for the foreseeable future.

So much the House of Commons Trade and Industry Committee seems to accept in yesterday's report on BSC's prospects. Yet, having squared up to the central issue, the committee nevertheless finds itself unable to propose any action that BSC might take to reduce capacity.

BSC's management is in no doubt about what to do. Its expected trading loss in 1983-84 of less than £181m is a big improvement on last year's £386m loss. However, Mr Bob Haslam, BSC's chairman, knows further progress towards the breakeven which the Government is seeking is improbable while BSC's plants run at only 60 or 70 per cent of capacity. The corporation reckons the best way to restore profitability is to close one of its three strip mills—Ravenscraig is the obvious choice.

Losses

This would save about £90m a year and more than offset the losses incurred by using three mills. But the closure—which BSC is likely to propose in its new corporate plan—would curtail one existing government policy.

The committee has three arguments to support its opposition to irreversible capacity cuts. None, ultimately, is convincing. The first is that the mills have different characteristics—for example, only Ravenscraig is capable of making the extremely pure steel needed in North Sea construction work—and that since some customers would not be willing to transfer from the closed mill to the two in production, BSC would lose market share. (After Llanwern, for example, Ford of Europe might prefer a non-British source.) This has happened after past closures but BSC maintains that this time it would keep almost all its customers.

The second objection concerns future demand. Is BSC, despite its good short-term forecasting record, unduly pes-

simistic about medium and long term prospects? While two mills might have difficulty meeting a 10 per cent increase in demand—as occurred in 1983—most of BSC's exports are outside the EEC and at uneconomic prices, so it would have sufficient scope with two mills to break into more profitable EEC markets—where its export showing is very poor. It should also be remembered that the European steel market is itself in secular decline.

The third objection brings in the European dimension more fully. The committee argues that BSC is now one of Europe's most efficient producers, and the one that has so far made the biggest capacity cuts. This is fair comment but the British home market has declined the most sharply, while BSC was initially among the least efficient producers. A further complaint is that BSC's European rivals benefit from hidden energy and transport subsidies.

But refusing to make capacity cuts until other EEC producers show their retrenchment commitments is a doomed strategy. Every European producer deludes itself if it thinks it can keep a little excess capacity without its rivals doing likewise. The net result would be a lot of excess capacity and further losses all round. Even if, by acting now, Britain does end up with a slimmer steel industry than most of Europe, this would not necessarily be against the national interest: prospective returns in steel are lower than in many alternative industries. Equally, it makes no economic sense for Britain to emulate its rivals' wasteful covert subsidies.

Commands

One of BSC's main headaches is its lack of operational autonomy. It has to heed sometimes conflicting commands from Brussels and Whitehall. The industry is no longer the size it once was and will inevitably be squeezed further by Far Eastern competition. It is anomalous that ministers should still be involved in its strategic decisions. The Government should give BSC the freedom to adjust capacity to demand as it thinks fit: the closure of one of BSC's strip mills should therefore not be ruled out. The lesson from the past is that delaying difficult decisions only makes the eventual adjustment more painful.

Hidden cost of helping exports

THERE IS nothing especially meritorious about being an exporter, even in a trade-dependent nation like Britain. Thriving export industries do of course help maintain the standard of living to which we have become accustomed—but then so do importers, even if their contribution to the economy is never honoured with Queen's awards.

The exporting fraternity has always been favoured: even the present government, committed as it is supposed to be to the free play of market forces and rapid restructuring of British industry, has a strong mercantilist streak.

So yesterday's cry of pain from the National Economic Development Office and the Confederation of British Industry about a Whitehall economist's critique of export subsidies for capital goods suppliers was only too predictable.

Debate

In broad terms, the government economists under Mr Ian Byatt, deputy chief economic adviser to the Treasury, concluded that interest rate subsidies and soft credits via the aid programme were a discriminatory, inefficient and expensive use of taxpayers' money.

The first point to be made is that this debate should have taken place months ago. The Byatt report was completed at the end of 1982, but not released until the end of this January. Its main purpose was to arm the Government for negotiations in the OECD about how to check the race to provide ever-cheaper fixed-rate credit to developing countries. At the time Byatt reported, Britain was spending nearly £800m annually to make up the difference between OECD "consensus" rates and the commercial cost of money. But since last autumn, thanks largely to U.S. pressure, the OECD has closed the gap and installed a mechanism to ensure that it remains reasonably narrow. The report has changed the crux of his argument has not. This is that there is very limited justification for the view that Britain must automatically match the ploys of its competitors in order to maintain a

presence in the worldwide power construction and process plant markets. It is the fear that Britain might unilaterally disarm that lies behind the present furor.

The UK has set aside some 500m of 12 per cent of its current bilateral aid budget for project-related handouts to help secure orders in the Third World. The acknowledged leaders in this game of mixing credits with aid are the French and perhaps the Japanese. The U.S., which is fiercely anti-subsidy in principle, has recently entered the lists but for reasons of which Byatt would approve—namely to threaten the rest with unbearable competition should they push the game too far. As Byatt notes, if subsidised foreign competition is the rule not the exception, then governments will have to support future as well as current capital goods exports.

The big contractors and their suppliers, the main beneficiaries of this export support, are entitled to challenge Byatt's conclusion that the spin-off for Britain from large overseas orders is relatively small and the cost of keeping their employees at work inordinately high. They may continue to convince governments that theirs is an industry deserving special treatment.

Subsidies

But they cannot escape the question of how far Britain can really afford to match the prodigality of others. Nor can they seriously wish to live in a world of phoney competition for overseas projects of often questionable value.

It would be unrealistic to expect any government to take literally the recommendations too literally. The dislocation to British industry and jobs caused by unilateral withdrawal from the subsidy game might be rapid and far-reaching. If Britain wants to stay in the project business, taxpayers will have to pay the price. But the Government should keep export subsidies on a tight rein and do its level best to ensure that the OECD, having successfully tackled interest rates, puts a stop to the mixed credit spree.

THE FINAL countdown has begun for Creusot-Loire. France's leading heavy engineering group has now three months in which to draw up a new restructuring plan if it is to stave off bankruptcy.

The decision by the board to seek temporary protection from the firm's creditors means that Creusot-Loire is the first major French private group to have been brought to its knees by the recession. The company employs 29,000 people and has a turnover of more than FF 17.5bn (£1.5bn). The comparison being drawn in Paris yesterday was with the collapse of AEG-Telefunken, the West German electrical group. It is also the first time that the French Government has allowed one of the flagships of French industry to be drawn before the courts because of its financial troubles in a way that could be damaging to its worldwide reputation.

Nobody actually believes that Creusot-Loire will go into liquidation. The French nationalised banks are already too deeply involved in its affairs and the group has profitable plants in its energy and rail transport divisions. But, equally, the French Government does not want to be seen to be bailing out a major private company whose difficulties it largely created. In that sense the joint decision on Wednesday by M Jacques Delors, the Finance Minister, and M Laurent Fabius, the Industry Minister, to refuse fresh financial aid is a symbol of its new, less interventionist approach.

It also reflects the determination of the Government not to repeat its bitter experience on taking office of nationalising loss-making groups of steel plants. Under French judicial procedure, it is now a court official working with Creusot-Loire who will have the task of checking that additional nationalisation measures go far enough to stem its losses and provide the FF 3bn in equity capital that Creusot-Loire needs to get back on its feet. The group, which has already exhausted its shareholders' funds, said on Wednesday that its assets' worth was now substantially negative.

Creusot-Loire is known around the world mainly as a manufacturer of big project engineering group. The group's main remaining businesses are in nuclear plant contracting, hydraulic turbines and railway equipment. All are in partnership with other groups and so any restructuring is likely to occur internally or by bringing in new shareholders.

For example, Creusot has a 50 per cent stake in Framatome, the nuclear power plant construction company. The remainder is held by the French atomic energy authority. It seems likely that Alstom-Atlantique, which is interested in buying at least part of Creusot's stake.

Similarly, there is likely to be an internal solution to

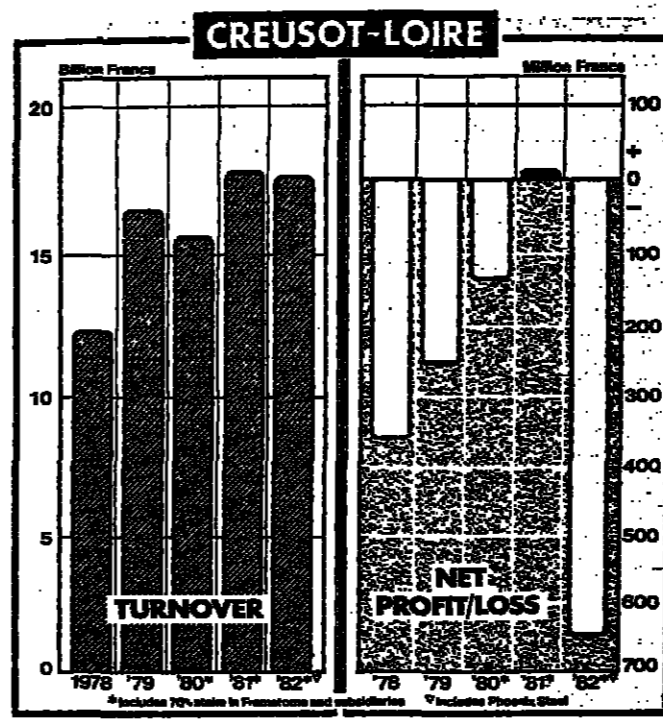
M. JACQUES DELORS
Creusot-Loire chairmanM. JACQUES DELORS
French Finance Minister

The next three months thus provide a breathing space in which the Government, the banks and Creusot-Loire's shareholders will be involved in a bitter struggle over the company's future. But the major battle already shaping up is between the Schneider group, which has 55 per cent in the holding company controlling Creusot-Loire, and the Government. After the Government announced that it would not provide more cash, the Schneider board shot back on Wednesday night by saying that it no longer saw itself bound to provide a FF 200m capital increase for Creusot-Loire agreed in November as part of Schneider's FF 720m contribution to the FF 6bn rescue package signed at the time.

The Government believes that the Schneider group—its own mammoth engineering conglomerate in which complicated cross-holdings disguise the real ownership—is holding back on

providing fresh funds in the belief that the state will step in instead. Schneider maintains that its own shareholders' funds have already been drained by Creusot-Loire's difficulties.

Short of unexpected concessions from the Government or the banks, Creusot-Loire is likely to be forced into a number of unpleasant actions. The first further cutbacks in its 29,000 workforce. M. Didier Pineau-Valencienne, the company's chairman, announced 4,000 job losses last year and said that a further 6,000 were at risk. But since then the group's difficulties have worsened with the downturn in the capital goods market and an unexpectedly weak order book last year.

The second measure is likely to be further asset sales to raise cash. An independent report recently commissioned on the group's operations identified as one of its two main sources of weakness, the collapse of shareholders' funds. M. Pineau-

Valencienne has already taken the asset sale trail in selling in November 20 per cent of Creusot-Loire's 70 per cent stake in Framatome, the nuclear reactor company.

A possibility now must be the shedding of its profitable turbine manufacturing subsidiary Neyric. The third measure is one that the group has already itself proposed: its remaining steel activities—Phoenix Steel of the U.S., the manufacturer of heavy plate for the nuclear industry and its foundries and forges to Creusot for its heavy engineering division—had a major role in last year's losses. Creusot-Loire would like to be rid of most of them.

It also wants — a fourth element in any further rescue package — to renegotiate its stake in Framatome whose future now looks less rosy with the curtailment in the French nuclear programme. M. Pineau-Valencienne believes that the group can

return to profit in concentrating on its "hard core" activities, nuclear engineering, hydraulic power, high-speed trains and metro equipment, gas compressors, and specialised military materials. The Government accepted this view in November but M. Pineau-Valencienne's judgment has inevitably been called into question by the sharp deterioration in the group's prospects since then.

In his report to shareholders on December 31 last year M. Pineau-Valencienne expressed his "confidence" in the group's "recovery." On Wednesday, in seeking temporary protection from its creditors, the Creusot-Loire board announced losses of FF 1.8bn last year—some FF 400m worse than anticipated. The company expects a further FF 700m deterioration this year.

M. Pineau-Valencienne is at the eye of the storm because he is both chairman of Creusot-Loire and of the Schneider group. A quietly-spoken gradu-

ate of the Harvard Business School and a firm believer in American style management, he took over Creusot-Loire in 1982 in an effort to stem losses by exerting greater financial discipline. He had been appointed head of Schneider only two years before. Creusot-Loire's long-term problems have been mainly due to its heady expansion into too many fields. One of its most serious errors was its costly investment in Phoenix Steel of the U.S., which has also temporarily sought protection from its creditors under Chapter 11 procedures.

Since the end of last year M. Pineau-Valencienne has been reorganising the company to give it more of a U.S. style structure. This has involved creating new divisions based around the group's main activities, operating with more autonomy and under a central holding company.

Before embarking on this, M. Pineau-Valencienne conducted a tightrope negotiations with the banks and the Government which culminated in the FF 6bn package in November. He said at the time that FF 6bn would be needed and warned the Government that without adequate funds the company would have to file for bankruptcy. His threats were thought to have a large element of bluff.

Of the FF 6bn, over FF 2bn came from the nationalised banks and the Government in the form of subsidised loans. The rest was provided through asset sales, including the hiving off of much of the group's steel division, to the two state owned groups—Saclor and Usinor. Schneider also agreed to put up FF 720m in increased capital by 1986 and to guarantee FF 300m of subordinated loans.

Since the latest crisis broke a month ago, the group has indicated it would need a further FF 2-3bn cash injection. This figure is based on what it considers the size of the losses it made on its steel activities between 1978-83 as a result of the Government not providing Creusot-Loire with the assistance given to other steel groups.

A FAR CRY FROM THE HEADY EXPANSION OF THE 1970s

Creusot's participation in Framatome, the French railway equipment manufacturing concern that makes, among other things, the French high speed (TGV) trains. Creusot shares a 50 per cent stake in Framatome with Schneider, which, like Gecost, is part of the Empain-Schneider group, and MTE.

The group will probably try to hang on to its other large businesses, such as SHF International, which makes oil exploration equipment. Although it has sold off its plant contracting and engineering business, the group is also left with a lot of plant manufacturing capacity, notably for heat exchangers, compressors and pressure vessels.

World markets for process plant remains very depressed and it is unlikely that there will be any reasonable alternative to closing these operations. All this is a far cry from the heady expansion of the 1970s through the merger of two large metal working and heavy equipment groups with major interests in special steels, shipbuilding and machine tools.

In 1972, it joined up with Westinghouse of the U.S. to create Framatome, a company that would be the sole contractor for building nuclear power plants in France.

That privileged position was threatened in 1973 when the Belgian Empain-Schneider group raised its

holding in Creusot to 34 per cent.

For a while, it looked as if this foreign ownership might compromise the "future" of Framatome's French government contracts. Creusot's rival, General Electric, proposed carrying out the nuclear programme in partnership with General Electric of the U.S. However, the matter was resolved when France's atomic energy agency took a stake in Framatome, enabling it to make sure the company was working in line with the state's wishes.

By 1975, Framatome had orders for nearly FF 7bn, as France's nuclear programme picked up speed, and contracts worth over \$2bn were won in Iran. Creusot group

reached FF 10.6bn in 1977 compared with FF 2.6bn in 1970.

Meanwhile, Creusot as a whole was also growing rapidly. Group sales rose to FF 10.6bn in 1977 compared with FF 2.6bn in 1970. An international expansion programme was underway and the group bought a small U.S. steel company in 1973 and then Phoenix Steel, a U.S. tubemaker, in 1975.

Things started to go wrong in 1978, mainly because of the recession hitting the steel industry, and the group lost FF 1.8bn after breaking even the previous year. Ever since, the group has been struggling to rationalise its steelmaking activities.

Ian Rodger

No regrets over the Bristol

The hotel business hates what it calls "regretting." In layman's terms that is when managers have to regretfully turn down bookings because there is no room at their inns. It has been happening all too frequently in London recently as demand for hotel rooms has soared with the strong U.S. dollar and some rays of economic sunshine over Europe.

David Woodward, aged 35, the head of operations for Holiday Inn in Europe (he runs 62 hotels from his Chelsea office) says the emergence of regular "regretting" is a prime reason why his group has paid £5m to Trafalgar House for the Bristol Hotel in Piccadilly. Holiday Inn badly needs the extra accommodation: the Bristol will give it—nearly 200 bedrooms in the upper end of the four-star bracket in central London. Woodward is starting a crash refurbishment programme while the ink is still wet on the legal documents. He expects to spend £1m on the Bristol this summer converting bedrooms to Holiday Inn specifications.

Woodward's booking managers have had to turn away about £50,000 worth of London business a month recently because the 700 rooms in the group's existing inner London hotels have been insufficient to meet demand. The average rate for a single bed for one night in a four-star London hotel is now between £48 and £55 a night. But the price level is not deterring American visitors.

Amateurs out

The staff of the Observer is being stretched as it tries to monitor developments concerning two races important to that newspaper—as well as getting on with reporting other news of the week. The race to be the next Observer proprietor—Will Robert Maxwell win; will Tiny Rowland sell up? is being run in parallel with late preparations for the 1984

Men and Matters

Observer singlehanded transatlantic race, which starts from Plymouth on June 2 for the usual Newport, Rhode Island, finishing line. The common thread in the two events is the rise of commercialism. Owing to the Observer clearly is not a pastime for an amateur these days. And the same can be said for racing across the Atlantic under sail.

Indeed, the Observer promo-



"I suppose there's no hope of Robert Maxwell paying my Sue?"

Credit Agricole is being sponsored through a three-year racing campaign by the bank to the tune of FF 4m.

The French look upon the Observer race as the Grand National of sailing—all their boats in class one (the biggest boats) are sponsored and the jockeys are only interested in winning. Among the British some competitors are taking part for the gentlemanly reason that, frankly, they enjoy it, although they have no hope of winning.

Safe forecast

Nationalised French companies these days are spared the sometimes painful business of giving financial forecasts to critical inquirers.

At a financial analysts' meeting in Paris this week Loik Le Flech-Prigent, chairman of the chemicals group Rhone-Poulenc, was asked what would be the company's profits for 1984.

He responded with this less-than-illuminating but entirely logical reply, "If the first quarter trends continue then the result for the year will probably be in line with the first three months."

Britannia factor

Life on the ocean wave is proving highly agreeable to Britain's traders in "invisibles."

New business worth some £300m has been identified since members of the British Invisible Exports Council laid on a seminar and a one-day cruise for 80 business guests in the Royal Yacht Britannia off Stockholm last spring, during a royal visit to Sweden. The invisibles men—represent-

ing banking, insurance, financial services, and technical services—first boarded the royal yacht when the Queen and the Duke of Edinburgh visited Italy four years ago.

Partial business to result from contacts made on that day trip off Naples was later calculated to be worth more than \$500m.

Now the council believes that the final figure for business struck with the Britannia, sailed off Stockholm will be far higher. It will include several Anglo-Swedish co-operation deals to finance projects in developing countries, banking co-management arrangements, and deals to assist Swedish industry and commerce with British financial expertise.

William Clarke, director general of the British Invisible Exports Council, is understandably pleased that so much business has come from a few hours at sea—and they were calm seas. He hopes the palace will extend further help to the City: "We do hope that the use of the royal yacht in this discreet way will be a regular feature. She is ideal for the purpose."

Britannia has never served in her secondary role as a hospital ship. And I don't suppose her designers ever thought she would be a success as a bank parlour in her old age.

Travel insurance

Conversation in Japan—a booklet issued by a New York travel agent to help its clients—is determined that they should get the best, as the following extracts show. "My name is — and I have booked a room... Don't you have anything cheaper/better?"

"Please give me a cleaner room... There is no hot water."

"Please show me all the bills I have signed... This is not mine."

Finally, "Please refer me to some other hotel..."

Observer

FULL

22%

GRANTS

For qualifying businesses

SKELMERSDALE

There are still some small, medium and large factories available. And some incredible bargains.

First class, skilled, trained and trainable labour.

Come to Skelmersdale Development Corporation. Speak to John Leigh, Industrial Development Officer, Pennylands, Skelmersdale, Lancs, WN8 8AP. Telephone 0524 32123.

Skelmersdale Development Corporation

SIKH EXTREMISM

'Violence is morally right'

By John Elliott in Amritsar

IN THE same village of Lapokes, near Amritsar, 30-year-old Sumeet Singh, a left-wing writer and member of a well-known Sikh family, was pulled from his scooter and machine-gunned to death by Sikh terrorists because he looked like a Hindu, having tied his turban, and cut his hair.

In Delhi Mr Ranjna Singh, a prominent Sikh industrialist, is heavily guarded on the advice of the Government. He argued on Indian television for Sikh-Hindu harmony, since both groups are primarily Indian. He said two of his sons have cut their hair and his daughter has married a Hindu. He immediately received threats to his life.

Events like these have become common in the north of India in the past few months as the pace and intensity of Sikh terrorism and violence has escalated into possibly the most terrifying and intractable of the many volatile sectarian and religious disturbances that regularly break out in India.

Mrs Gandhi risks losing support among Hindus

city of Sikh terrorism and violence has escalated into possibly the most terrifying and intractable of the many volatile sectarian and religious disturbances that regularly break out in India. So far Mrs Gandhi's Government has failed to act effectively, presumably hoping that, as often happens in India, the problem would solve itself once enough blood has been spilt. The Punjab police are demoralised, intelligence reports are inadequate and the Government refuses to send para-military troops into the Amritsar Golden Temple headquarters of the Sikhs for fear of the violence that would erupt. Nor has it yet had the confidence to produce a peace formula—two of its initiatives in the past two months having literally been blown up by terrorist violence. A long-running campaign by Sikhs for religious recognition and for more autonomy in the home state of the Punjab has been turned into a fervent religious movement which does not tolerate deviation from a strict code. Its tactic is to spread terror among Hindus—including death threats to the Prime Minister, Mrs Indira Gandhi, and her son Rajiv—and among moderate Sikhs.

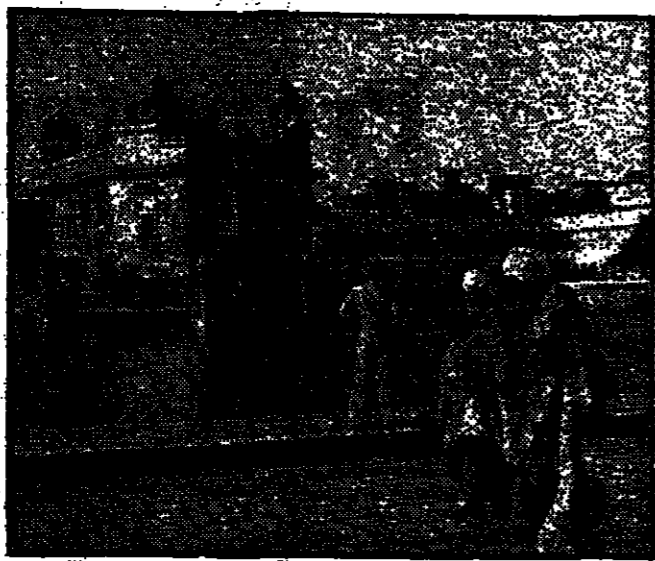

The Golden Temple, Amritsar

More than 180 people have been killed in the past five months. Mr Madan Mohan Wail, Secretary of the Delhi Home Ministry, estimates that it will take up to two months to "break the backs" of the 400 to 500 hardcore terrorists. The question being asked in Amritsar is whether the Government can afford to take that long.

"These are Sikh warriors historically trained to take revenge. Violence for Sikhs is morally right," says Dr Subramaniam Swamy, a leading opposition politician who visited the Golden Temple this week. "Sikhs never give up and once these people really get radicalised there'll be endless trouble."

Outside the temple a series of cheap tape cassettes are on sale made by Sant Jarnal Singh Bhindranwale, the 37-year-old village priest who has become the militant leader. "Everyone should have a gun, a pistol, and 200 grenades and don't bother with a licence," is the tapes' message in the Punjabi language.

Asked if he organised the killings, Bhindranwale replies, "I organised for justice—you can draw your own conclusions." He speaks sitting on the roof of one of the buildings in the Golden Temple, wearing a pistol and dagger and surrounded by heavily armed Nihang Sikhs, the sect's warrior class. Mrs Gandhi's failure so far

to grapple with Bhindranwale and his followers who are general law-breakers who are cashing in on the disorder to loot and kill is a major setback only eight months before the deadline for the country's next general election. The international image she has cultivated as the powerful leader of one of the world's largest countries is bruised. More important, she risks losing support among Hindus who make up over 80 per cent of the population.

The Sikh demands are one example of a key issue she has never wanted to tackle—devolving more power from Delhi to India's 25 major provincial states. Her determination to pull all strings from the centre has helped to increase regional pressure from opposition parties like the Sikh's Akali Dal party in Punjab, various parties that have won elections in the south, the Communists that rule West Bengal, and various pressure groups in Assam. Mrs Gandhi's other major trouble spot.

These pressures and outbreaks of violence often make Indian unity seem fragile to outsiders. In fact the unity is not threatened. As long as regional pressures are dealt with, there is no significant group in the country threatening to break free totally away. Even Bhindranwale who proclaims what are separatist demands says: "We want to live in India—let the central government decide



whether they want to keep us." The Sikh problem is especially significant politically because Punjab borders Pakistan, with which India is constantly at odds. Mrs Gandhi has been trying to deflect criticism by blaming Pakistan for aiding the Sikhs. Pakistan denies this, but people living near the border are sure that guns and ammunition are smuggled into India. Local people have noticed that well-known smugglers have recently started dressing as Nihang Sikhs.

Elsewhere along India's borders Mrs Gandhi has so many problems that political observers wonder whether she will assert herself with some major initiative—a snap election or a change in the constitution to allow her to become a powerful president. Her aides deny this and she said this week: "I wonder which government can go before the people with an issue of violence."

On the border with Bangladesh, clashes have broken out in the past few days as India has started building a barbed wire fence to keep Bangladeshis out of the troubled state of Assam. In the south, Sri Lanka is accused of harbouring its Tamil terrorists and 13 people were killed last Sunday when a Sri Lankan naval patrol opened fire on an Indian boat in the straits between the two countries. Mrs Gandhi can do so much to influence the pace of many of these troubles. If

she were suddenly to try to reassert her authority now in some major political move, there are those in India who would suspect her of having had one eye on this possibility all the time.

There are signs, however, that she is preparing an initiative on the Sikh demands which broadly fall into three categories. First there are religious demands which the Government has started to meet, such as Sikh prayers being broadcast on All India radio and Sikhs being allowed to carry their small daggers—called kirpans—on internal Indian Airlines flights.

Second there are economic matters which can also be met with the agreement of other states and if the Government has the will. They include making the city of Chandigarh the capital only of the Punjab, ending an arrangement where it is shared with the neighbouring state of Haryana. Demands for sharing the waters of the River Indus and sorting out other border differences are also soluble.

Dr Subramaniam Swamy, after his stay this week in the Golden Temple, believes the Government should not get embroiled in any more negotiations which only spark terrorist violence. Instead it should announce a settlement covering the religious and regional issues plus implementation of the Government's offer to change Section 25 of the constitution so that Sikhs are identified separately from Hindus.

This, however, would leave unresolved the third issue which concerns relations between Delhi and individual states. With varying degrees of determination both Bhindranwale and Harchand Singh Longowal, the more moderate but less powerful president of the Akali Dal, say that the Punjab must have provincial autonomy apart from foreign policy, defence, currency and communications. They both said this week that without this no settlement was possible.

Mrs Gandhi, however, would not want to concede anything on this, arguing that she should wait for a report on what are called centre-state relations in general from a commission studying the subject. It is for this reason that politicians like Swamy say a package of concessions in other regional and religious issues should be

announced. They hope that this would win such country-wide support that, coupled with strong security action against the terrorists, violence would have to stop.

Lawlessness in the Punjab and especially in Amritsar and neighbouring areas, has, however, reached such a level that it might not be so easily stopped.

The deaths and violence have involved not only clashes between Sikhs and police, and Sikhs and Hindus, but Sikh terrorism against moderate Sikhs and against Nirankaris, a non-fundamentalist group attractive to Hindus. Nearly 40 countryside railway stations were set on fire earlier this month by Sikh students protesting against a ban on their union. Some students have formed themselves into a new terrorist movement called the Deshmeh regiment after an

The economy of the Punjab is suffering

early Sikh guru and the Government admits it has rounded up only a handful of the ring-leaders in 330 student arrests.

In Amritsar students and other Sikh youths rob houses and the Hindu owners are too scared to complain to the police.

This week near Amritsar I saw a blood splattered entrance hall of a house where a 37-year-old air force squadron leader was backed to death across the back of his neck last weekend by Sikh thieves. People in their homes jerk nervously when they hear the sound of a motorbike, the terrorists' favourite mode of transport.

The Punjab economy is suffering which is potentially serious because it contains India's richest farmland and is a seedbed for new businessmen. New investment in textiles and light engineering by Hindus is drying up and companies are expanding in neighbouring states instead. Companies report that buyers, salesmen and other visitors such as maintenance engineers are refusing to enter the state.

All this points up severity of the challenge facing Mrs Gandhi.

Lombard Private jobs for public servants

By Robin Pauley

FOR EVERY Permanent Secretary that retires at 60 to tidy up the rose garden, another plucks the choicest blooms from a spray of lucrative company directorships. There is nothing very wrong about that and only occasionally any disquiet.

Nevertheless, there is a legitimate public and national interest in the transfer of senior public employees, privy to the most sensitive and secret affairs of state, to the private sector for large fees which could, conceivably, be construed as payments for contractually useful insider information.

There is, therefore, much to commend the inquiry currently being undertaken by a small sub-committee of the Treasury and Civil Service Select Committee into the acceptance of outside appointments by Crown servants. The fact that it comes only three years after a similar inquiry, shows that there is continuing concern, at least in Parliament, about this subject.

It is concern based not so much on the notion that there is widespread corruption afoot, but rather that, as in the case of audit or the judiciary, the system must not only be right and proper but must be clearly seen to be so.

There are already a number of rules covering the movement of members of the Civil Service armed forces and diplomatic service to the private sector. Since 1975 an advisory committee under the chairmanship of Lord Diamond has vetted applications from Permanent Secretaries and their equivalents, referred to it by the head of the Civil Service and the Prime Minister.

The Permanent Secretaries themselves, in consultation with their ministers and the head of the Civil Service, have been responsible for scrutinising applications of more junior civil servants within their departments.

To take Permanent Secretaries first, there is no inherent reason why people at the top of their chosen professions should suddenly be regarded as having nothing further to offer at the age of 60. There is, however, every reason to support 60, or younger, as the statutory senior Civil Service retirement age.

There is already a log-jam of mid-career, mid-rank talent whose promotion prospects are effectively blocked. Everything that can be done to free this jam, including some of the schemes for early full-pension retirement and public-private sector career exchanges, which work so effectively in countries such as Canada, should be considered urgently. This could form the basis of an equally useful inquiry by this select committee.

Permanent Secretaries are often a combination of departmental generalists and ministerial right-hand men (or hand holders) — the interface between Government and administration.

For them, the present rules and arrangements appear broadly satisfactory—although it might be wise to insist that every Permanent Secretary taking up employment within two years of retiring appear personally before the Diamond Committee, and that the composition of that committee be widened to include more people whose principal career has not been within the public service.

A more difficult topic is the movement of civil servants to the private sector in mid-career. Mid-rank civil servants have the detailed knowledge of sensitive negotiations or contractual arrangements and they could be highly desirable catches for companies involved in government contracts. This is at its potentially most sensitive in the area of defence. It is further complicated by the fact that moves by civil servants to companies in this sector could raise issues of public interest which are balanced by considerations of national interest in a field where industrial competition is fierce and largely international.

It might be prudent, therefore, to construct a broader vetting committee for all mid-career transfers from the Defence Department — civil servants, the armed services and research.

The trick is to strike the right balance between safeguarding the public interest in potentially sensitive areas and giving every encouragement to career movement.

Confidence in nuclear energy

From the Company Secretary, British Nuclear Fuels. Sir—I can understand the concern expressed by Mr Stan Dean, president-elect of the Electrical Power Engineers' Association, about the effect of the recent Sellafield incident on the public's confidence in nuclear power. This concerns the company too. However, straightforward comparisons between operations at BNFL's reprocessing plant and the CEBG's nuclear power stations of the kind apparently made by Mr Dean are misleading, because of the very different activities involved. It is not surprising that radiation exposure levels to staff are higher in the reprocessing plant than in individual nuclear power stations, as 99 per cent of the radioactivity remaining from all UK nuclear power operations ends up at Sellafield in the spent nuclear fuel sent there for reprocessing. In fact, occupational exposures at Sellafield have declined steadily.

A more appropriate comparison is that between the CEBG's nuclear power stations and the two Magnox power stations which BNFL operates, Calder Hall and Chapelcross. The standards of safety maintained at these two stations for more than 25 years are the highest order, as borne out by the award to Chapelcross on three separate occasions of the British Safety Council's Sword of Excellence. H. E. Bolter, British Nuclear Fuels, Risley, Warrington.

Accounting for inflation

From Mr M. Wilkins. Sir—The Finance Director of GRN has questioned the usefulness of publicly accounting for inflation (April 10), noting Mr Lawson's comments on the reduction in the rate of inflation. However, it is not clear to me why he considers that investors and other users of published accounts should be deprived of this information, when he admits that it is necessary to recognise the effects of inflation in managing a business. I note from GRN's recent annual report that group earnings calculations under the two alternative bases were as follows:

Table with 2 columns: Year (1983, 1982), Historical cost (£m), and Inflation-adjusted (£m). Values: 1983: 35.0, 16; 1982: 38.0, 22.

Such differences can hardly be described as immaterial. In my view it is the current cost results which give a clearer picture of the performance of the business.

Who is interested in the historical cost of the house they bought 10 or 20 years ago? The most useful figure is the current

Letters to the Editor

cost or value today, and this must surely also be the case in business. Although inflation is now "only" around 5 per cent, many, if not most, businesses are still using assets brought 10 or 20 years ago, and the original cost of these assets is of little relevance in assessing the performance of the business today. Prices in the UK have more than trebled in the past 10 years and even at 5 per cent per annum prices would increase by over 60 per cent in 10 years.

I hope, therefore, that whatever form SSAP 18 takes, listed and other publicly accountable companies will indeed account publicly for the effects of inflation on their business. R. M. Williams, 5, Colmore Gardens, Highcliffe, Christchurch, Dorset.

Small drug groups under threat

From the Managing Director, Hoechst UK. Sir—I read Carla Rapoport's article "Small drug groups under threat" (April 24) with interest. While much of what she says may be correct, one of the main problems in pharmaceutical research and development is the reduction of effective patent-life to approximately eight years and a continuing trend towards further shortening.

Under such circumstances there is less and less motivation to undertake R and D at all, and certainly almost none to go for brand-new areas, where the risks are higher, the development time longer and the chances of recovering investment costs more or less zero. However, if the patent life was restored to start with the product licence (even if this was somewhat shorter than the full 20 years), the incentive to research in novel fields would be restored and your quote from the Jordan report would be true.

I feel this patent-erosion problem is basic to the future of real advances in therapeutic agents and has so far been largely ignored. Brian W. Grunla, Hoechst House, Salisbury Road, Hounslow, Middx.

Power engineers and privatisation

From The Deputy General Secretary, Electrical Power Engineers Association. Sir—In your issue of April 19 the headline on an article reporting the proceedings at the Electrical Power Engineers'

Association's Conference read "Power plant engineers warn of action to halt privatisation."

There was a very long debate on this subject and it was overwhelmingly concerned with the arguments to be used in bringing to the attention of the Government, Parliament and the electricity consumers the serious damage which the association believe denationalisation of the electricity supply industry might cause. In the course of the debate the question was asked whether the association would take industrial action over this issue, to which the reply was given that this possibility had not been ruled out. It seems unfortunate that this small part of the debate became the focus of the report through your choice of headline.

On one further point the report describes the EPEA's members as having kept power stations going when all other unions in the industry have been on strike. I can recall no occasion when all other unions in the industry have been on strike.

The last occasion on which EPEA members kept power stations running when strike action was being taken by other staff was when unofficial action was being taken by certain National Joint Industrial Council members against their own trade unions. Under those circumstances it seemed right to the association's members that the engineers and managers who run the power stations should have kept them going.

Simon Fitch, Deputy General Secretary, EPEA, Station House, Fox Lane North, Chertsey, Surrey.

Miners' strike ballots

From Mr C. J. Carter. Sir—In his article (April 24) on the inevitability of coal strikes, Philip Basset does not point out what was to me the most interesting aspect of the record of voting in nine strike ballots.

In none of these ballots did the voting for a strike yield a Yes vote between 50 per cent and 55 per cent, so in none of these ballots would strike action have been affected by the recent reduction to 50 per cent + one in the requirement for strike action.

C. J. Carter, Flat 18, Gorsland Court, Gleamwood Road, Ferndown, Dorset.

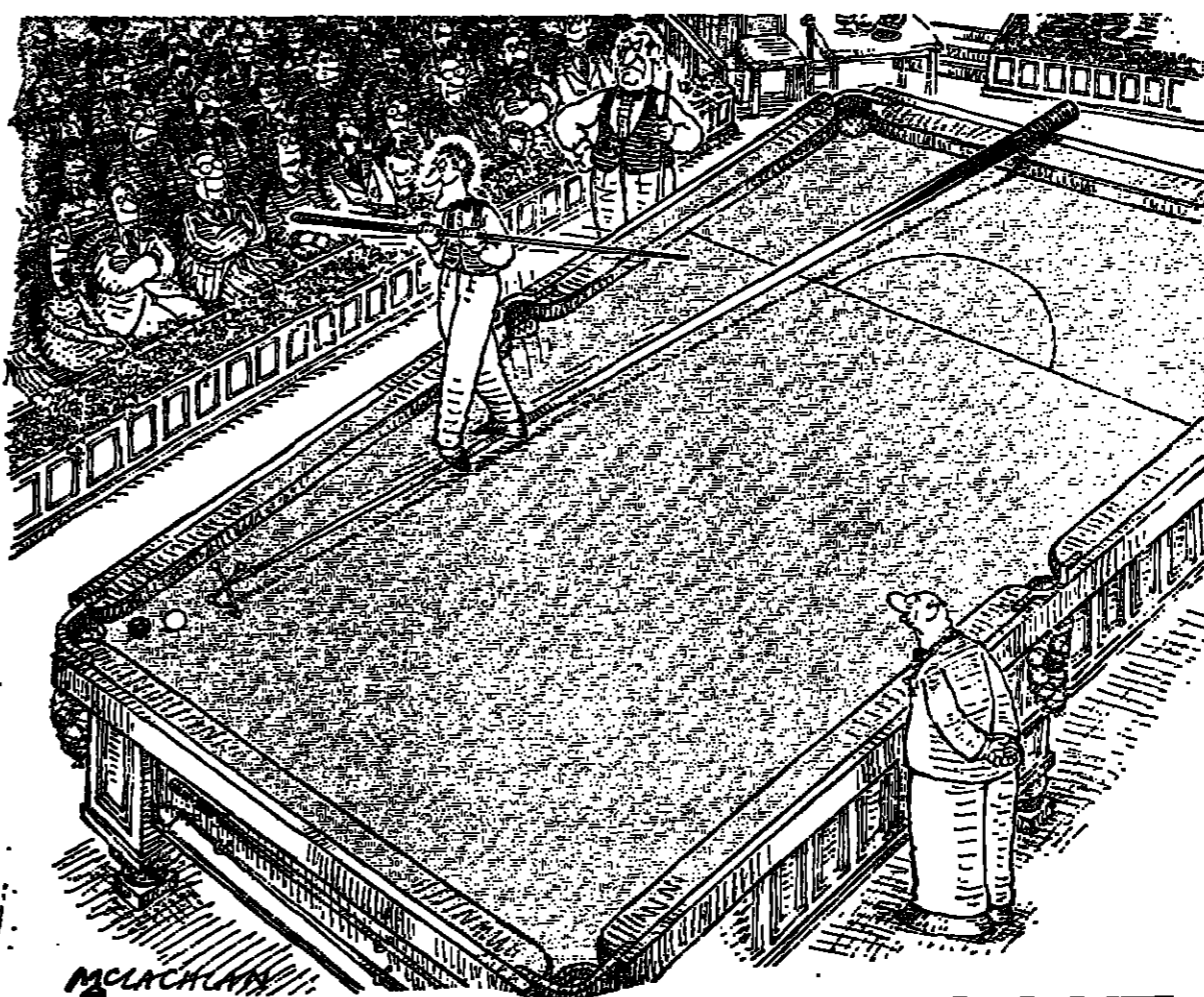

GET IN TOUCH AND WE'LL PUT YOU AT THE FRONT OF THE QUEUE.

Don't let our name mislead you. While we're closely involved with leading companies trading between Britain and Scandinavia, as a UK bank, we are also a major source of finance and investment for British companies in the UK and internationally.

In fact, Scandinavian Bank is one of Britain's top twenty banks with assets well in excess of £2½ billion and offices in fourteen financial centres worldwide.

But there is a very Scandinavian aspect in the way we run our Bank. We are totally committed to customer service. This is reflected in everything we do and goes a long way towards explaining the

Bank's rapid growth since it was founded in 1969. Scandinavian Bank provides its customers with the support and expertise they need in today's competitive world. Red tape is kept to a minimum and the fast response you need is always given.

We work alongside our customers to create innovative financial packages to meet their particular needs.

So, if you're looking for a special service in trade finance, leasing, foreign exchange or any other area of U.K. or international business, call us.

You'll soon discover the advantages of being at the front of the queue.



Service so good it puts you in the lead.

Scandinavian Bank Limited, 2-6 Cannon Street, London EC4M 6GX. Tel: 01 236 6090. Customer Services Manager. Extension 346. Telex: 889093. International Offices: Bahrain, Bermuda, Geneva, Hong Kong, Los Angeles, Madrid, Milan, Monaco, New York, Sao Paulo, Singapore, Sydney, Tokyo, Zurich.

**Company Cars
are our business.**

Godfrey Davis
Contract Hire

Phone Graham Darley on 01-950 8135

**BELL'S
SCOTCH WHISKY
BELL'S**

Ruling threatens Austrian banking secrecy

By Our Vienna Correspondent

AUSTRIAN banking secrecy has come under threat after a court decision. The High Administrative Court has altered rules to give tax inspectors greater access to information from businesses and banks.

The decision has caused concern among financial institutions which claim it sets a precedent that could undermine the principle of banking secrecy.

The controversy has been generated by the court's dismissal of a claim by a small rural co-operative bank that a tax inspector had exceeded his rights by taking documents from the bank which did not relate to initial inquiries.

The court found against the bank and argued that the inspector's action in taking an individual's file, unconnected with preliminary inquiries, was legitimate as he had grounds for suspicion that a tax offence may have been committed.

In these circumstances, the court argued, the inspector was not bound by the law which protects a bank's customers.

Dr Hans Haumer, chairman of the Saving Banks' Association, described the decision as "extremely dangerous" and called on the Austrian Government to protect banking secrecy. "How do you define suspicion? If someone has half a million on schillings in a savings book does this automatically mean he isn't paying taxes?" he asked.

Banking secrecy in Austria is protected by civil and criminal law. Under article 23 of the Credit Law, credit institutions and their staff must not "disclose or make use of any secrets entrusted to them exclusively in the context of business relations with their customers."

A banker or employee risks heavy fines and up to a year in prison for disclosing information protected by the law.

The law also protects anonymity. Numbered or anonymous accounts are allowed and widely used. However, unlike in Switzerland, where the name of the client or another beneficiary must be given to the bank, this is not required.

This difference gives rise to the claim by some people that banking secrecy in Austria is tighter than in Switzerland, where the subject is also under special scrutiny at the moment. The Swiss go to the polls on May 20 to vote on proposals to reduce banking secrecy.

Sweden offers novel \$800m U.S. issue

Continued from Page 1

Sweden is guaranteed its money for seven years, and investors are happy because they can redeem the bonds after one year. As Mr Peter Engstrom, director of the Swedish National Debt Office, said yesterday, "We are getting a larger note issue at a lower cost than could be done on a normal seven-year maturity. And it is a lot cheaper than any purely bank-based financing."

Sweden is noted for its innovative approach to external financing. Last year it launched what at the time was the largest ever Eurobond, in November, the first Eurobond issuer to double the size of a deal; and this March, it issued a 40-year bond at a time when the longest maturity was only 20 years.

This FRN will have its terms fixed on May 2, but the indicated coupon is either 7/8 percentage points under the U.S. prime rate or 3/4 points over the rate for three-month "unadjusted" certificates of deposit, whichever is lower. Salomon described the initial investor response as "quite overwhelming."

World Weather

Location	Temp	Wind	Cloud	Temp	Wind	Cloud
London	15	10	Partly	15	10	Partly
Paris	14	12	Partly	14	12	Partly
Rome	18	15	Partly	18	15	Partly
Madrid	16	10	Partly	16	10	Partly
Amsterdam	13	10	Partly	13	10	Partly
Brussels	13	10	Partly	13	10	Partly
Frankfurt	14	10	Partly	14	10	Partly
Munich	15	10	Partly	15	10	Partly
Stockholm	12	10	Partly	12	10	Partly
Helsinki	11	10	Partly	11	10	Partly
Oslo	10	10	Partly	10	10	Partly
Warsaw	13	10	Partly	13	10	Partly
Berlin	14	10	Partly	14	10	Partly
Vienna	15	10	Partly	15	10	Partly
Zurich	14	10	Partly	14	10	Partly
Geneva	14	10	Partly	14	10	Partly
Basel	14	10	Partly	14	10	Partly
Brno	15	10	Partly	15	10	Partly
Prague	15	10	Partly	15	10	Partly
Warsaw	15	10	Partly	15	10	Partly
Budapest	16	10	Partly	16	10	Partly
Belgrade	16	10	Partly	16	10	Partly
Sofia	17	10	Partly	17	10	Partly
Thessalonika	18	10	Partly	18	10	Partly
Atenas	19	10	Partly	19	10	Partly
Nicosia	20	10	Partly	20	10	Partly
Jerusalem	18	10	Partly	18	10	Partly
Tel Aviv	19	10	Partly	19	10	Partly
Beirut	18	10	Partly	18	10	Partly
Damascus	17	10	Partly	17	10	Partly
Baghdad	16	10	Partly	16	10	Partly
Tripoli	15	10	Partly	15	10	Partly
Cairo	14	10	Partly	14	10	Partly
Alexandria	13	10	Partly	13	10	Partly
Algiers	12	10	Partly	12	10	Partly
Tunis	11	10	Partly	11	10	Partly
Madrid	16	10	Partly	16	10	Partly
Barcelona	17	10	Partly	17	10	Partly
Valencia	18	10	Partly	18	10	Partly
Seville	19	10	Partly	19	10	Partly
Malaga	20	10	Partly	20	10	Partly
London	15	10	Partly	15	10	Partly
Paris	14	12	Partly	14	12	Partly
Rome	18	15	Partly	18	15	Partly
Madrid	16	10	Partly	16	10	Partly
Amsterdam	13	10	Partly	13	10	Partly
Brussels	13	10	Partly	13	10	Partly
Frankfurt	14	10	Partly	14	10	Partly
Munich	15	10	Partly	15	10	Partly
Stockholm	12	10	Partly	12	10	Partly
Helsinki	11	10	Partly	11	10	Partly
Oslo	10	10	Partly	10	10	Partly
Warsaw	13	10	Partly	13	10	Partly
Berlin	14	10	Partly	14	10	Partly
Vienna	15	10	Partly	15	10	Partly
Zurich	14	10	Partly	14	10	Partly
Geneva	14	10	Partly	14	10	Partly
Basel	14	10	Partly	14	10	Partly
Brno	15	10	Partly	15	10	Partly
Prague	15	10	Partly	15	10	Partly
Warsaw	15	10	Partly	15	10	Partly
Budapest	16	10	Partly	16	10	Partly
Belgrade	16	10	Partly	16	10	Partly
Sofia	17	10	Partly	17	10	Partly
Thessalonika	18	10	Partly	18	10	Partly
Atenas	19	10	Partly	19	10	Partly
Nicosia	20	10	Partly	20	10	Partly
Jerusalem	18	10	Partly	18	10	Partly
Tel Aviv	19	10	Partly	19	10	Partly
Beirut	18	10	Partly	18	10	Partly
Damascus	17	10	Partly	17	10	Partly
Baghdad	16	10	Partly	16	10	Partly
Tripoli	15	10	Partly	15	10	Partly
Cairo	14	10	Partly	14	10	Partly
Alexandria	13	10	Partly	13	10	Partly
Algiers	12	10	Partly	12	10	Partly
Tunis	11	10	Partly	11	10	Partly

China and U.S. agree nuclear power deal

BY MARK BAKER IN PEKING

CHINA and the U.S. have agreed on a nuclear co-operation pact that will enable U.S. companies to share in an estimated \$20bn worth of contracts to develop China's nuclear power industry.

The agreement was reached only after a last-minute scramble to have it concluded during President Ronald Reagan's visit to China, which began yesterday. It will be signed on Monday by Mr Arthur Hummel, U.S. Ambassador to China, in the presence of Mr Reagan and Zhao Ziyang, the Chinese Premier.

The major sticking point was believed to have been China's reluctance to allow U.S. inspections of its nuclear industry, and it was not clear last night how the issue was resolved.

A senior U.S. official said, however, that the agreement called for "exchanges of information, regular consultations and visits" which would provide "the additional assurances we need that U.S.-supplied materials and facilities are being used solely for peaceful purposes."

The agreement would provide "the legal framework" for the sale of nuclear reactors, components, nuclear materials and technology but it was "not a commitment to supply nuclear reactors or materi-

als. Rather it is a framework agreement which specifies the guarantees and controls under which supply may take place." There would be no transfer of sensitive nuclear technology or facilities such as reprocessing and enrichment plants.

China, which recently joined the International Atomic Energy Agency to mollify U.S. congressional opposition to the deal, plans to build nuclear power plants with a combined generating capacity of 10,000 megawatts by the end of the century. Its first plant, with a capacity of 1,800 megawatts, is to be built at Daya Bay, near Hong Kong, at an estimated cost of \$5bn, with French and British participation.

Japan signed a nuclear co-operation agreement with the Chinese last month and the West Germans are expected to sign one next month.

U.S. officials said any sale of reactors, components and technology would be a commercial matter that would be negotiated between U.S. companies and China. Individual reactors would have to be licensed by the U.S. nuclear regulatory commission. The agreement contained provisions that are required for deals with nuclear weapon states under the U.S. Atomic Energy Act, particularly those ensuring

that sales by the U.S. of nuclear material are for peaceful purposes.

Mr Reagan, who will spend six days in China, was welcomed with a 21-gun salute, the first in China since the Cultural Revolution in the late 1960s.

The President and Mrs Reagan arrived from Guam aboard Air Force One and were greeted by Wu Xueqian, the Chinese Foreign Minister and a crowd of wolf-whistling, flag-waving U.S. residents, shivering in icy cold weather which had moved in from Mongolia earlier in the day.

The presidential party was driven to Peking's central Tiananmen Square, where Mr Reagan shivered in his lounge suit as the gun salute thundered across the city.

For Peking, the visit brought the toughest security measures seen for a foreign dignitary.

Sir Edward Youde, the Governor of Hong Kong, left for Peking yesterday for a further round of talks on the future of the British colony, reports AP from Hong Kong. The two-day meeting, which starts today, will be the first between the two countries since the UK's formal announcement that it will relinquish sovereignty over the territory in 1997.

China satellite plan, Page 8

ICI sees recovery as profits surge to £245m in quarter

BY CARLA RAPAPORT IN LONDON

IMPERIAL CHEMICAL Industries (ICI) yesterday reported a near doubling of its first-quarter pre-tax profits as a result of higher prices and better sales volumes in its chemicals, fibres and plastics businesses.

All the divisions of Britain's largest chemical company are making profits for the first time since 1974.

Laporte, another major UK chemical company, also announced sharply improved profits yesterday.

The group reported pre-tax profits of £245m (\$345.6m) on sales of £2.37bn in the first quarter of 1984, compared with £126m on sales of £2.02bn in the same quarter last year.

These results comfortably exceeded analysts' forecasts and ICI's shares closed at 620p, up 14p.

"Not only was the City pleased, so were we," said Mr Alan Clements, ICI's finance director. "There has been no indication of deterioration in any of our markets. We are seeing the effects of a steady, sustained recovery worldwide."

ICI has continued to boost prices for its major products, achieving another 2 per cent gain in sales volumes and prices in the first quarter of 1984 compared with the fourth quarter of last year.

The company has remained cautious, however, about the strength of this recovery. In the past few months, a number of top executives have questioned whether it would last until the end of 1984 for high-volume commodity plastics.

Yesterday's unexpectedly good result has tempered some of this

caution. "I would say that the size of the improvement has surprised some of our gloomier people," said Mr Clements.

Financial analysts yesterday said they had upgraded their forecasts for ICI's full-year results to between £550 and £560m pre-tax. ICI has said it will restore its dividend to the 1979 level in real terms if the group reaches pre-tax profits of £1bn.

Laporte profits before tax climbed to £30.2m, from £20.1m in 1982, on sales which advanced from £241m to £290m.

The improvement, according to Laporte, was due in large part to the strong recovery of the group's titanium dioxide business. It recently agreed to sell this division to SCM of the U.S. for about \$85m.

Gulf tanker ablaze

BY RICHARD JOHNS IN LONDON

A PREDOMINANTLY Saudi Arabian-owned super-tanker, the Safina el-Arab, was still on fire last night about 100 miles south of Kharg Island, the main Iranian oil terminal, where it lifted 357,000 tonnes of crude earlier this week.

The Institute of London Underwriters war risk committee met yesterday but it is understood not to have confirmed that the vessel was a war casualty. It left premiums unchanged, brokers said. The cargo is understood to be insured for \$71.4m.

Iraq did not claim to have hit the vessel. The extent of the damage suggested that it had not been hit by an Exocet missile, but survivors were quoted by the captain of a salvage vessel as saying that the explosion appeared to have been caused by a "projectile".

All but one of the Safina el-Arab's crew were rescued. Last night, the Dutch salvage company Samit International said that flames in the tanker's aft cabin and accommodation quarters had died down. The vessel was under tow having been set on fire 70 miles south of Kharg Island.

The Safina el-Arab is Saudi-registered. It is 56 per cent owned by the Safina company in which a leading shareholder is Prince Feisal bin Fahd, a son King Fahd of Saudi Arabia, and 44 per cent by Selen Tankers of Sweden which operates the vessel.

It was reported that Iraq aircraft had been strafing in the vicinity of Kharg Island early on Wednesday

Delta and UAL sharply higher

By Paul Taylor in New York

TWO OF the major U.S. domestic airlines, UAL and Delta, yesterday reported sharply higher quarterly earnings.

UAL, the holding company for United Airlines which is the largest U.S. domestic carrier, reported first-quarter earnings of \$25.8m, or 56 cents a share, compared with a \$9.4m or \$3.13 loss in the 1983 equivalent.

Delta Airlines, the sixth largest U.S. carrier, also reported a sharp increase in its fiscal third-quarter earnings bolstered by a \$39.5m net gain from the sale of aircraft.

Its net earnings of \$52.8m, or \$1.33 a share in the latest period, compared with a net loss of \$39.5m, or 99 cents a share, in the 1983 fiscal third-quarter.

Telecom issue could be delayed

Continued from Page 1

BT if it chose to repay the debt early.

BT is worried that if its freedom to raise tariffs is too strictly curtailed, it could have difficulty in servicing the debt and preference shares, paying dividends to ordinary shareholders and financing its £2bn a year capital investment programme.

BT's short-term financial position has been made worse by the UK budget, which it expects sharply to increase its tax bill in the next five years. To meet this problem the Treasury has offered a five-year moratorium on BT's debt repayments.

The Government is close to selecting an adviser to help sell BT shares in Japan. Early next week it will interview in London representatives of the four leading Japanese securities houses, Nomura, Nikko, Daiwa and Yamachi.

Morgan Stanley, one of the leading Wall Street firms, has already been chosen as advisor on a U.S. sale. But Morgan Stanley has made clear that it can not give a firm opinion until the terms of the flotation are settled.

Mexican state group may return to loan market

By David Gardner in Mexico City

A MEXICAN public sector company is considering returning to the money markets for a syndicated loan of \$100m-\$150m, in the form of bankers' acceptances, to finance the building of sugar warehouses.

No mandate has yet been issued and a decision to go ahead has yet to be taken by the ministry of Finance. Senior Treasury officials are expected to hear the opinion of the international banks in New York this week.

A spokesman for Finasa said the bank's borrowing plans were part of an attempt to "get back to business as usual" with U.S. and European banks. Other public sector companies were also beginning to consider a return to the market.

Since autumn 1982, Mexico has raised over \$16.5bn in new money from commercial banks, the IMF, the Bank for International Settlements and U.S. Government agencies. It has rescheduled \$23bn in public sector debt and devised a scheme to protect private companies from foreign exchange fluctuations on \$11.8bn of their foreign borrowing. It has also renewed trade credit lines and opened new ones.

But despite the remarkable turnaround Mexico has achieved on its external accounts - last year's current account surplus was \$5.5bn against a 1982 deficit of \$4.9bn - and in rebuilding its reserves to a current level of about \$6bn, some bankers and analysts believe it is too soon to approach the market.

Furthermore, it is argued that any attempt to test the waters should be carried out by solidly blue chip corporations like Pemex, the state oil company.

Mexico's strategy, however, is to try and move to a position where the markets will resume "voluntary" lending to it once again, after 18 months of "forced" lending.

Finasa followed an active borrowing programme until 1982. It last went to the markets in 1981 and 1982 for two loans of \$300m and \$250m in syndications led by Wells Fargo.

THE LEX COLUMN Profit retort from ICI

From the beginning of the year the market has been somewhat unwilling to take ICI's recovery at face value, preferring instead to chew upon the question of what may happen to profits after output reaches its cyclical peak - maybe even before the end of 1984. But first-quarter profits of £245m before tax could go a long way to disarm this recent cynicism, apart from encouraging optimists to rebase their four-time tables.

The figures so far are certainly very encouraging, suggesting that the market has generally underestimated the degree to which margins in ICI's more cyclical products are boosted by increasing output. In the first three months of 1984 sales rose by a fairly modest 5 per cent over the last quarter of 1983, but price increases of 2 per cent were probably worth £40m at the pre-tax line, and volume gains of the same order added about another £20m. More relevantly, where prospects are concerned, product markets still appear to be tightening, price increases have tended to stick, and customers seem prepared to build stocks.

The shares jumped 10p yesterday to 620p, a price which could yet come to look rather modest if ICI were indeed to come anywhere near making £1bn - this year or next. The implied multiple of about seven times net earnings perhaps discounts the next recession too severely, almost as if ICI had not eliminated huge parts of the fixed costs which crippled it last time things cut up rough in the chemical markets.

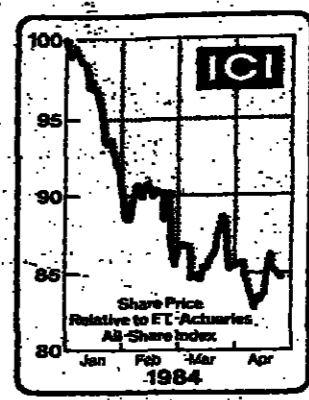

House of Fraser
A preliminary statement from the House of Fraser these days offers few useful clues to the group's future and yesterday's, showing pre-tax profits for 1983 up 25 per cent at £38.6m, was no exception. It gives some idea of the damage inflicted on all Fraser's London stores - about a quarter of its total floor-space - by the Christmas bombings, since trading profits have emerged on this account perhaps £1m to £2m lower than expected. Any shareholders fascinated by the accounting contortions arising from the budget can note their directors' clarity in

shifting a £30.4m deferred tax debt into the body of the p & l, now that a transfer from reserves can legitimately be used to cover the hole in retained earnings. But the figures remain a poor guide to the deeper changes within the group.

The group's £180m refurbishment programme, now in the second of its designated five years, has been accompanied by "more changes in the merchandise mix towards higher margin products. The benefit to gross margins has been largely offset, it seems, by the burden of costs incurred as a result of the longer term strategy; but Fraser is at least laying claim to stronger volume sales than its competitors so far this year.

There are signs, too, that Fraser is fast becoming a more efficient retailer, though evidently not fast enough to please its energetic minority shareholders - Lorrho's directors still see their role on Fraser's board as far removed as ever, one might say, from observer status.

BCI/Wimpey
Developing countries have hardly been happy places for either Blue Circle (BCI) or Wimpey through the recession. BCI's Latin American, Indonesian and black African interests contributed only 11 per cent to group earnings in 1983 compared with 50 per cent in 1981. There is now a determination at BCI to shift parts of the group's base to more stable areas of the world, particularly the U.S., where last year's purchase of three cement plants looks remark-

ably well-timed. Heavy spending in the UK too should bear fruit eventually.

At least the balance sheet damage done to BCI through its Third World involvement is limited this time to an £8m provision against the whole of its Indonesian investment.

Wimpey has come to worse harm through its work in the more exotic parts of the world, with three separate exceptional losses. The £41.7m total was a surprise given the chairman's February forecast of a £35m maximum, but it does make Wimpey's property sales, netting exceptional profits of £42.1m, look judiciously timed. Wimpey does not oblige with a profits breakdown, but overall margins have been cut sharply, while the U.S. business seems to be going better than most.

The outlook for BCI looks clear, if unexciting in 1984. But the picture at Wimpey is murky, apart from a further £17m property profit this year, and the management is offering little guidance. Yesterday's share price moves, BCI up 5p at 430p and Wimpey down 13p at 137p, say it all.

Kingdom of Sweden
As the British Government ponders how to sell debt in the gleaming new London securities market, it might cast an eye over the enterprising financial antics of the Kingdom of Sweden. Only a few months ago Sweden put the longest dated gilt-edged in the shade by issuing floating rate notes with a maturity of 40 years. Now Sweden is refinancing an existing \$800m credit with FRNs which give the country seven year funds broadly at the cost of 12-month money.

This remarkable piece of yield curve dexterity is achieved through a back up facility from commercial banks, which guarantee to substitute loan notes for any FRNs which are surrendered and not resold after one year. In effect, the investor has a security which can be redeemed after one year, while the borrower is assured seven-year cash. The new structure will save Sweden at least 30 basis points on overall funding costs, enough to make Mullens sit up and listen.

Cummins Daventry -World Power

Worldwide, people depend on Cummins power. They depend on Cummins diesel engines to power construction equipment, generator sets, boats, locomotives, trucks and buses.

People depend on Cummins built engines for fuel economy, reliability and durability. Cummins Daventry, who build 900 to 1600 horsepower engines, export to every continent in the world and are supported worldwide by a service and parts network of over 5000 outlets.

1984 is the third year Cummins at Daventry have won the Queens Award for Export Achievement. We thank our employees, suppliers and customers who have made this success possible.

Cummins Engine Company Limited
Royal Oak Way South, Daventry,
Northants NN11 5NU
Tel (05272) 76000

Thomson, Philips in computer talks

Continued from Page 1

entire European personal computer market, Thomson is negotiating a distribution and co-operation agreement with a British company, said M Philippe Vincent, Thomson's microcomputer export manager. The French group has no distribution network in the UK.

In an effort to develop the use of personal computers in French homes, the Socialist Government has followed a "successful British idea to popularise the computer through BBC television programmes by asking TFI, the first channel of the national French tele-

manufacturing plant, St-Pierre Montlaur at Angers, could produce up to 500,000 personal computers a year. The world shortage of semiconductor components, however, was forcing the French group to hold down production this year at around the 100,000 level.

Thomson plans to market the new products outside France from next September. M Gorothwohl estimates the French personal computer market this year at 300,000 units and a similar number for West Germany.

To penetrate the UK market, which accounts for about half of the

vision, to screen a series of computer educational programmes. The programmes will enable viewers to learn and practice on their personal computers while watching the television series. Thomson expects its new personal computers to be chosen by TFI as the computer hardware for the series.

In a further attempt to popularise the personal computer in France, Thomson has fitted a special train with a whole range of home computer electronics and systems. The train will visit seven cities in France to exhibit French personal computer technology.

Self is life

Published by The Financial Times (Europe) Ltd, Frankfurt Branch, represented by G.F.S. Damer, Frankfurt/Main, F. R.G.M., R.A.F. McClean, M.C. Gorman, D.E.P. Palmer, London, as members of the Board of Directors, Printer: Frankfurt Societys-Druckerei GmbH, Frankfurt/Main. Responsible editor: C.E.P. Smith, Frankfurt/Main. © The Financial Times Ltd 1984.



SECTION II - INTERNATIONAL COMPANIES

FINANCIAL TIMES

Friday April 27 1984



Quaker recovers in third quarter

By Terry Byland in New York

THE DISPOSAL of loss-making operations has left Quaker Oats, the grocery and toy group, level pegging in the third quarter of the fiscal year. The board says that this reflects a planned increase of 25 per cent in advertising and marketing costs on U.S. grocery products.

Sales jumped by 25 per cent to \$206.7m. Net earnings of \$26.9m or \$1.29 a share for the third quarter compare with \$26.4m from continuing operations in the same period last year when a \$58m loss from discontinued operations made final net \$31.6m.

At the nine months stage, net earnings of \$89.7m or \$4.33 a share compare with net profit of \$78.2m or \$3.81 a share from continuing operations. A 26 per cent rise has put turnover for the nine months at \$2.4bn.

Earnings have been held back this year by heavy advertising costs which, under new accounting rules, have to be charged against profits. The fiscal year ends on June 30.

Modest rise for U.S. household goods major

By Our New York Staff

PROCTER & Gamble, the U.S. household goods major which is facing increasingly tough competition in many markets, increased its net income in its third quarter ending March by less than 1 per cent from \$218m to \$220m.

The group earned \$1.32 per share in the quarter compared with \$1.31 a year ago. For the first nine months it has earned \$707m or \$4.25 per share - an increase of 2.9 per cent from the \$685m or \$4.13 last time.

U.S. stockbrokers may aid Baldwin investors

BY WILLIAM HALL IN NEW YORK

THE U.S. stockbroking and life insurance industries are discussing contributing up to \$250m to help the 185,000 people who bought over \$4bn of "guaranteed" single premium deferred annuities from the failed Baldwin-United Corporation.

Major U.S. stockbrokers and insurance companies have come under severe criticism for actively promoting Baldwin-United annuities, a form of tax free saving, at a time when the company's financial condition was deteriorating. Major brokers, including household names like Merrill Lynch, E. F. Hutton and Shearson American Express, marketed the product as a "safe" investment, and following the collapse of Baldwin last year they are being sued for "unfair and deceptive" practices.

In an effort to protect their reputations, several leading firms such as Merrill Lynch and Prudential-Bache have announced voluntary plans to aid their customers who bought Baldwin's annuities. Merrill's chairman, Mr Roger Birk, said his firm and taken the action to "maintain the continued confidence of customers, and potential customers worldwide."

However, state insurance regulators who are now supervising the Baldwin insurance operations object to the voluntary plans now being proposed by some but not all of the sellers of Baldwin-United annuities, since they argue that one group of policyholders should not be treated differently from another group.

As a result they are pressing the

stockbrokerage and life insurance industries to provide an industry-wide pool of funds which can be used towards improving the returns on the Baldwin-United annuities. One of the main problems is that part of the money invested in the annuities was reinvested in other parts of Baldwin's failed business.

At one stage Baldwin was the market leader in the single premium deferred annuity market.

Industry sources estimate that the U.S. stockbrokers could contribute around \$300m to the fund and the life insurance another \$50m. However, they note that getting an industry-wide agreement on the size of individual contributions and the method of distributing the money are likely to pose serious obstacles.

Cermoc faces bankruptcy again

BY DAVID GARDNER IN MEXICO CITY

THE THREAT of bankruptcy hanging over Cerveceria Moctezuma (Cermoc), one of Mexico's leading breweries, which owes \$370m abroad, has revived following the opening of new legal proceedings against the company by one of its creditors.

Northwestern National Bank of Minneapolis, which in January sought a bankruptcy order against Cermoc to recover the \$37m it is owed by Distribuidora Moctezuma, the brewery's distribution subsidiary, has filed a new suit seeking an embargo on the distributor.

The move follows the impasse reached in talks, between Cermoc, its foreign creditors and the Government, aimed at restructuring the company. The principal sticking point, according to bankers here, is the unwillingness of Cermoc's main shareholder, Sr Alberto Bailleres, to cede a stake in the company to the foreign banks in return for capitalisation of part of the debt.

Proposals put forward by the banks, in collaboration with the Mexican authorities, called for the banks to convert either \$40m into a 30 per cent stake, or \$80m into a 60 per cent holding. Under the first option, Sr Bailleres - head of a powerful business empire which includes Industrias Peñoles, the world's largest silver producer - would put up \$40m of his own capital.

Under the proposals, the brewery would come up to date fully on back taxes of more than \$80m and the Government would pump back \$40m in exchange for convertible preferred shares in the company redeemable over 10 years.

In addition to the \$120m package, \$200m would be rescheduled over 10 years, at 12 per cent for the first five years and London interbank offered rate (Libor) plus 2 for the second five years. Another \$120m would be repaid at 4 per cent for the first two years, 12 per cent for the

next three years, and Libor plus 2 for the remaining five years.

Cermoc, however, is understood to have rejected outside participation in the control of the company, and is seeking easier repayment terms. Although talks were still going on yesterday the prospects for agreement appeared sufficiently slight for Northwestern to renew its legal battle with the brewery.

Sr Bailleres and the Cermoc shareholders nevertheless retain a strong hand in the short term. The Cermoc board was empowered, at an extraordinary general meeting on January 23, to declare a suspension of payments - a move which amounts to applying to the courts for temporary receivership - should this be necessary to counter bankruptcy proceedings.

Although suspending all payments would forestall any decision to liquidate, it is not clear what effect it would have in fending off the new lawsuit.

McDonnell Douglas earnings up 13%

By Our Financial Staff

McDONNELL Douglas, the U.S. aerospace group, has posted a 13 per cent rise in first-quarter net earnings as operating improvements in aerospace and information systems more than offset higher interest costs and "substantially lower" transport aircraft sales.

Profits rose from \$58.9m or \$1.51 a share to \$67.5m or \$1.68, on sales down slightly from \$2.07bn to \$2.03bn. The latest results include sales and earnings of Hughes Helicopters, acquired earlier this year from the Howard Hughes estate for \$470m, and Computer Sharing Services, bought from Rio Grande Industries for \$68.2m. Results of Tymshare, the California-based data transmission company acquired in March, are excluded.

McDonnell Douglas said it delivered two MD-80 twin-jet commercial airliners and two KC-10 tri-jet military cargo aircraft in the latest quarter. This compares with six twin-jets and four DC-10 tri-jets in the first quarter of 1983.

The company said its firm backlog of orders at March 31 was \$14.5bn, 50 per cent higher than a year earlier. Hughes Helicopters accounted for \$1,066m of the latest total, which excludes government orders not yet funded to McDonnell and orders being negotiated to continue authorised programmes.

The total backlog, which includes these additional amounts but excludes options and aircraft being built for short-term lease, was about \$22.6bn, compared with \$17.9bn.

In February American Airlines, the second largest U.S. carrier, ordered 67 MD-80s for delivery in 1985-87 and took options on a further 100.

Mobil and Sohio profits surge in first three months

BY TERRY DODSWORTH IN NEW YORK

MOBIL, the second largest U.S. oil group, reported a 32 per cent rise in first quarter net income, from \$250m or 62 cents a share to \$380m or 93 cents a share. Sales rose to \$15bn from \$14.3bn.

Sohio, the Cleveland-based group in which British Petroleum has a majority stake, announced a 38 per cent increase in earnings from \$277m or \$1.12 a share to \$381m or \$1.54 a share.

A large part of the improvement in Sohio's figures, however, was due to the reduction in the net figure last year after a \$75m extraordinary charge for the closure of an abrasives operation. Sales increased to \$2.92bn compared with \$2.7bn.

A \$74m turnaround at Shell Oil's U.S. refining and marketing operations was primarily responsible for the group's 33 per cent rise in first-quarter net income from \$240m to \$328m.

This equalled \$1.05 a share, against 80 cents last time, on revenue of \$4.96bn, against \$4.65bn.

The group's U.S. oil and gas exploration and production earnings rose 57m to \$310m. The oil products operations, which cover Shell's refining and marketing operation, earned \$34m against a loss of \$40m, and chemical products increased its contribution by \$1m to \$21m.

Daily crude production rose 2 per

cent and natural gas production 8 per cent in the quarter.

Gulf Corporation, which has agreed a bid from Standard Oil Company of California (Socal), reports a 21 per cent rise in its first-quarter net income from \$182m or \$1.06 a share to \$220m or \$1.33. Revenues rose to \$7.5bn (\$6.9bn).

Excluding non-recurring items and currency translation charges, Gulf said its net income from operations in the latest quarter was double last year's figure and 20 per cent up on the fourth quarter of 1983.

Pennzoil, the Houston-based energy company which recently failed in a bid to win control of Getty Oil, has increased its first quarter net income by 68 per cent from \$41.3m or 78 cents a share to \$69.2m or \$1.25. Revenues were \$674m (\$598.8m).

Amerada Hess, the New York-based integrated oil company, extended the recovery which began in the second quarter of 1983 by boosting first-quarter 1984 net earnings to \$88.4m or \$1.04 a share, against just \$5m or 6 cents in the comparable period. Revenues advanced from \$1.8bn to \$2.4bn.

The rise in earnings was mainly the result of a sharp reduction in losses from refining and marketing to \$4.3m from \$61m.

Reliance seeks Disney stake

BY OUR NEW YORK STAFF

RELIANCE Financial Services, part of financier Mr Saul Steinberg's privately held Reliance Group Holdings investment company, is seeking a stake of up to 25 per cent in Walt Disney Productions, the U.S. entertainment group.

Reliance, which has already built up a 9.3 per cent stake in Disney, revealed the move in a filing with

the Securities and Exchange Commission and said it is seeking Federal Trade Commission and Justice Department anti-trust division approval to boost its holding.

Disney's shares have been rising rapidly in recent months, boosted by takeover speculation. On Wednesday the stock closed up \$3 to \$62.50 in New York.

Financial services activities hit Xerox

By Terry Dodsworth in New York

XEROX, the U.S. office equipment and financial services company, has joined the growing list of victims of the crisis in the U.S. property and casualty insurance business.

Despite an 11 per cent increase in profits of the duplicator and information systems division, net income in the first quarter of this year fell by 2 per cent from \$128.7m, or \$1.25 a share, to \$126.1m or \$1.20 a share.

The company put the blame for this decline squarely on the financial services activities, and more specifically on the insurance company Crum and Forster. Crum's quarterly net income fell by 33 per cent from \$37m to \$35m, even though it made capital gains of \$14m this year against \$2m in 1983.

Mr David Kearns, president, said that like the rest of the property and casualty insurance industry, Crum and Forster had been hit by "severe weather conditions and continued price pressures on commercial insurance lines."

After allocating interest costs associated with the acquisition of this business and the Van Kampen Merit Investment Bank, financial services contributed \$32m to the first quarter profits against \$4m a year ago.

On the office equipment side of the business, Mr Kearns said that customer response to the 10 series copier/duplicators had been "excellent around the world," and had required an increase in production schedules.

Income in this division had risen to \$94m on revenues of \$2bn, against \$85bn, on virtually the same sales a year ago.

Sales revenue was undermined, Mr Kearns said, by the strength of the U.S. dollar compared to a year ago, weak economic conditions in several countries and lower price levels worldwide.



This Malaysian tiger has international trade financing at its feet.

The tiger is the symbol of Malaysian Banking, Malaysia's Largest Banking Group. Our strength, size and reputation for handling large syndicated credits, have given us the experience and resources to offer you superior trade services - Documentary Credits and Collections, Bills of Exchange Purchase and Trust Receipts. We have a staff of trade service specialists who are in

TOTAL ASSETS EXCEEDING US\$ 6.6 BILLION.
OVER 180 BRANCHES IN MALAYSIA AND ABROAD.
OVER 1.5 MILLION ACCOUNT HOLDERS.
LARGEST BANKING GROUP IN MALAYSIA, COMPRISING COMMERCIAL AND MERCHANT BANKS, FINANCE, LEASING AND INSURANCE COMPANIES.

MALAYAN BANKING BERHAD
Malaysia's Largest Banking Group.

constant touch with the major centres of the world. And a widespread network with branches in Hong Kong, London, Hamburg and correspondent banks all over the world.

To find out more about how we can meet your needs, contact:
Mr. Lee Chen Chong
74 Coleman Street,
London EC 2R 5BN.
Tel: 6380561
Telex: 888586
MIBLDN G

New issue

This announcement appears as a matter of record only.

April 27, 1984



Mount Isa Finance N.V.

Curaçao, Netherlands Antilles

DM 100,000,000

7 3/4% Deutsche Mark Bearer Bonds of 1984/1992

under the irrevocable and unconditional guarantee of

M.I.M. Holdings Limited

Brisbane, Queensland, Australia

Issue Price: 100% - Interest: 7 3/4% p.a., payable annually in arrears on April 28 - Redemption: on April 28, 1992 at par - Denomination: DM 1,000 and DM 10,000 - Security: irrevocably and unconditionally guaranteed by M.I.M. Holdings Limited, Brisbane, Queensland, Australia, Negative Pledge Clause - Listing: Frankfurt/Main

KREDITBANK INTERNATIONAL GROUP	KUWAIT INTERNATIONAL INVESTMENT CO. s.a.k.	LTCB INTERNATIONAL LIMITED
MANUFACTURERS HANOVER LIMITED	SOCIETE GENERALE	UNION BANK OF SWITZERLAND (SECURITIES) LIMITED
Abu Dhabi Investment Company Algemeen Bank Nederland N.V. Al-Mal Group Amro International Limited Arab Banking Corporation - Daus & Co. GmbH Australia and New Zealand Banking Group Limited Julius Baer International Limited Banca del Gottardo Banca della Svizzera Italiana Banca di Roma BankAmerica Investment Banking Group Bank Leu International Ltd. Bank Wires & Hope NV Bank of Tokyo International Limited Banque Bruxelles Lambert S.A. Banque Generale du Commerce Extérieur Banque Generale du Luxembourg S.A. Banque Internationale à Luxembourg S.A. Banque Nationale de Paris Banque Paribas Banque de Paris et des Pays-Bas (Suisse) S.A. Banque Populaire Suisse S.A. Luxembourg Barclays Bank Group Baring Brothers & Co. Limited Bayerische Hypothek- und Wechsel-Bank Aktiengesellschaft Bayerische Landesbank Girozentrale Bayerische Vereinsbank Aktiengesellschaft Joh. Bevoigt, Goslar & Co. Berliner Bank Aktiengesellschaft Berliner Handels- und Frankfurter Bank Blyth Eastman Paine Webber International Limited Caisse des Dépôts et Consignations Chase Manhattan Limited Chemical Bank International Limited Citicorp Capital Markets Group CIBC Limited Commerzbank International S.A.	Commerzbank (South East Asia) Ltd. Continental Illinois Capital Markets Group County Bank Limited Creditoital-Banklovere Crédit Commercial de France Crédit Lyonnais Crédit Suisse First Boston Limited Daiwa Europe Limited DeLbrick & Co. DG Bank Deutsche Genossenschaftsbank Deutsche Bank Aktiengesellschaft Deutsche Girozentrale Deutsche Kommunalbank - Dominion Securities Ames Limited Dresdner Bank Aktiengesellschaft Effektenbank-Warburg Aktiengesellschaft Euronormilare S.p.A. EuroPartners Securities Corporation European Arab Bank European Banking Company Limited Fuji International Finance Limited Girozentrale und Bank der Österreichischen Sparkassen Aktiengesellschaft Goldman Sachs International Corp. A.C. Goode & Co. (UK) Limited Hambros Bank Limited Georg Hauck & Sohn Bankiers Kommunalfonds-Gesellschaft auf Aldien Hessische Landesbank - Girozentrale - Hill Samuel & Co. Limited Industriebank von Japan (Deutschland) Aktiengesellschaft Istituto Bancario San Paolo di Torino Kidder, Peabody International Limited Kleinwort, Benson Limited Kreditbank S.A. Luxembourggoise Kuwait Foreign Trading Contracting & Investment Co. (S.A.K.) Kuwait Investment Company (S.A.K.)	Lehman Brothers Kuhn Loeb International, Inc. Lloyds Bank International Limited Merck, Finck & Co. Merrill Lynch Capital Markets B. Metzler seel. Sohn & Co. Mitsubishi Finance International Limited Samuel Montagu & Co. Limited Morgan Grenfell & Co. Limited Morgan Guaranty Ltd Morgan Stanley International The Nikko Securities Co. (Europe) Ltd. Nippon Credit International (HK) Limited Nomura International Limited Norddeutsche Landesbank Girozentrale Sal. Oppenheim jr. & Cie. Orion Royal Bank Limited Potter Partners Samwa Bank (Underwriters) Limited J. Henry Schroder Wagg & Co. Limited Smith Barney, Harris Upham & Co. Incorporated Société Générale de Banque S.A. Sunilomo Finance International Svenska Handelsbanken Group Swiss Bank Corporation International Limited Trinkaus & Burkhart Vereins- und Handelsbank Aktiengesellschaft J. Vontobel & Co. M.M. Warburg-Brückmann, Wirtz & Co. S.G. Warburg & Co. Ltd. Wardley J.B. Were & Son Westdeutsche Landesbank Girozentrale Westfalentbank Aktiengesellschaft Westpac Banking Corporation Wood Gundy Limited Yamaichi International (Europe) Limited

INTL: COMPANIES & FINANCE

Jonathan Carr on how Hypo and BV have outgrown their regional status
Bavarian banks break into big time

Table with 4 columns: Parent bank, Bayerische Vereinsbank DM, % Change on 1982, Hypo-Bank DM, % Change on 1982. Rows include Total assets, Net interest income, Net commission income, Partial operating income, Net profit, Consolidated total assets.

THE TOP managers at Bayerische Hypotheken- und Wechselbank (Hypo) must be chortling with glee. The bank's profits performance in 1983 was not only better in some key respects than that of its arch-rival Bayerische Vereinsbank (BV), but it also emphasised that in earnings power Hypo is very close to the top of the tree among all West German credit institutions, admittedly with the BV peering along close behind.

This advertisement appears as a matter of record only

March, 1984



MALAYSIA

¥ 30,000,000,000

Term Loan

Floating Rate Tranche

Fixed Rate Tranche

Lead Managed by

The Dai-ichi Kangyo Bank, Limited

The Long-Term Credit Bank of Japan, Limited

Co-Lead Managed by

Bank Bumiputra Malaysia Berhad, The Fuji Bank, Limited, The Mitsubishi Bank, Limited, The Sanwa Bank, Limited, The Sumitomo Bank, Limited

The Bank of Tokyo, Ltd., The Industrial Bank of Japan, Limited, The Nippon Credit Bank, Ltd.

The Sumitomo Trust and Banking Company, Limited

managed by

The Bank of Yokohama, Ltd., Manufacturers Hanover Trust Company, The Saitama Bank, Ltd., The Taiyo Kobe Bank, Limited, The Tokai Bank, Limited, The Yasuda Trust and Banking Company, Limited

The Chase Manhattan Bank, N.A., The Dai-ichi Mutual Life Insurance Company, The Dai-ichi Trust and Banking Corporation, Mitsui Mutual Life Insurance Company, The Dai-ichi Trust and Banking Company, Limited, Nippon Life Insurance Company, Sumitomo Life Insurance Company

provided by

List of participating banks including Dai-ichi Kangyo Bank, Fuji Bank, etc.

List of participating banks including Long-Term Credit Bank of Japan, Bank of Tokyo, etc.

List of participating banks including Bank of Tokyo, Nippon Credit Bank, etc.

Agents

The Dai-ichi Kangyo Bank, Limited

The Long-Term Credit Bank of Japan, Limited

This announcement appears as a matter of record only

New Issue February, 1984



European Investment Bank

Flux 1,000,000,000
10 1/2% Bonds 1984-1994

Underwritten and placed by

Banque Internationale à Luxembourg

- List of participating banks: Banque Générale du Luxembourg, Kredietbank S.A. Luxembourg, Caisse d'Epargne de l'Etat Luxembourg, etc.

Mars 1984 Emission Nouvelle



Cet emprunt ayant été entièrement souscrit, le présent avis est publié à titre d'information seulement.

Commission de transport de la Communauté urbaine de Montréal
Province de Québec, Canada

Emprunt obligataire 12 1/2 % 1984-1991 de 20 000 000 \$ Can.

BANQUE INTERNATIONALE À LUXEMBOURG

- List of participating banks: BANK GUTZWILLER, KURZ, BUNGENER, BANQUE BRUXELLES LAMBERT S.A., etc.

Saab sales off to good start

BY KEVIN DONE, NORDIC CORRESPONDENT IN STOCKHOLM

SAAB-Scania, the Swedish motor and aerospace group, increased sales by 24 per cent to SKr 6.17bn (\$779m) in the first three months of the year, Mr Georg Karnsund, the managing director, said yesterday.

around SKr 150,000 in Sweden, where it will compete with Volvo's top of the range 760 model.

Mr Karnsund said the group had every reason to be optimistic about profits, which are expected to show a substantial increase this year, despite the costs of launching the new model.

Truck and bus production is expected to rise to some 23,000 this year from 18,500 in 1983, while car output is expected to rise by 10 per cent to 108,000.

Continuing investment will have expanded car production capacity to 120,000 units a year by the end of 1984.

Ciba completes UK restructuring

BY JOHN WICKS IN ZURICH

CIBA-GEIGY, the Swiss chemical company, has completed "on schedule and within the budgeted costs" the restructuring of its UK photographic division, it was stated yesterday.

in 1983, Ifford turnover went up by 5 per cent to SwFr 445m, or by 10 per cent in terms of local currencies. Sales increased at a further "gratifying" rate of 11 per cent in Swiss franc terms in the first quarter of this year.

Total turnover of the Ciba-Geigy concern increased in the first quarter by 22 per cent in comparison with the corresponding period of 1983 to SwFr 4.9bn.

Dr Louis Von Planta, company chairman and managing director, said it was unlikely that this growth rate would be maintained for the remainder of the year. The first quarter had seen a particularly sharp increase in agricultural chemicals business because of a change in U.S. agricultural policy, and also in industrial chemicals.

North American Quarterly Results

Table with 4 columns: Company Name, 1984 Q1, 1983 Q1, 1984 Q1, 1983 Q1. Rows include THERATE, TRANSAMERICA, U.S. GYPSUM, U.S. AIR, U.S. CHEMICALS, U.S. GYPSUM, U.S. CHEMICALS, U.S. GYPSUM, U.S. CHEMICALS.

AMIC plans rights issue to raise R100m

By Our Johannesburg Correspondent

ANGLO-AMERICAN Industrial Corporation (AMIC), the industrial arm of the South African mining house Anglo American, plans to raise R100m (\$78m) by means of a rights issue of ordinary shares.

Mr Graham Bousted, the chairman, told the annual general meeting in Johannesburg yesterday, that the proceeds of the issue will supplement AMIC's existing resources and will be used to finance the group's participation in capital projects. The terms of the issue have yet to be announced.

Mr Bousted told the meeting that the group is budgeting for an increase in earnings in 1984 and that it intended to, at least, maintain the dividend at 180 cents a share on the increased capital.

In 1983 AMIC's turnover declined to R1.6bn, from R1.4bn, while the pretax trading profit dropped to R211.8m from R248.1m.

AMIC has at present 45.68m ordinary shares in issue. At yesterday's closing price of R22.50 a share on the Johannesburg Stock Exchange, the group has a market capitalisation of R1.48bn.

Superfos back to profits
By Our Copenhagen Correspondent

SUPERFOS, the Danish chemicals group, has bounced back to profits for 1983 but will again not pay a dividend.

Sales rose by a fifth during the year, but the main driving force behind the recovery has been the elimination of ammonia losses in West Germany.

Profits before tax emerge at DKr 219m (\$22m) in contrast to a deficit for 1982 of DKr 85m. Sales were DKr 7.6bn, against DKr 6.3bn.

In the interests of continued recovery, no dividend is proposed.

Superfos attributes the improved result to a better general performance linked to the advantageous effects of the sale of the 40 per cent share in a Veba-controlled ammonia plant in West Germany.

The West German plant was the main reason for Superfos' losses in 1981 and 1982.

Bank of Tokyo (Curacao) Holding N.V.

GUARANTEED FLOATING RATE NOTES DUE 1989

US\$50,000,000

Payment of the principal of, and interest on, the Notes is unconditionally and irrevocably guaranteed by The Bank of Tokyo, Ltd.

In accordance with the provisions of the Agency Agreement between Bank of Tokyo (Curacao) Holding N.V., The Bank of Tokyo, Ltd., and Citibank, N.A., dated October 23, 1979, notice is hereby given that the Rate of Interest has been fixed at 1 1/2% p.a. and that the interest payable on the relevant Interest Payment Date, July 27, 1984, against Coupon No. 19 will be US\$40.61.

April 27, 1984, London By: Citibank, N.A. (CSSI Dept), Agent Bank CITIBANK

U.S.\$30,000,000

GRUPO INDUSTRIAL SALTILLO S.A.

Floating Rate Notes due 1988

In accordance with the provisions of the Notes notice is hereby given that for the six months interest period from 27th April 1984 to 27th October 1984 the Notes will carry an interest rate of 12 1/2% per annum. The relevant Interest Payment Date will be 27th October, 1984 and the interest then payable against coupon No. 6 will be U.S.\$ 3099.39 per U.S.\$ 50,000 Note and U.S.\$309.94 per U.S.\$5,000 note.

27th April 1984 By: Citicorp International Bank Limited, Agent Bank

Handwritten note in Arabic script: "ملاحظات على الترخيص"

Notice of Mandatory Redemption

ORIENT LEASING (CARIBBEAN) N.V.

US\$30,000,000 12% Guaranteed Notes Due 1985

Notice is hereby given pursuant to the provisions of the Trust Deed dated May 21, 1980 constituting the above Notes, that \$10,000,000 nominal of the Notes is due for mandatory redemption on June 1, 1984. Pursuant to Clause 5(d) of the Terms and Conditions of the Notes US\$2,420,000 principal amount has been purchased by the Company and credited against the amount due for redemption.

The serial numbers of the Notes drawn for redemption representing \$7,580,000 principal amount are as follows:—

Table listing serial numbers of notes for redemption, organized in columns. Includes handwritten 'big' in the left margin.

On June 1, 1984, there will become due and payable on the Notes to be redeemed the principal amount thereof together with accrued interest to June 1, 1984. On and after that date interest on the Notes to be redeemed shall cease to accrue. Payment of Notes to be redeemed will be made on or after June 1, 1984 upon presentation and surrender of said Notes, with all coupons appertaining thereto maturing after June 1, 1984 at any of the following banks:—

- List of banks: The Chase Manhattan Bank, N.A.; Chace Manhattan Bank Luxembourg S.A.; Banque Internationale A Luxembourg S.A.; Banque de Commerce S.A.; The Development Bank of Singapore Ltd.; Stockerstrasse 33, Zurich; Industrial Bank of Japan; United Overseas Bank Ltd.; Sanwa Bank Ltd.; The Chase Manhattan Bank, N.A.

With effect from June 1, 1984, the balance of Notes remaining in circulation will be \$10,000,000. Dated: April 27, 1984. The Chase Manhattan Bank, N.A., Principal Paying Agent.

INTL. COMPANIES & FINANCE

MORGAN STANLEY

takes pleasure in announcing the opening of its

Australia and New Zealand

Representative Office under the direction of

BRUCE R. BOCKMANN, Managing Director
JOHN H. MURRAY, Vice President

Morgan Stanley International Incorporated
Level 38, MLC Centre
19-29 Martin Place
Sydney, N.S.W. 2000, Australia

Telephone: (02) 238-8933 Telex: AA 75688 MORSTN Facsimile: (02) 235-2304

This advertisement complies with the requirements of the Council of The Stock Exchange of the United Kingdom and the Republic of Ireland.



AIR CANADA

(A Federal Crown corporation, wholly-owned by the Government of Canada)

£40,000,000

11 1/4 per cent. Bonds 1994

Issue price 100 per cent.

The following have agreed to subscribe or procure subscribers for the above Bonds:—

- County Bank Limited
- Barclays Bank Group
- Deutsche Bank Aktiengesellschaft
- Samuel Montagu & Co. Limited
- Orion Royal Bank Limited
- Wood Gundy Limited
- Daiwa Europe Limited
- Hambros Bank Limited
- Morgan Grenfell & Co. Limited
- Société Générale de Banque S.A.
- Swiss Bank Corporation International Limited

The 8,000 Bonds of £5,000 each constituting the above issue of Bonds have been admitted to the Official List of The Stock Exchange of the United Kingdom and the Republic of Ireland, subject only to the issue of the Bonds. Interest is payable annually on 1st May, the first such payment being due on 1st May, 1985.

Particulars of the Bonds and of Air Canada are available from Exel Statistical Services Limited and may be obtained during normal business hours up to and including 11th May, 1984 from:—

Rowe & Pitman, City-Gate House, 39-45 Finsbury Square, London EC2A 1JA
Phillips & Drew, 120 Moorgate, London EC2M 6XP

27th April, 1984

This announcement appears as a matter of record only. These securities have not been registered for offer or sale in the United States.

Offer for Sale

150,000 B-Shares

of

Radiometer A/S

at

Dkr. 420,000,000

Privatbanken A/S

Goldman Sachs International Corp.

Broker: Cazenove & Co.

April 27, 1984

Jefferies Ltd

Elders IXL to take over Pica for \$20m

By Our Financial Staff

ELDERS IXL, the fast-growing Australian pastoral, resources, financial and diversified industrial group, is to take over Private Investment Company for Asia (Pica), the investment banking group formed in 1989 to help foster the growth of private enterprise in Asian countries.

In a joint statement, the two companies said yesterday that an Elders subsidiary, Elders Finance and Investment, would pay US\$20m to Pica's shareholders, whose approval is still required for the deal. The company's total assets were said to be worth \$231m at the end of 1983.

Pica was set up by 24 major companies in Europe, the U.S., Japan, Australia and Canada in 1989 with an authorised capital of \$40m and a stated aim of encouraging the development of private sector business. The number of shareholders has since increased to some 260, while the company is currently operating in 12 East Asian countries.

The company has taken equity positions in and made loans to a wide spread of industries. On a geographical basis, some 20 per cent of its total exposure is currently in the Philippines, according to Dr Wolfgang Sletz, managing director.

Korea to cut short-term foreign debt

BY PETER MONTAGNON IN AMSTERDAM

SOUTH KOREA plans to reduce its short-term foreign debt by about \$500m and \$600m this year in an effort to improve its debt maturity profile, Mr Kim Mahn-Je, Finance Minister, said here yesterday.

An increased availability of medium-term finance has enabled Korea to aim for a speedier reduction in short-term borrowing than previously expected, he told the Financial Times. Short-term loans accounted for about one-third of the country's \$40bn total debt outstanding at the end of 1983.

Previous forecasts have suggested only a modest reduction in short-term borrowing, of about \$200m, but the Minister said that the Philippines debt problem had made Korea aware of the need to reduce its vulnerability to the withdrawal of short-term credit lines.

Korean banks are now expected to step up their medium-term borrowings in the floating rate certificate of deposit market. Based on current projections, Korea's total gross foreign borrowing this year should be around \$6.5bn, of which \$1bn will be used to cover the current account balance of payments deficit, he said. Amortisation of maturing debt will absorb \$3bn, while remaining borrow-

ing will be used to pre-finance Korean exports. A sharp increase in imports so far this year and the higher cost of debt service resulting from the increase in U.S. interest rates—each one point rise in rates costs South Korea about \$250m a year—means that it will not be possible for Korea to reduce its balance of payments below \$1bn this year, the Minister said.

But the net increase in Korea's foreign debt will still be confined to about \$1.5bn this year and by 1988 the debt should peak at about \$45bn. About three-quarters of Korea's foreign debt is de-

nominated in U.S. dollars and further efforts will be made to diversify borrowings through fund-raising on the Swiss and German bond markets this year.

Korea Exchange Bank recently concluded a \$650m borrowing in the Eurocredit market. Korea Eximbank is expected to raise about \$300m during the summer or early autumn. After that Korea Development Bank will raise about \$500m.

Mr Kim also said that Korea was now encouraging foreign borrowing by private sector corporations, "but we are cautious about moving in that direction with a large sum."

PLASCON-EVANS (Plevans), South Africa's largest paint manufacturer which is 80 per cent owned by Barlow Rand, is uncertain on prospects for the remainder of the current financial year. In the six months ended March 31, turnover was R123.3m (1983m) against R108.2m in the corresponding period of 1983 and R221m in the financial year which ended on September 30, 1983.

The first-half's operating profit before interest and tax rose to R14.3m from R11.5m. In the last financial year operating profit totalled R27.4m.

The directors say they cannot forecast the second half's performance due to the delayed economic recovery and the unknown effects of drought and storm damage on demand for paint.

An interim dividend of 8 cents has been declared from first-half earnings of 29 cents a share. Last year's interim dividend was 6 cents and first-half earnings 26 cents a share.

The directors forecast an unchanged total dividend this year.

Moët-Hennessy boosts earnings

BY DAVID MARSH IN PARIS

MOËT-HENNESSY, the diversified French champagne company, yesterday announced a big advance in first quarter 1984 sales after declaring net group profits up 16 per cent to FF401.8m (\$48m) for 1983.

France's largest champagne producer has made major efforts in recent years to widen its product range across cognac, perfumes and horticultural activities, and also to spread its international presence. The group boosted turnover by 29 per cent in the first quarter, although it was unlikely to keep up the growth rate for the whole year, M. Alain Chevalier, the chairman, told a press conference.

Describing the 1983 results as "better than expected," M. Chevalier said the group intended further to build up its U.S. activities—which already make up one-third of its business—and also to expand Asian operations. At present these make up around 10 to 15 per cent of turnover, but the aim is to expand them to one-third, led by the strong Japanese market for cognac and perfumes.

Last year's sales rose 25 per cent to FF5,740m, with operating profits up 16 per cent to FF846m. Sales and profits have both doubled since 1980.

Admitting that he could hardly avoid a certain "self-satisfaction," M. Chevalier said the group's product mix had managed to protect it from the last few years of difficulties in the champagne business, while its geographical spread gave it some insulation from economic and currency fluctuations.

The dividend for last year is being increased to FF20 (FF30 counting a FF10 tax credit) a share compared with the FF19 in 1982.

Champagne and wines account for 46 per cent of turnover, cognac and spirits 28 per cent and perfumes and beauty products—including the Dior and Roc ranges—25 per cent.

Barbara laboratory would produce 600,000 to 700,000 roses this year using "in vitro" test-tube breeding techniques pioneered in France.

Following market tests—in California, distribution of test-tube-bred roses around the U.S. would start next year.

The rise of the dollar, in which 35 per cent of Moët's sales are invoiced, clearly boosted last year's overall turnover increase. On the basis of unchanged currency rates—but without allowing for price increases which would have taken place had the dollar remained stable—last year's turnover rise would have been around half the 25 per cent actually recorded.

Credit Suisse growth

BY JOHN WICKS IN ZURICH

CREDIT SUISSE reports a "continuation of gratifying results" in the first quarter of 1984. The Zurich bank, whose net profits had risen last year by 16 per cent to a record SwFr 351.8m (\$151.7m), says its business was up on that for the corresponding period of 1983.

Income for both interest and non-interest business remained good during the first quarter, according to a Credit Suisse communique, while costs were kept rather below the budgeted level.

Due to a seasonal reduction of the high end-of-year liquidity, the bank's balance-

sheet total dropped by 1 per cent over the quarter of SwFr 76.4bn, despite a 1 per cent growth to SwFr 51.1bn in the volume of clients' deposits. Advances to clients on the assets side of the balance sheet remained virtually unchanged from the end-of-year figure of SwFr 35.6bn.

In interbank business, the Swiss figure fell sharply from SwFr 15,476m to SwFr 15,339m following a fall in time deposits with other banks, while the due-from-banks total rose from SwFr 18.8bn to SwFr 19.42bn, with time accounts up from SwFr 16.64bn to SwFr 17.45bn.

Sun Hung Kai spending

HONG KONG — Sun Hung Kai Properties plans to spend over HK\$2bn (U.S.\$250m) over the next two years on new and ongoing developments centred in the new territories of Hong Kong, an official of the company told Reuters.

A residential/commercial development site of over 50,000

sq metres in the northern part of the territory, known as Tai Po Centre, highlights Sun Hung Kai's developments, he said.

Sun Hung Kai plans to invest up to HK\$1bn in Tai Po Centre, started this week, he added, saying that the first phase is likely to be completed by mid 1985.

JAPANESE RESULTS

KAO CORPORATION		MITSUBISHI PETROCHEMICAL CORPORATION	
Year to	Mar '84 Mar '83	Year to	Dec '83 Dec '82
Revenue (bn)	320.61 326.85	Revenue (bn)	402.22 398.50
Pre-tax profits (bn)	13.27 12.10	Pre-tax profits (bn)	0.54 116.49
Net profits (bn)	8.25 5.82	Net profits (bn)	0.22 15.07
Dividend	7.50 7.50		

MARKITA ELECTRICAL WORKS ELECTRIC TOOLS		IFB-FIAT FINANCE CORPORATION B.V.	
Year to	Feb '84 Feb '83	Year to	Feb '84 Feb '83
Revenue (bn)	91.19 79.73	Revenue (bn)	522.04 545.54
Pre-tax profits (bn)	15.47 12.38	Pre-tax profits (bn)	9.20 14.47
Net profits (bn)	9.51 5.58	Net profits (bn)	5.98 16.08
Dividend	18.0 18.0	Dividend	6 10

GUARANTEED FLOATING RATE NOTES 1991. For the six months 30/4/84 to 31/10/84. The Notes will carry an interest rate of 11 1/4% per annum. Coupon US\$8.46 Listed on the Stock Exchange, Luxembourg. Agent Bank: National Westminster Bank PLC, London.

MITSUBISHI DEPARTMENT STORE	
Year to	Feb '84 Feb '83
Revenue (bn)	522.04 545.54
Pre-tax profits (bn)	9.20 14.47
Net profits (bn)	5.98 16.08
Dividend	6 10

US \$50,000,000 CYDSA, S.A. (Incorporated in the United Mexican States) Floating Rate Notes due 1988

In accordance with the provisions of the Notes issued under the Trust Indenture between CYDSA, S.A. and The Royal Bank and Trust Company, dated as of October 28, 1981, and with the provisions of the Paying Agency and Agent Bank Agreement between CYDSA, S.A., Continental Bank International and Continental Bank Limited, dated as of October 28, 1981, notice is hereby given that the Rate of Interest for the six month Interest Period has been fixed at 12 1/4% per annum and that the interest payable on the relevant Interest Payment Date, 31st October, 1984, against Coupon No. 6 in respect of US \$10,000 nominal amount of the Notes will be US \$616.53.

Agent Bank: Continental Illinois Limited April 27, 1984.

N.V. GEMEENSCHAPPELIJK BEZIT VAN ANDEELEN PHILIPS' GLOEIAMPENFABRIEKEN
(Philips' Lamp Holding) Eindhoven, The Netherlands

CASH DIVIDEND At the Ordinary General Meeting of Shareholders held on 26th April 1984, a total dividend in cash for the year 1983 has been declared of 1.30 Netherlands Guilders per ordinary share of 10 guilders nominal value. After giving effect to the interim dividend of 0.80 guilders previously declared and paid in January 1984, a final dividend for the year 1983 amounting to 1.20 guilders will become payable. The above-mentioned final dividend of 1.20 guilders per share will be payable as of 9th May 1984.

Payment of the net amount on UK-CF certificates will be made by the company's paying agent, Hill Samuel & Co. Limited, 46 Beach Street, London EC2P 2LX to the UK-CF depositaries in accordance with their positions in the books of CF Amsterdam on 28th April 1984, at the close of business.

Holders of UK-CF certificates are reminded that such payment is subject to deduction of 25 per cent Netherlands Withholding Tax. This 25 per cent may however, be reduced to 15 per cent, when payment is made to residents of the United Kingdom or to residents of Australia, Austria, Belgium, Canada, Denmark, Finland, France, Western Germany, Ireland, Japan, Luxembourg, Netherlands Antilles, New Zealand, Norway, South Africa, Spain, Sweden and the United States of America, who deliver through the UK-CF depositary the appropriate Tax Declarations to the company's agent Hill Samuel & Co. Limited. The Netherlands Withholding Tax may be reduced to 20 per cent when payment is made to residents of Indonesia who deliver the appropriate Tax Declaration in the above-mentioned way.

Unless you request Hill Samuel & Co. Limited no later than 4th May 1984 to receive the dividend in guilders with a bank in the Netherlands on 9th May 1984 for some or all of the shares deposited with you, they will transfer to you the dividend in sterling based on the sterling/guilder rate of exchange valid on 11th May 1984.

DISTRIBUTION OF ORDINARY SHARES: 1 FOR 10 At the General Meeting of Shareholders on 26th April 1984, it was further decided to make a distribution of ordinary shares such that one ordinary share of HFL 10, is issued for every 10 shares outstanding. This distribution is made in connection with the corresponding decision of the General Meeting of Shareholders of N.V. Philips' Gloeilampenfabriek to make a distribution in ordinary shares chargeable to the tax-free share Premium Account.

The new shares will become available as from 9th May 1984, in the United Kingdom in the form of UK-CF Certificates at the office of Hill Samuel & Co. for UK-CF depositaries only against transfer of CF rights.

The distribution of shares is not subject to Netherlands Dividend/Income Tax. The shares of this distribution which have not been claimed by 30th November 1984, will be sold for the account of those entitled.

Eindhoven, 27th April 1984. The Board of Governors. PHILIPS

US\$100,000,000 FLOATING RATE DEPOSITARY RECEIPTS DUE 1991 issued by The Law Debenture Trust Corporation plc evidencing entitlement to payment of principal and interest on deposits with

BNL Banca Nazionale del Lavoro
(Incorporated as an Istituto di Credito al Diritto Pubblico in the Republic of Italy)
London Branch
Notice is hereby given that the Rate of Interest for the initial Interest Period has been fixed at 11 1/4% pa and that the interest payable on the relevant interest payment date, October 26, 1984 in respect of US\$100,000 nominal of the Receipts will be US\$5814.06.
April 27, 1984. London By: Citibank, N.A. (CSSI Dept), Agent Bank CITIBANK

TECHNOLOGY

TOY DESIGNERS MAKE PROFIT BY INVENTION IN A CUT-THROAT INDUSTRY

Why success is a good idea

BY PETER MARSH

CHRIS WIGGS and Chris Taylor have nightmares about toys that fall out of bed.

Mr Wiggs and Mr Taylor run a small company in London called Origin Products, which sells ideas to the American toy business.

In the terminology of this industry, products fall out of bed when the toy companies don't like them enough to turn out the items in their thousands—or when the consumer snubs the toys in the shops.

The pair reckon that their schemes don't fall out of bed too often. They say that about 70 per cent of their ideas succeed, a higher percentage than is common in the industry.

This year American manufacturers will sell about \$20m worth of toys that use Origin's ideas, according to the company's estimates.

Origin's biggest success was a puzzle called the Orbit, a hand-sized ball inset with brightly coloured beads that can be moved around. The company sold the design to 12 toy companies around the world. Toy shops in 20 countries sold 2.5m of the puzzles at about \$6 each.

Origin bases its business on massive attention to detail in the stage of the innovation process in which models are built. Mr Wiggs and Mr Taylor reason that toy manufacturers are more likely to accept proposals if they are given an accurate representation of what the item would look like when it is manufactured.

The pair feature in this part of their activities a novel vacuum forming machine that Mr Wiggs developed four years ago. With the device, Origin can turn out plastic moulds for models in a matter of minutes.

In conventional manufacturing industry, to produce moulds of similar quality would require injection moulding (in which plastic is pumped into cavities in metal tools under high pressure) or machining with computerised hand tools.

Both methods are expensive—and, still more to the point, slow. As a result, small companies that quickly need to put an idea into solid form usually



Chris Wiggs and Chris Taylor, directors of Origin Products, with their Orbit Puzzle design sold to 12 toy companies worldwide

have to rely on a small number of badly made models, or possibly none at all.

With the moulding machine, which runs off the mains and turns out plastic items for a few pence, Origin can produce a number of models before it decides on the one to present to a possible customer.

Other tools in Origin's model-making process are manually operated cutting and punching hardware and an electric saw. The staff draws on pieces of paper. There is not a computer in sight.

"We are waiting for computers to catch up with us," says Mr Wiggs. "We haven't seen one for less than £200,000 that is even partially intelligent."

Mr Wiggs, 34, left school at 15 and became an apprentice engineer. He enrolled at an art college and met Mr Taylor, aged 29. At college, the pair formulated a list of 20 ideas which they thought could turn

into saleable products. About five years later, in 1980, the duo met up again and formed Origin. Their general rule is to concentrate on ideas which they then try to sell to manufacturers.

The exception to this is the vacuum-forming machine. Origin not only uses the device itself, but has sold several dozen to a range of customers.

The company's hardware comes in two types. A £950 machine produces plastic items up to 12 inches square and 4 inches deep. A bigger machine sells for £1,450 and turns out products up to 18 inches square and 9 inches deep.

In both versions, a flat sheet of plastic is heated and pressed over a mould of wood or plastic. The user first has to shape the mould, probably with manual tools.

In the next step, a vacuum pulls down the sheet so that it takes up the exact shape of

the solid item underneath. The replication is so accurate that the finished item takes on even the shape of the grains of wood in the mould.

Origin has sold its machines to entrepreneurs that turn out plastic products, sometimes from the kitchens of their homes. With the hardware, other companies have made dispensers for telephone handsets and casings for electronic goods.

Britain's nuclear industry bought a machine to make a model of the pressurised water reactor that the Central Electricity Generating Board wants to build at Sizewell.

"We sell the machines because this keeps us in touch with what industry is doing," says Mr Taylor. "Also we can bring into the toy business new types of plastic that we learn about through vacuum forming."

The working week at Origin's workshop in Notting Hill seldom has a set pattern. Events are

punctuated by minor crises as the staff struggles to meet deadlines imposed by possible customers.

Mr Wiggs says that a flash of inspiration for a new toy may need between 500 and 100 hours of work to turn it into a solid proposal that will appeal to a marketing department of a toy manufacturer.

In this way, for example, Origin sold to the U.S. proposals for three toys that are on sale this year.

Two of the items which incorporate Origin's ideas are miniature cars with novel kinds of steering apparatus and remote-control mechanisms. The third is a badge which features an animated figure.

Mr Wiggs and Mr Taylor do not give away technical details of their ideas. For one thing, on some schemes, the pair are still finalising the patents.

Secondly, the toy market is rife with imitators. Origin spent £25,000 on patent protection for its Orbit. But it could do little to stop "pirated" copies of the puzzle going on sale in the U.S. before the authorised versions.

Failure to meet a deadline—or a toy that "falls out of bed" at a crucial stage—could ease the company out of an important contract.

"If you're a day late—you're a year late," says Mr Wiggs.

The company also suffers from heavy competition. The U.S. contains a couple of hundred design companies such as Origin, according to Mr Wiggs. All are trying to sell ideas to an industry with an annual turnover of some \$12,000m.

"This business suits our way of working," declares Mr Taylor. "It's exciting, immediate and very high pressure. The industry's very brutal—it rewards people who put in the maximum of effort."

What kind of toys will children buy later in the 1980s? Mr Wiggs has lots of ideas but he's not trying what they are. "Knowing where to look is 90 per cent of the battle."

HOSPITAL PROJECTS

Light focused on medical applications

TWO laser companies and a university physics researcher have formed a new venture to make medical lasers. Raymed, based probably in Livingston, Scotland, will turn out carbon-dioxide lasers for gynaecological surgery.

Raymed is a joint enterprise by Lamda Photometrics of Harpenden, Edinburgh Instruments and Dr John Colles, head of the medical laser unit at Herriot-Watt University, Edinburgh.

Lamda Photometrics, which earns some £2m a year by importing lasers into Britain, will own 60 per cent of the new company. Mr Robert Carless, managing director of Lamda, says Raymed hopes to sell about 10 lasers in its first year. Sales should double in 1985.

Raymed will base its devices on lasers produced by Edinburgh Instruments, a company set up 14 years ago by Prof Desmond Wilson of Herriot-Watt University.

The lasers sold by Raymed will include electronic controls and a colposcope. The latter is an instrument that includes a magnifying device with which surgeons can examine the body as they are applying treatment. The complete unit will sell for £15,500.

Over the next few weeks engineers are to install the first two products from the new company. They will be used at Northern General Hospital, Sheffield, and at the Birmingham Midland Hospital.

According to Mr Carless, hospitals in the UK have about 80 carbon-dioxide lasers for medical applications. A large proportion are imports. Virtually all the lasers are for gynaecology—the others are for neurosurgery and treatment of ear, nose and throat ailments.

Carbon-dioxide lasers blast highly-focused energy at diseased tissue. Most of the energy is absorbed by the water which comprises the largest proportion of human cells. As a result, the focused beam acts as a scalpel, removing tissue by vapourisation in a process that is almost bloodless.

But carbon-dioxide lasers cannot be transmitted by optical fibre. So it is impossible to channel with endoscopes light from these devices to sites inside the body. This type of surgery is confined to argon and neodymium/YAG lasers—which do not work as well as the carbon-dioxide devices. This is because their radiation is absorbed less by the water in human tissue.

FORTUNE SYSTEMS
To stay ahead we think ahead
Market leaders in micro technology
01-741 5111

Materials Composite gantries

British Rail is turning to composite materials to replace steel in some of the gantries that it installs alongside railway lines.

The board is to use composites based on glass fibres and coated with resin for gantries that workers will install over the next year in East Anglia. The structures carry electric cables to provide trains with power.

Bristol Composite Materials Engineering, a subsidiary of BP, will make the composites at a factory in Avonmouth. BP says the material has good resistance to corrosion and has a higher strength to weight ratio than steel.

Following five years of trials by British Rail and BCFME, the two groups are also collaborating on using the composites in other railway structures, footbridges and lighting towers, for example.

Union Bank of Switzerland
Notice to Holders of the 5% US\$ Convertible Bonds due May 15, 1989
Union Bank of Switzerland (Panamá) Inc., Panamá

At the Annual General Meeting held on April 5, 1984 the shareholders of Union Bank of Switzerland have approved to increase the share capital from Sfr. 1515 millions to Sfr. 1650 millions. The participation certificate capital will be increased in the same portion.

In conformity with the Terms and Conditions of the Bonds, the conversion price of 15 bearer participation certificates (BPC's) to which one bond entitles will therefore be reduced to

US\$ 963.53

with effect as of April 27, 1984.

Upon conversion of any Bond, there will be paid to the Bondholder in respect of each Bond delivered for conversion a sum in dollars equal to the difference between the principal amount of US\$ 1,150 of such Bond and the new conversion price.

Zurich, April 27, 1984.

Sec. Code No. 804.882

Union Bank of Switzerland

The electronic office is here...

Your chance to grasp its advantages

Telecommunications and computers have made the electronic office a reality. Its benefits to the efficiency and profitability of any business are proven—its potential is bursting to be realised.

Seize your best opportunity to view and assess the practical applications for your organisation—whilst over 400 exhibitors are gathered conveniently under one roof, ready to advise you.

Communications 84
INTERNATIONAL EXHIBITION OF TELECOMMUNICATIONS, RADIO AND INFORMATION TECHNOLOGY, PRODUCTS AND SERVICES.

15-18 May 1984 National Exhibition Centre, Birmingham, England.

Please send me by return post COMMUNICATIONS 84 Visitor Information Pack(s), each with free registration card for the exhibition.

Name: _____
Company: _____
Address: _____

Return to: Dept PS1, Industrial & Trade Fairs Limited, Redcliffe House, Blenheim Court, Solihull, West Midlands B91 2BG, or phone 021-705 6707.

INDUSTRIAL SYSTEMS
Lasers shine with improved sales

SALES of lasers have doubled in Western Europe since 1980 (constant 1982 dollars), in spite of generally difficult economic conditions and a strengthening of the U.S. dollar by 60 per cent against European currencies.

The number of suppliers has gone up by 40 per cent and some laser designs have moved from the experimental to the commercial.

Nine main laser types are being applied to information processing, materials, working/processing, alignment and construction, optical communications, medical work and instrumentation.

In 1983 total sales were just over \$300m, compared with \$217m in 1982 and only \$153m in 1980. Germany absorbed 34 per cent of this total, the UK 24 per cent, and France 19 per cent. In Britain and Germany, foreign distributors (mostly from the U.S.) sold a little more than the indigenous manufacturers, but the makers did some 50 per cent better than the importers in France.

The figures appear in a new survey by Frost and Sullivan which also shows that by value, the carbon dioxide device was the best seller, both as part of complete systems (mainly for cutting) and as a stand-alone device.

But more and more lasers are being sold to end-users within systems instead of as boxed devices. This trend to more OEM business by the laser makers seems likely to continue as new areas, such as optical communications, have arisen in which such companies are finding it difficult to take a direct interest.

There has been some reaction, however, such as Spectra Physics' recent joint venture with Xerox to exploit the lat-

ter's semiconductor laser array technology. F and S asserts that this joint company, Spectra Diode Laboratories, will "be of crucial importance" to the parent and to the industry as a whole.

The reason is that SDL is developing laser diodes and light-emitting diodes fabricated by a metal-organic chemical vapour deposition method pioneered at Xerox. The technique has already been used to produce laser diode arrays of up to 40 elements with a 2.5 watt output, yet small enough in size to be used in fibre optic communications.

However, F and S concludes that Spectra Physics "would be unwise to rely entirely on this new venture to lift itself from the period of sales stagnation and falling profits which it has endured since 1980."

In contrast, F and S says, its principal competitor, Coherent, has been able to maintain sales growth since 1980. At \$91m in 1983, of which 40 per cent was accounted for in Europe, Coherent is, says F and S, "on level footing with Spectra Physics for the first time in Europe."

At the "power" end, carbon dioxide remains the most formidable—experimental and military types have achieved 100 Kw (continuous) and 450 Kw pulsed. The military significance of this can be imagined—it is the equivalent to the heat of 100 one-bar electric fires concentrated into a beam perhaps less than an inch across.

But as a weapon, laser devices suffer from beam divergence—much work is on progress on beam quality.

"The Commercial and Industrial Laser Market in Western Europe," Frost and Sullivan, 104 Marylebone Lane, London, W1M 5E6 (01-486 8377).

Some people buy Florida real estate to hold for the future others buy to enjoy it now.

Whether you are thinking of Florida for your future — Or as a place to live now, The Deltona Corporation can tailor a real estate plan to suit your needs.

Condominiums on the beach...
Single-family homes on wooded homesites, an apartment for vacations or land to hold for the future are all a part of Deltona's offerings. And, you can choose from several rapidly growing areas in Florida with prices from \$6,995 to \$300,000, with excellent financing available.

The Mackle family...
who heads the 300 million dollar Deltona Corporation have over 75 years of building and real estate experience. They are known the world over for their high degree of integrity and for helping others achieve their Florida dream.

If you have ever thought about living in Florida...
Or sharing in its phenomenal growth then be sure to contact The Deltona Corporation. They have opportunities that may be beneficial to you.

Send for brochures and details today.

The Deltona Corporation
3250 S.W. Third Avenue Miami, Florida 33129

Yes, I'm interested in Florida real estate opportunities. Send me information on:
 Beach Condominiums
 Vacation Opportunities
 Single-Family Homes
 Homesites (Land)

Name: _____ Country: _____
Address: _____
City: _____
Telephone: _____

Deltona
Members, New York Stock Exchange.

The Best Last Flight To New York Is Back.

Now European business travellers have got something to celebrate. Pan Am's 19.00 flight from London to New York is back. As it leaves Heathrow at the end of the day, it's an easy connection from most European cities. First and Clipper® Class passengers can still enjoy the free refreshments in our 'New York' lounge at Heathrow, and reserve a free limousine into Manhattan.

Contact your Travel Agent or your nearest Pan Am office.

Pan Am. You Can't Beat The Experience.

UK COMPANY NEWS

Blue Circle moves up to £109.5m

Blue Circle Industries, the UK's largest cement manufacturer, made up the midway profits shortfall of £3.3m in the second half of 1983, to finish the year with pre-tax profits ahead of a restated £107.5m to £109.5m. Turnover increased by £121.3m to £906.5m. However, after a tax charge £8.8m higher at £29m, earnings per £1 share were down from 88.1p to 82.9p. Despite this, the final dividend is raised by 0.75p to 13p net for a total payment up from 18.25p to 19p. Following a change in accounting policy, 1982 figures have been restated to exclude additional depreciation taking account of inflation since the last revaluations of tangible fixed assets. This change had the effect of increasing reported pre-tax profits by £20.9m (£17.5m in 1982).

The directors reported that the year 1983 was characterised by the group's entry into the U.S. cement and concrete industry, expansion in the UK by the acquisition of Aberthaw Cement and the continuing modernisation of UK cement plants. As a result of this expenditure, net interest charges more than doubled to £21.4m (£10.3m).

A geographical analysis of pre-interest operating profits shows—UK £58.2m (£52m) or 44 per cent (same); Australasia £11.3m (£11.7m) or 8 per cent (10 per cent); Africa £31.6m (£32.2m) or 24 per cent (27 per cent); U.S. £9.5m (£0.5m) or 7 per cent (—); Latin America

HIGHLIGHTS

Lex looks at the first quarter figures from ICI where profits of £245m are well up to anything the market was looking for. This may provide ammunition for the cynicism that has troubled the shares since the beginning of the year. Lex then goes on to comment on the results of House of Fraser where the profits that can be more than explained by the Christmas bombing. The column then turns its attention to the wider aspects of the building industry where there were results from Blue Circle and Wimpey. Both have come up with more or less unchanged profits while echoing each other's thoughts on the declining returns from developing countries and the need for U.S. expansion. Finally Lex comments on the complicated \$800m issue by the Kingdom of Sweden.

£7.5m (same) or 6 per cent (7 per cent); Asia and Middle East £15.4m (£14.2m) or 11 per cent (12 per cent).

After all charges, retained profits were down sharply from £69.9m to £18.6m. This reflected extraordinary debits of £9.8m (£17m credits) and a £20m transfer to deferred tax this time—as a result of the proposed reduction in the rates of UK capital allowances and in the rate of corporation tax.

The extraordinary items comprised a £2.5m provision in respect of two cement works and a gypsum quarry which will be closed in 1984; an £8m provision against the Indonesian investment; less £0.7m net profit on the sale of investments.

Profits were 12 per cent higher in the UK due mainly to the contribution from Aberthaw Cement arising from the acquisition of the outstanding 74 per cent of that company and excellent progress by Armitage Shanks, the directors state. UK deliveries of cement (including Aberthaw for the full year) amounted to 7.98m tonnes.

The price of cement remained unchanged throughout the year apart from some reductions in Northern Ireland to meet competition from imports. Inflationary increases in costs have been counteracted by improvements in efficiency. These have, however, involved redundancy costs of £2.7m which have been shown as an exceptional item.

Operating profits from Armitage Shanks—maker of bath room products—rose from £8.1m to £11.1m, of which £7.8m

ICI leaps by £117m in first quarter

FOR THE first three months of 1984 pre-tax profits of Imperial Chemical Industries totalled £245m.

This was an improvement of £71m on the figures of the preceding quarter and a rise of £117m on the £128m reported for the opening three months of 1983.

The directors say the improvement arose mainly from higher sales volumes at better margins.

All major business sectors operated profitably and all performed better than during the previous quarter, with the improvement being mainly in Western Europe. Profits outside Europe were little changed.

Particularly good results were achieved in pharmaceuticals and agriculture and further improvements were made in the commodity chemicals businesses.

Group turnover for the first three months of the current year amounted to £237bn (£240bn) and consisted of chemicals—UK £588m (£533m) and overseas £1.48bn (£1.27bn) and oil £305m (£218m).

Sales volumes and prices both increased by 3 per cent with exchange effects accounting for a remaining 1 per cent. Chemical exports from the UK at £532m, were 26 per cent higher than in the fourth quarter.

The group's oil business produced trading profits of £31m in the first quarter of 1984, compared with £20m for the fourth quarter of 1983, after PRT of £52m (£31m).

The tax charge, which included all taxes, amounted to £90m (£45m) for the corresponding months of 1983) comprised £66m (£36m) of UK corporation tax and £24m (£13m) tax of overseas subsidiaries and principal related companies.

UK corporation tax was provided at 46.25 per cent, the expected average rate for the accounting year 1984.

Pre-tax profits for the first three months were struck after £20m (£17m) depreciation of £107m (£105m). Attributable profits emerged £72m ahead at £146m and earnings rose by 11.9p to 23.9p per £1 share.

Group pre-tax profits for the 1983 year more than doubled to £615m.

See Lex

George Wimpey off £0.7m after second half fall

A DOWNTURN of £2.7m in second-half profits of George Wimpey has left this construction engineer just behind for the year 1983 at £45m pre-tax, compared with £45.7m.

Turnover for the 12 months amounted to £1.48bn, against £1.24bn, including £822m (£718m) from the UK.

Mr C. J. Chetwood, chairman and chief executive, says, however, that despite many difficulties and continuing low economic activity in the UK, operating profits were maintained at £36.8m (£36.7m). "This is a good result in the circumstances. The group's financial position remains strong."

Above the line, exceptional losses of £11.7m were more than offset by exceptional profits for the period of £2.1m, associated losses amounted to £0.1m (£0.8m profit), and net interest payable was slightly higher at £1.1m (£1.0m).

Earnings per 25p share were 18.2p (18.7p) and the dividend is effectively lifted to 3.05p (2.78p adjusted) with a final distribution of 2.2p.

The exceptional profits for the year were those realised on the disposal of the group's interest in Euston Centre Properties and eight other property companies—revaluation reserves of £41.5m have been realised on these disposals.

The exceptional losses for the period arose from a contract to construct a hydro electric scheme in Swandun, amounting to £9.6m; the cessation of a joint

venture high rise residential property development in central Hong Kong costing £9.2m; losses totalling £22.9m on the group's 49 per cent interest in an electrical and mechanical engineering company in Saudi Arabia which is in financial difficulties.

Results in the housing sector started to improve, the chairman says in 1983 and the upward trend continued during 1983 with 9,330 house sales legally completed.

Mr Chetwood explains that

the group has "restructured to offer a total capability in the sectors of energy and process engineering."

The chairman says he is particularly pleased with the group's progress in the U.S. Apart from 850 house sales in Texas last year, directors have also established a "significant presence" in the Californian homebuilding market with the Morrison Homes acquisition.

Wimpey's wholly-owned investment programme was strengthened during 1983 and net rental income rose by £2.3m to £8.5m, while rent reviews caused by underway may further increase income during 1984.

Mr Chetwood believes there is ample scope to build on the group's underlying financial strength and strong position in a number of markets.

Tax charge amounted to £7m (£7.4m), minorities £0.9m (£0.3m credits) and after an extraordinary debit of £11.2m—the attributable balance came through down from £38.6m to £25.9m. Dividends will absorb £8.6m (£7.7m).

See Lex

Dividends announced are on Page 24

Mr Chetwood explains that

Farnell hoists profits and dividend by 50%

Farnell Electronics, the electronic component distributor and maker of power supplies, hoisted pre-tax profits by over 50 per cent from £10.4m to £15.7m in the year ended January 29 1984. Turnover increased by nearly 40 per cent to £82.86m, against £44.92m.

A final dividend of 1.5p (1.25p) net lifts the total payment by 50 per cent from 2p to 3p. Earnings per 5p share climbed from 8.5p to 13.1p. A one-for-one scrip issue is also proposed.

After tax of £7.65m (£5.18m) and minorities of £2.00m (£3.00m), net profits were ahead from £5.26m to £8.16m. The dividend amounts to £1.57m (£1.24m), leaving a retained balance of £6.25m, against £4.02m.

A divisional analysis of turnover and pre-tax profits shows respectively (with 000s omitted): electronic component distribution £28.84 (£27.41) and £10.87 (£7.19); electronic manufacture and marketing £20.18 (£13.91) and £4.03 (£2.15); consumer goods distribution \$4,356 (£3,967) and £12 (£4); other profits including parent company, £86 (£1.93).

Trading profits rose from £9.19m to £14.77m after charging £388,000 (£390,000) for the

employee profit-sharing scheme and £150,000 "topping-up" payment last time to the trustees of the pension scheme. Other income added £1.02m (£1.25m).

comment

Farnell Electronics came through the recession reasonably unscathed, doing impressively well whilst there is the current strong demand for components. The market has recognised the strengths of the company (efficiency, steady growth in margins, a wide spread of customer) and the shares have accordingly commended a premium rating. There is only limited scope for further improvements in efficiency and the same strong growth in manufacturing is not expected to be repeated in the current year. So, profits growth will depend largely on volume gains. Nevertheless, Farnell should manage to increase turnover by a third and push pre-tax profits up around the £20m mark. That puts the shares, up 5p yesterday, at 433p on a p/e of 24.5, fairly valued for the present, though Farnell should share in any further gains made by the sector as a whole.

Better first quarter for Vickers

Vickers, the engineering group which makes Rolls-Royce cars, said yesterday its financial position in first quarter 1984 had shown an encouraging improvement over the same period of 1983.

In 1983 the group's profits were achieved mainly in the second half of the year. First half profits fell 28 per cent to £7.5m but the full year pre-tax result was £19.5m, virtually unchanged on 1982's £18.6m.

Chairman Sir Richard Cave, told the annual meeting that in the UK, "I have been encouraged to see that there are clear signs that the recovery is continuing and in some cases, business is at a higher level than planned."

In the annual report earlier this month, the directors had said economic recovery was likely to be patchy.

Mr David Plastow, managing director and chief executive, said after the meeting that sales of Rolls-Royce cars in the U.S., the major market for the vehicle, were going well.

Exports help boost Laporte to £30m

A JUMP of 50 per cent in pre-tax profits has been shown by Laporte Industries (Holdings) for the year to the end of January 1984 and Mr R. M. Ringwald, chairman, says that the current year has shown a "very encouraging" start.

Pre-tax profits rose from a restated £20.12m to £30.23m for the year following a rise of £4.14m to £13.71m at the halfway stage.

The net final dividend has been raised from 5.25p to 6.5p which lifts the total from 8.75p to 10.5p. Earnings per 50p share rose from 18.5p to 23.7p.

The dividend will be paid on capital increased by a rights issue last year, and the payment is an improvement on the forecast made then of a not less than maintained total for the year. A 1-for-2 scrip is also now proposed.

Mr Ringwald says the improved results were due to three main factors: better performance in the UK as a result of increased exports, rising contribution from companies newly acquired by Laporte and, to a smaller extent, interest from the

proceeds of the rights issue in the second half of the year.

Cash performance was much improved, with a net inflow for the year of £6m in addition to £20m raised by rights. The year-end net borrowings of the group were reduced to £7m.

Group sales of this maker of speciality chemicals, for the year, including the attributable share of the related Interco principal companies, advanced from £240.87m to £290.25m. At the halfway stage the directors said that one of the highlights of the opening half had been that the Interco operation in the U.S. had begun producing a cash surplus on its revenue account.

A breakdown of turnover and profits by geographical area shows: UK £133.91m (£111.51m) and £16.32m (£10.29m); Australasia £36.82m (£33.15m) and £1.54m (£2.59m); other overseas subsidiaries £11.2m (£11.72m) and £32,000 (losses £237,000). The total turnover figure also included £93.44m (£84.46m) from the Interco principal companies attributable share.

After lower interest payments

of £1.89m against £3.14m, the share of results from Interco related companies grew from £10.11m to £13.19m. Other related companies contributed £730,000 (£507,000).

Tax charge amounted to £11.96m against £3.05m, including £7.71m (£6.16m) for related companies. Extraordinary debits came to £2.31m (credits £79,000) including a £2.48m provision for deferred taxation.

At the attributable level the balance increased from £11.11m to £15.96m, from which dividends will absorb £7.12m (£5.1m). The transfer to reserves is up from £3.01m to £5.83m.

The directors say that results for 1982 have been restated in line with the new accounting standard on foreign currency translation.

On a current cost basis pre-tax profit came to £20.01m (£11.3m) and earnings per share to 12.6p (3.7p).

These results confirm how attractive Laporte will look once the £90m deal to sell its titanium dioxide business is completed. It is not that this division is doing badly — it made increased profits last year — but the cash released will cut Laporte's links with cyclical commodity chemicals and allow it to concentrate further on its portfolio of speciality companies. With year-end borrowings only £7m, there is already plenty of scope for more growth by acquisition. No breakdown is given of the performance of the existing largely UK-based speciality companies—though all are said to be profitable and benefiting particularly from export growth. The other major arm of Laporte, the Interco business, jointly owned by Solvay, gained ground from sharply increased sales, but the new venture in the U.S. is still to break into profit. In the current year, interest earnings should replace titanium dioxide profits, and overall the group should make £42m pre-tax. The shares, up 12p at 488p, trade at a prospective multiple of just under 12, on a 40 per cent charge, somewhat cheaper than other speciality chemical stocks.

See Lex

ABRIDGED PARTICULARS

Application has been made to the Council of The Stock Exchange for the grant of permission to deal in the Ordinary Shares of E. T. Sutherland and Son PLC in the Unlisted Securities Market. It is emphasised that no application has been or is to be made for these securities to be admitted to listing. This advertisement does not constitute an offer or invitation to subscribe for or purchase shares.



E.T.Sutherland and Son PLC
(Incorporated under the Companies Act 1983; number 298325)

OFFER FOR SALE
by
SAMUEL MONTAGU & CO. LIMITED
of
3,750,000 Ordinary Shares of 25p each at 95p per share payable in full on application

SHARE CAPITAL

Authorised	Issued and now being issued fully paid
£4,500,000	Ordinary Shares of 25p each £3,750,000

The Company manufactures an extensive range of quality chilled fresh foods including meat and fish spreads, pastry products and cooked meats for slicing. These products, together with a variety of complementary chilled foods bought in from other manufacturers, are marketed principally under the Sutherland brand name and distributed mainly by the Company's van sales force. The Company also produces a range of quality canned foods, including meats, soups and ready meal products, mostly for sale to retailers and wholesale distributors under their own label brand names.

Full details of E. T. Sutherland and Son PLC and of this Offer for Sale, together with an Application Form, are contained in the Prospectus (on the terms of which alone applications will be considered) copies of which may be obtained from:

Samuel Montagu & Co. Limited 114 Old Broad Street London EC2P 2BY	E. T. Sutherland and Son PLC Waleswood Food Factory Kiveton, Sheffield S11 9PF	Seringhouse, Kemp-Coo & Co. 20 Copthall Avenue London EC2R 7JF
---	--	--

and from the following branches of Midland Bank PLC

Stock Exchange Services Department Mariner House, Peppes Street, London EC3N 4DA	130 New Street Birmingham B2 4JU	1 Saddler Street Dunham DH1 3NR
33 Park Row Leeds LS1 1LD	4 Dale Street Liverpool L8 2EZ	100 King Street Manchester M60 2HD
42 Gray Street Newcastle NE99 1MD	17 Church Street Sheffield S1 1HX	680 Stanfield Road Darvall Sheffield S9 4TQ

Particulars of the Company are available in the Extra Statistical Services.
The Application List for the shares now offered for sale will open at 10.00am on Thursday 3rd May, 1984 and may be closed at any time thereafter.

COMPANY NEWS IN BRIEF

Pre-tax profits of Whatman Reeve Angel, laboratory supplies manufacturer, expanded from £2.52m to £3.47m for 1983 and earnings are based from 7p to 7.5p net per share with a final payment of 5.1p.

Turnover amounted to £23.92m, against £19.43m and the pre-tax figure was also increased payable of £208,000 (£244,000), and £139,000 (£90,000) for the employee share participation scheme.

Earnings per 25p share are given as 38.87p (38.01p) basic and 37.66p (37.09p) fully diluted after tax £1.79m (£1.32m).

Directors say the outlook for the group remains promising.

Net asset value per share at Fleming Universal Investment Trust improved from 284.3p to 333.9p in the year to March 31, 1984. Earnings per share were slightly lower at 6.6p compared with 6.8p. The final dividend is unchanged at 4.75p net for a savings total of 4.75p.

Gross income for the year was £2.55m (£2.52m). Expenses were up from £136,000 to £141,000, interest charges rose from £14,000 to £109,000, and tax was down to £252,000 against £286,000, leaving revenue available at £1.47m (£1.52m). Attributable profits came out at £1.44m (£1.48m).

SFP, a pump manufacturing group acquired by its management and financial institutions team Swaker, Metropolitan last October, lifted pre-tax profits in 1983 to £1.1m, compared with £980,000. Turnover was £26m against £25m.

Higher full-year taxable profits of £106,000, against £85,000, were attained by H. C. Silingsby, a Yorkshire-based truck and ladder manufacturer.

Turnover for the 12 months to end-December 1983 rose from £3.17m to £3.91m. The taxable result was struck after interest of £30,000 (£13,000).

Silingsby has close company status and is holding the year's payout at 2.4p with an unchanged final of 1.8p. After tax of £27,000 (£28,000) earnings per 25p share on a nil basis were 10.5p (8.5p), or 7.5p (5.5p) on a net basis.

The directors have felt it prudent to write-off a proportion of ACT in the accounts, but point out that this amount is available to be recovered against future taxable profits.

On a CCA basis profits were reduced to £39,000 (loss £22,000).

Mr Bill Rooney, chairman of USM company Spring Ram Corporation, told the AGM that first quarter results were well ahead of those of the comparable period of 1983 and that with buoyant trading conditions in the home improvement industry and healthy order books he viewed 1984 with confidence. To facilitate future development a £5m capital spending programme has been launched. The group intends

to seek a full listing within a year. It is currently capitalised at some £20m.

Mr Peter Meyer, chairman of Federated Housing, told the AGM that on present estimates group sales for 1984 should rise by 60 per cent. He said this was exceptional but that it mainly reflected the deal earlier this year whereby Federated took over Crouch Homes' housing stock and undertook to develop it.

Estates & Agency Holdings, property investor, achieved higher profits after tax of £280,801 against £228,822 for 1983. Earnings per 25p share came to 4.63p compared with 3.75p and the dividend for the year has been lifted from 2p to 3p.

Net assets per share came to 213p against 190p. The company is a subsidiary of Rosdiamond Holdings.

A Guide to Financial Times Statistics

New 1984 Edition

Price: £9.50 UK or £11/US\$19 overseas

Prices include postage and packing.

Available from: The Market's Dept. Financial Times Business Publishing, 102 Clerkenwell Road, London EC1M 5SA. Tel: 01-251 9321. (Mail order address only).

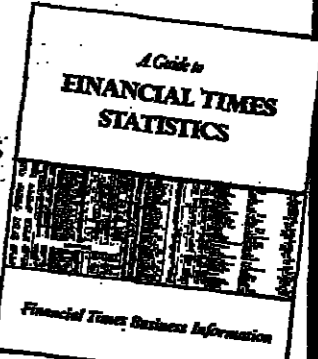

Who are the UK's No.1 concrete faced brick producers?

Using some of the most modern plant in the world, Edenhall Concrete Products Limited, together with its associated companies in the London and Northern Group have an annual production capacity of 180 million concrete facing bricks, making Edenhall the UK's biggest producer.

Other London and Northern names equally notable in their fields include Weatherseal Windows, pioneers and innovators in domestic double glazing; Blackwell Tractor Shops, operators of Britain's biggest and most modern specialist heavy earth-moving fleet; Pauling, established in overseas civil engineering for over 100 years; Steel Stockholders of Mossend, Lanarkshire, the largest steel profiler in the UK and possibly Europe; and now, United Medical Enterprises, a major force in world healthcare services.

Send for the latest Report and Accounts to find out more about London and Northern, a Group with £226m turnover in 1982, which has increased or maintained its dividend for eighteen years — every year but one since going public in 1963.

London and Northern Group PLC, Essex Hall, Essex Street, London WC2R 3JD. Telephone: 01-836926L.



Construction, Healthcare — and much more besides.

Fraser lifts profits 25% to over £38m and pays 1p more

PROFITS, before tax, of House of Fraser department store operator which owns Harrods, expanded by 25 per cent from a restated £30.88m to £38.78m for the year ended January 28 1984, on total turnover of £966.90m, against £879.73m, a rise of 9 per cent. VAT took £115m (£105.9m).

Current sales are ahead of this time last year and of internal budgets and profitability at the half year should continue to show an improving trend, the directors state. The directors point out that the impact of the Harrods and Oxford Street bombings upon all of the group's London stores at the peak Christmas and Sales period.

After tax, earnings per 25p share advanced by 32 per cent from 14.3p to 18.9p and with final payment of 6p (5.5p) the total dividend is stepped up to 24.9p (23.8p).

Three unprofitable stores were closed during the year, significant changes were made in administrative structures and staff numbers were reduced by 5 per cent, resulting in a 15 per cent increase in staff productivity, the directors point out.

Harrods increased its profit to record levels and the profitability of the rest of the Fraser stores showed a marked upturn, the directors state.

The Harrods major development programme added 40,000 sq ft of selling space to the Knightsbridge store, while many areas were redesigned, including the food halls.

New store designs for merchandise presentation were introduced at D. H. Evans, Oxford Street, Kendal Milne's, Manchester, in Sunderland, Dicks and Jones, of Regent Street and Frasers of Glasgow. Fourteen new Life-style departments, selling merchandise aimed at younger people, have been opened in the larger stores, directors state.

Pre-tax figures was after interest of £3.36m (£3.6m) and a £1.5m (£1.5m) allocation to a profit-linked share plan. After tax, an extraordinary dividend of 999,000 (£791,000 credits) is available for shareholders, compared with £22.85m, compared with £22.85m. Dividend will absorb £13.04m, against £11.45m.

BOARD MEETINGS

The following companies have notified dates of board meetings to the Stock Exchange. Such meetings are usually convened for the purpose of considering dividend proposals and the directors are shown below on a basis mainly on last year's timetable.

TODAY
Investment: Aberdeen Trust, Loveland Investment, North Sea Assets, Scot. Investment, Authority Investments, Henry Boot, River, Guyton Son, Drenth, Brea, Flight Refuelling, Hopkinson Holdings, Rock, Southlight Services.
FUTURE

Aradon: May 2
Balfour Beatty: May 2
Davenish (L.A.): May 24
Frasers: May 24
Satchi and Satchi: May 1
Valis Breweries: May 10
Windsor Securities: Apr 30
Finals:
Barwood: May 4
Devises and Newman: May 1
Demand Stamping: May 24
Miles: May 1
Sesombo Marshall & Campion: May 15
Sheepco: Pas Rubber Issues: Apr 30
Wilson Investment: May 15
York Mount: May 2

Interest of £3.36m (£3.6m) and a £1.5m (£1.5m) allocation to a profit-linked share plan. After tax, an extraordinary dividend of 999,000 (£791,000 credits) is available for shareholders, compared with £22.85m, compared with £22.85m. Dividend will absorb £13.04m, against £11.45m.

Within the extraordinary items was a £30.38m provision for additional deferred tax, which was met by a transfer from reserves of the same amount, while the other items included the surplus on sale of properties, less closure costs, and the costs of the Harrods demerger proposals.

As at January 28 last the group balance sheet shows total assets at £756.8m and shareholders' funds of £479.8m. Net current assets increased by £19.7m during the year. Total net borrowings amounted to £98m at the year end, equivalent to 20 per cent of shareholders' funds.

Within the extraordinary items was a £30.38m provision for additional deferred tax, which was met by a transfer from reserves of the same amount, while the other items included the surplus on sale of properties, less closure costs, and the costs of the Harrods demerger proposals.

As at January 28 last the group balance sheet shows total assets at £756.8m and shareholders' funds of £479.8m. Net current assets increased by £19.7m during the year. Total net borrowings amounted to £98m at the year end, equivalent to 20 per cent of shareholders' funds.

Within the extraordinary items was a £30.38m provision for additional deferred tax, which was met by a transfer from reserves of the same amount, while the other items included the surplus on sale of properties, less closure costs, and the costs of the Harrods demerger proposals.

As at January 28 last the group balance sheet shows total assets at £756.8m and shareholders' funds of £479.8m. Net current assets increased by £19.7m during the year. Total net borrowings amounted to £98m at the year end, equivalent to 20 per cent of shareholders' funds.

EIS rises to £3.6m as demand holds up

DEMAND WAS sustained in the second half of EIS Group, enabling the company to report record pre-tax profits, up by 14.7 per cent from £3.16m to £3.62m, for the year 1983.

And the directors are proposing to increase the final dividend from 3.3p to 3.85p, to lift the total by 10 per cent to 8.5p. Group turnover rose by more than 20 per cent from £30.63m to £37.3m, with a strong performance by the process plant and machinery division, with sales up 47.5m to £19m. Aircraft engineering experienced a slight decline in sales, to £7.7m, against £8.64m.

Profitability was maintained despite the difficult market conditions prevailing in the capital goods industries, the board states. A breakdown of taxable profit shows an improvement in all divisions. Process plant and machinery £1.5m (£0.9m); hydraulics and precision engineering £1.02m (£1m); aircraft engineering £745,000 (£741,000). Interest cost £303,000 (£431,000).

Although there are still no reliable signs of overall improvement in trading conditions, current orders are up by 20 per cent to total £28m. This is before taking into account the order book of the recently acquired Northampton Machinery.

Tax took less at £515,000, against £782,000.

Within the extraordinary items was a £30.38m provision for additional deferred tax, which was met by a transfer from reserves of the same amount, while the other items included the surplus on sale of properties, less closure costs, and the costs of the Harrods demerger proposals.

As at January 28 last the group balance sheet shows total assets at £756.8m and shareholders' funds of £479.8m. Net current assets increased by £19.7m during the year. Total net borrowings amounted to £98m at the year end, equivalent to 20 per cent of shareholders' funds.

Within the extraordinary items was a £30.38m provision for additional deferred tax, which was met by a transfer from reserves of the same amount, while the other items included the surplus on sale of properties, less closure costs, and the costs of the Harrods demerger proposals.

As at January 28 last the group balance sheet shows total assets at £756.8m and shareholders' funds of £479.8m. Net current assets increased by £19.7m during the year. Total net borrowings amounted to £98m at the year end, equivalent to 20 per cent of shareholders' funds.

Minet provides an extra £4.5m for 'PCW affair'

DESPITE TRADING conditions in the world insurance markets remaining difficult Minet Holdings pushed its pre-tax profits up to a record £29.39m in 1983, an improvement of 18 per cent over the £17.8m returned the previous year.

The group also discloses that a further provision of £4.5m was made in connection with the "PCW affair". As anticipated at the time of the interim statement, the rate of growth was lower in the second six months. The results for this period were adversely affected by a review, shortly to be completed by Richard Beckett Underwriting Agencies (formerly PCW Underwriting Agencies) of the various syndicates under its management.

It has formed the view that the members of those syndicates will face substantial underwriting deficiencies and accordingly, it was found necessary to reverse the profit commission incorporated in the first half results.

This involved a reduction of £1.6m in the group's pre-tax profits. Without this adjustment Minet would have reported a 24 per cent increase in profits, which would have been virtually in line with directors' expectations at midyear.

(Referring to the Richard Beckett Underwriting Agencies) the directors say: "The PCW affair has continued to involve a considerable amount of management time and expense.

Our own investigation is now nearing completion and, to date, it has not been possible to publish a great deal of information regarding this affair, due to the sensitive nature of the matters under investigation, and the legal issues involved. Our investigation has been carried out in parallel with those initiated by the Department of Trade and Lloyd's. We have co-operated fully with those inquiries.

"The problems in the underwriting agency arose from various reinsurance arrangements which were made during the period 1970 to 1982 in connection with Syndicates, for which underwriting was arranged by PCW and its associated company, WMD Underwriting Agencies. The reinsurance programmes were extremely complicated and involved the formation of over 150 companies and trusts in at least seven different countries.

"Our investigation shows that various former directors of the agency, together with other individuals, derived an improper personal benefit from these arrangements and legal proceedings have been commenced against them.

"Our investigation has revealed that net reinsurance premiums equivalent to £38.9m were involved. The investigation (10.46p) per 20p share and a secured assets valued at approximately £28.2m controlled from Gibraltar. We are strenuously

pursuing the recovery of this money. Furthermore, negotiations are taking place with various parties with the objective of returning the balance at the earliest possible moment.

"Your group has continued to provide substantial financial and administrative support to the agency company. At the end of June 1983 we had incurred costs and made provisions totalling £2.2m. Following a detailed review of the current situation, a further charge has been made of £4.5m.

The directors say, however, that they are firmly of the view that the total extraordinary item amounting to £6m charged in the group's financial statements in 1982 and 1983 should be the maximum cost to conclude this affair.

They face 1984 with confidence. Group turnover for 1983 rose from £55.47m to £63.02m.

A divisional breakdown of the pre-tax result, which was favourably affected by currency movements to the extent of £2.8m (£1.9m), shows: broking £18.07m (£13.94m), underwriting £1.87m (£1.42m), Lloyd's £2.72m (£2.65m) and other activities £105,000 (£133,000 loss). Group services net expenses took £499,000 (added £337,000).

Earnings amounted to 12.35p (10.46p) per 20p share and a final dividend of 2.45p (2.1p) lifts the total from 4.65p to 5.18p net.

main operating areas, the results nonetheless show that our operations remain strong. Fortunately by the standards of other leading banking groups around the world our exposure to the difficulties of sovereign debt is comparatively small.

The Hang Seng Bank has again produced good results and undertook a significant role in supporting industrial sectors in a difficult period. Our Area Office China was closely involved in the increasing commerce between Hong Kong and The People's Republic of China, and our close association with China over more than a century is an established asset.

Marine Midland Bank reported income growth of 16.2 per cent which brought profits in 1983 to just over US\$100 million; our partnership constitutes a source of real strength to both banks. The British Bank of the Middle East again reported increased results, despite the drop in Middle East oil revenues and region-wide political problems.

HongkongBank opened further branches in various centres, as far apart as Valparaiso and Leeds. The representative office in Taiwan has now been upgraded to full branch status.

In the first half of 1984 we plan to open a representative office in Stockholm, the first permanent presence for the group in Scandinavia.

Merchant Banking
Our merchant banking operations had a difficult year, affected both by adverse conditions in the world markets and by some local problems. These adversely affected the performance of Wardley Limited in Hong Kong in the first half of the year. However, developments in the second half of the year have struck a more positive note. Wardley Australia had a particularly good year. Wardley Middle East and Equator Bank Ltd continued to expand their operations and contacts in the markets of the Middle East and independent Africa respectively.

Finance and Investment
Greenville Transportation Holdings Ltd, which holds our transportation portfolio, produced very satisfactory results. Our hire-purchase and finance companies in Hong Kong, Brunei, Malaysia, Singapore and the Middle East all reported satisfactory results.

Insurance
The Carlingford and Gibbs Insurance Groups continued their expansion, both geographically and in services. The cross-marketing of group capabilities is gaining wider recognition for the group's insurance strength.



WE, THE LIMBLESS, LOOK TO YOU FOR HELP

We come from both world wars. We come from Korea, Kenya, Malaya, Aden, Cyprus, Ulster and from the Falklands. Now, disabled, we must look to you for help. Please help by helping our Association.

BLESMA looks after the limbless from all the Services. It helps to overcome the shock of losing arms, or legs or an eye. And, for the severely handicapped, it provides Residential Homes where they can live in peace and dignity.

Help the disabled by helping BLESMA. We promise you that not one penny of your donation will be wasted.

Donations and information: The Chairman, BLESMA, Midland Bank Ltd, Department FT, 60 West Smithfield, London EC3A 9DX

BLESMA
BRITISH LIMBLESS EX-SERVICE MEN'S ASSOCIATION

The Lombard 14 Days Notice Deposit Rate is **83%** per annum

The Lombard Cheque Savings Rates are **81%** per annum

84% per annum (When the balance is £2,500 and over)

61% per annum (When the balance is £250 to £2,500)

Lombard North Central 17 Bruton St, London W1A 3DH
For details phone 01-409 3434 Ext 484

UBM surges past £10m and says 1984 bodes well

THE LAST two years have seen a "remarkable turnaround" at UBM Group and the current year "bodes well" for the company, the directors state.

From the £2m loss incurred in 1981-82, UBM achieved taxable profits of £2.66m a year later and now reports £10.21m in the 12 months to end-February 1984.

The surge was aided by younger directors forecast of £10m made at the interim stage, when profits were £4.61m, considerably higher than the £255,000 earned in the comparable period.

All UBM's major activities contributed to the increase. Building supplies contributed £3.27m more to £5.47m and glass activities profits were nearly tripled at 1.63m (£55,000).

Elsewhere, motors earned £1.46m (£860,000), scaffolding £701,000 (£354,000), Neiman-Road £1.24m (£354,000) and other activities made £118,000 (£18,000).

Total group turnover expanded from £306.13m to £321.13m and trading profits more than doubled to £11.55m (£5.44m).

The taxable result was enhanced by a £1.42m cut in interest payable to £1.34m. Net borrowings were cut by £10m to £2.98m at the year end.

As forecast with earnings higher at 10.9p (2.2p) per 25p ordinary share the final dividend is hoisted to 4p (1.2p), nearly trebling the total payout to 6.5p (2.2p).

Net profits came out at £6.74m, against £1.66m, after tax of £3.47m (£1.3m). Below the line there was an extraordinary debit of £183,000 (credit £1.03m) which incorporated the cost of the Norcross bid defence. Minors were £302,000 (£186,000).

comment
The attentions of a predator concentrate the mind wonderfully. Certainly, UBM was well on the path to recovery before the Norcross bid last year, but the unwelcome approach created a new sense of urgency, especially since Norcross retains a 37 per cent stake and will be in a position to renew its attack this autumn. These figures reflect the success of an all-round overhaul, yielding better margins on a slightly higher turnover.

Against £2m loss in last year, but the unwelcome approach created a new sense of urgency, especially since Norcross retains a 37 per cent stake and will be in a position to renew its attack this autumn. These figures reflect the success of an all-round overhaul, yielding better margins on a slightly higher turnover.

Against £2m loss in last year, but the unwelcome approach created a new sense of urgency, especially since Norcross retains a 37 per cent stake and will be in a position to renew its attack this autumn. These figures reflect the success of an all-round overhaul, yielding better margins on a slightly higher turnover.

Against £2m loss in last year, but the unwelcome approach created a new sense of urgency, especially since Norcross retains a 37 per cent stake and will be in a position to renew its attack this autumn. These figures reflect the success of an all-round overhaul, yielding better margins on a slightly higher turnover.

Against £2m loss in last year, but the unwelcome approach created a new sense of urgency, especially since Norcross retains a 37 per cent stake and will be in a position to renew its attack this autumn. These figures reflect the success of an all-round overhaul, yielding better margins on a slightly higher turnover.

Against £2m loss in last year, but the unwelcome approach created a new sense of urgency, especially since Norcross retains a 37 per cent stake and will be in a position to renew its attack this autumn. These figures reflect the success of an all-round overhaul, yielding better margins on a slightly higher turnover.

Against £2m loss in last year, but the unwelcome approach created a new sense of urgency, especially since Norcross retains a 37 per cent stake and will be in a position to renew its attack this autumn. These figures reflect the success of an all-round overhaul, yielding better margins on a slightly higher turnover.

Against £2m loss in last year, but the unwelcome approach created a new sense of urgency, especially since Norcross retains a 37 per cent stake and will be in a position to renew its attack this autumn. These figures reflect the success of an all-round overhaul, yielding better margins on a slightly higher turnover.

Against £2m loss in last year, but the unwelcome approach created a new sense of urgency, especially since Norcross retains a 37 per cent stake and will be in a position to renew its attack this autumn. These figures reflect the success of an all-round overhaul, yielding better margins on a slightly higher turnover.

The Chairman reports:

Results for 1983
Despite worldwide economic adversities in 1983, the group once again increased its profits, to HK\$2,492 million, an increase of 5.7 per cent compared with 1982.

At the Ordinary Yearly General Meeting a final dividend of 37 cents will be recommended. As in previous years, a bonus issue will be recommended, this time on the basis of one new share for every four held.

Your Board expects to be able to pay at least the same quantum of dividend for 1984 as for 1983 - not less than HK\$0.44 per share as increased by the recommended bonus issue.

The Economic Situation
During 1983 we could see the global economy begin to emerge from its long and deep recession, but there has been an uneven pattern of recovery.

The Asia-Pacific region is going to be a prime testing ground for the ability of the banking system to cope with the problem of resource allocation. During 1983 the region as a whole demonstrated remarkable resilience in the face of difficulties shared with other major trading and producing areas.

Expansion of Hong Kong's economy accelerated in the second half of the year and into 1984 when exports showed record figures and order books were being rapidly filled. Action to stabilise the Hong Kong dollar, taken by the Government in the autumn of 1983, brought about a steadying of business confidence which has continued since.

Confidence has subsequently been boosted by progress in the discussions between the United Kingdom and The People's Republic of China on the constitutional future of Hong Kong. This sentiment rests on the general expectation that the final form of the agreement will embody assured recognition of Hong Kong's distinctive needs.

Greater overseas investment in Hong Kong during 1983 indicates how the territory's prospects are now perceived by its growing community of international investors, both individual and corporate. Your Bank shares this confidence and looks forward to promoting the economy of the territory, not only in its home base, but through our worldwide network.

New Headquarters
Work on our new headquarters building, in Queen's Road Central, has settled down to a smooth and rapid routine of construction, and we can now look forward to the first phase of occupation, in July 1985, starting with the banking hall.

Commercial Banking
Although we faced intensifying competition and difficult trading conditions in all our

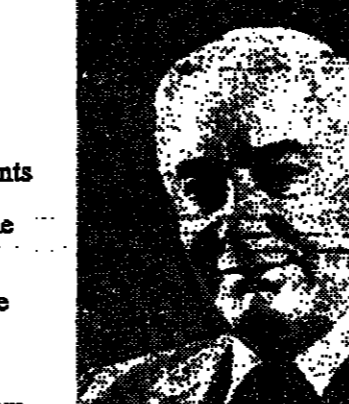

Mr M G R Sandberg, CBE, Chairman

main operating areas, the results nonetheless show that our operations remain strong. Fortunately by the standards of other leading banking groups around the world our exposure to the difficulties of sovereign debt is comparatively small.

The Hang Seng Bank has again produced good results and undertook a significant role in supporting industrial sectors in a difficult period. Our Area Office China was closely involved in the increasing commerce between Hong Kong and The People's Republic of China, and our close association with China over more than a century is an established asset.

Marine Midland Bank reported income growth of 16.2 per cent which brought profits in 1983 to just over US\$100 million; our partnership constitutes a source of real strength to both banks. The British Bank of the Middle East again reported increased results, despite the drop in Middle East oil revenues and region-wide political problems.

HongkongBank opened further branches in various centres, as far apart as Valparaiso and Leeds. The representative office in Taiwan has now been upgraded to full branch status.

In the first half of 1984 we plan to open a representative office in Stockholm, the first permanent presence for the group in Scandinavia.

Merchant Banking
Our merchant banking operations had a difficult year, affected both by adverse conditions in the world markets and by some local problems. These adversely affected the performance of Wardley Limited in Hong Kong in the first half of the year. However, developments in the second half of the year have struck a more positive note. Wardley Australia had a particularly good year. Wardley Middle East and Equator Bank Ltd continued to expand their operations and contacts in the markets of the Middle East and independent Africa respectively.

Finance and Investment
Greenville Transportation Holdings Ltd, which holds our transportation portfolio, produced very satisfactory results. Our hire-purchase and finance companies in Hong Kong, Brunei, Malaysia, Singapore and the Middle East all reported satisfactory results.

Insurance
The Carlingford and Gibbs Insurance Groups continued their expansion, both geographically and in services. The cross-marketing of group capabilities is gaining wider recognition for the group's insurance strength.

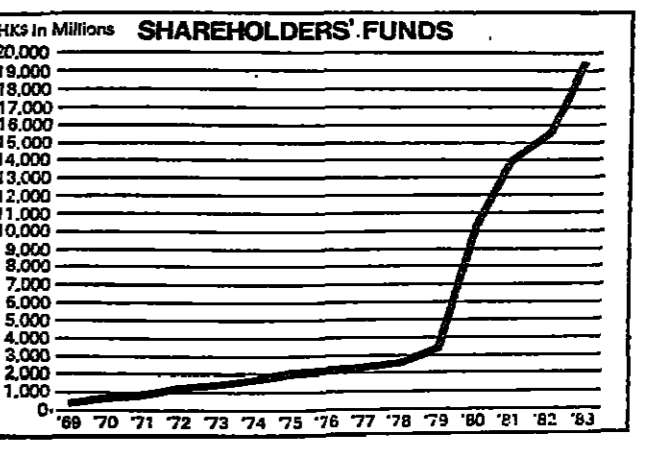
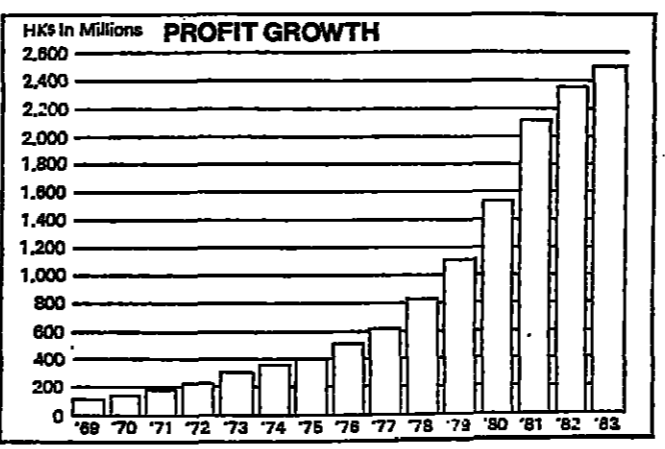
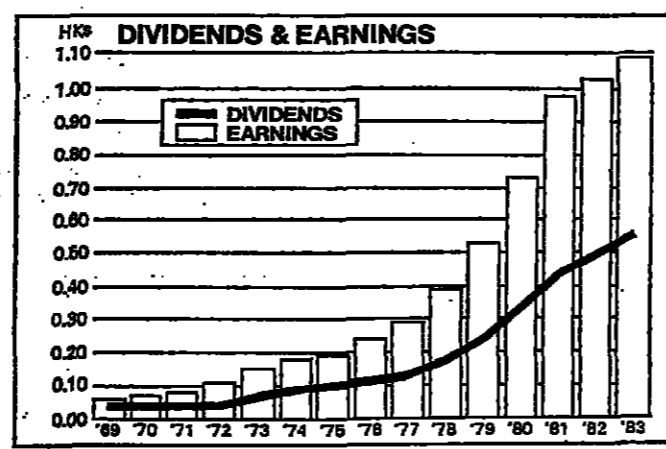

IHI

Ishikawajima-Harima Heavy Industries Co. Ltd.

U.S. \$50,000,000 Guaranteed Floating Rate Notes Due 1985

For the six months April 27th, 1984 to October 27th, 1984.

In accordance with the provisions of the Note, notice is hereby given that the rate of interest has been fixed at 11 7/8 per cent and that the interest payable on the relevant interest payment date, October 29th, 1984, against Coupon No. 13 will be U.S. \$58.78.

By: Morgan Guaranty Trust Company of New York, London Agent Bank

Main Results	1983		1982		1983	
	HK\$ millions		HK\$ millions		£ millions	
Total Assets	470,315		379,186		41,606	
Issued Capital	5,720		5,200		506	
Total Shareholders' Funds	19,586		15,606		1,733	
Group Profit	2,492		2,357		221	
Transfers to Reserves	504		440		45	
Total Distribution	1,258		1,144		111	
Earnings per share	1.09		1.03		0.10	
Dividend per share	0.55		0.50		0.05	



Hongkong Bank
The Hongkong and Shanghai Banking Corporation

Marine Midland Bank • Hongkong Bank of Canada
The British Bank of the Middle East
Hang Seng Bank Limited • Wardley Limited
Wardley London Limited

Fast decisions. Worldwide.

Main London Office:
P.O. Box 199, 99 Bishopsgate, London EC2P 2LA. Tel: 01-638 2366
Offices in Birmingham, Edinburgh, Leeds and Manchester



HOUSE OF FRASER plc

Profit increases by 25%

Summary of Results for the 52 weeks ended 28th January, 1984	1984 £'000	1983 £'000	% change
Total Turnover	955,962	876,726	+9%
Profit on Ordinary Activities before Taxation	38,763	30,882	+25%
Profit for the Financial Period (after Taxation and Extraordinary Items)	27,857	22,580	+23%
Dividends Paid and Proposed	13,040	11,453	+14%
Earnings per Ordinary Share	18.9p	14.3p	+32%
Dividend per Ordinary Share	8.5p	7.5p	+13%

This summary does not constitute the full accounts of the Group on which the Auditors have given an unqualified audit report. The full accounts have not yet been delivered to the Registrar of Companies.

Results

Profit on Ordinary Activities before Taxation increased 25% which is all the more encouraging in view of the affect of refurbishment and extensions on individual stores.

Development

Harrods' major development programme and the extension to the Army & Navy Maidstone Store were completed during the period. Refurbishment was carried out at D H Evans and Dickens & Jones in London as well as at our Stores in Manchester, Sunderland and Glasgow.

Two exciting new Stores have been built at Perth and Epsom and the redesign of the Birmingham, Edinburgh and Leamington Spa Stores has already begun.

Outlook

Current Turnover is ahead of this time last year and of internal budgets. Profitability at the half year should continue to show an improving trend.

Dividend

The Board is recommending a Final Dividend of 6.0p on the Ordinary Shares for the period ended 28th January, 1984. This Dividend, if approved, will be paid on 6th July, 1984 to shareholders on the register at the close of business on 18th May, 1984.

The total distribution for the period of 8.5p per share compares with 7.5p per share for the previous period.

Fine stores for quality, value and service

Notice of Mandatory Redemption

Norsk Hydro a.s

U.S.\$40,000,000 9 3/4 per cent Bonds 1985

Notice is hereby given, pursuant to the provisions of the Trust Deed dated May 15th, 1975 between Norsk Hydro a.s and The Law Debenture Corporation p.l.c. as Trustee, that \$5,000,000 nominal of the Notes is due for mandatory redemption on June 1st, 1984. Pursuant to Clause 4(C) of the Terms and Conditions of the Notes, U.S.\$3,428,000 principal amount has been purchased by the Company and credited against the amount due for redemption.

The serial numbers of the Notes drawn for redemption representing \$1,572,000 principal amount are as follows:-

25	3827	9447	13410	19038	16774	19219	20581	22273	25047	26234	26951	28877	29904	30673	31916	33185	34687	35681	36822	38746	
32	3928	9448	13423	19051	16800	19258	20620	22312	25086	26273	26990	28916	29943	30712	31955	33224	34726	35720	36861	38785	38787
37	3929	9449	13436	19064	16813	19271	20633	22325	25101	26288	26999	28925	29952	30721	31964	33233	34735	35729	36870	38794	38796
42	3930	9450	13449	19077	16826	19284	20646	22338	25114	26301	27002	28928	29955	30724	31967	33236	34738	35732	36873	38797	38799
47	3931	9451	13462	19090	16839	19297	20659	22351	25127	26314	27015	28940	29967	30737	31980	33249	34740	35734	36874	38798	38800
52	3932	9452	13475	19103	16852	19310	20672	22364	25140	26327	27028	28953	29980	30750	31993	33260	34741	35738	36875	38799	38801
57	3933	9453	13488	19116	16865	19323	20685	22381	25153	26340	27041	28966	29993	30763	32006	33271	34742	35741	36876	38800	38802
62	3934	9454	13501	19129	16878	19336	20698	22398	25166	26353	27054	28981	30006	30776	32019	33282	34743	35742	36877	38801	38803
67	3935	9455	13514	19142	16891	19349	20711	22415	25179	26366	27067	29006	30016	30786	32028	33293	34744	35743	36878	38802	38804
72	3936	9456	13527	19155	16904	19362	20724	22432	25192	26379	27078	29021	30026	30796	32039	33304	34745	35744	36879	38803	38805
77	3937	9457	13540	19168	16917	19375	20737	22449	25205	26392	27089	29036	30036	30806	32049	33315	34746	35745	36880	38804	38806
82	3938	9458	13553	19181	16930	19388	20750	22466	25218	26405	27100	29051	30046	30816	32059	33326	34747	35746	36881	38805	38807
87	3939	9459	13566	19194	16943	19401	20763	22483	25231	26418	27111	29066	30056	30826	32069	33332	34748	35747	36882	38806	38808
92	3940	9460	13579	19207	16956	19414	20776	22500	25244	26431	27122	29081	30066	30836	32079	33339	34749	35748	36883	38807	38809
97	3941	9461	13592	19220	16969	19427	20789	22517	25257	26444	27133	29096	30076	30846	32089	33346	34750	35749	36884	38808	38810
102	3942	9462	13605	19233	16982	19440	20802	22534	25270	26457	27144	29111	30086	30856	32099	33352	34751	35750	36885	38809	38811
107	3943	9463	13618	19246	16995	19453	20815	22551	25283	26470	27155	29126	30096	30866	32109	33359	34752	35751	36886	38810	38812
112	3944	9464	13631	19259	17008	19466	20828	22568	25296	26483	27166	29141	30106	30876	32119	33366	34753	35752	36887	38811	38813
117	3945	9465	13644	19272	17021	19479	20841	22585	25309	26496	27177	29156	30116	30886	32129	33373	34754	35753	36888	38812	38814
122	3946	9466	13657	19285	17034	19492	20854	22602	25322	26509	27188	29171	30126	30896	32139	33380	34755	35754	36889	38813	38815
127	3947	9467	13670	19298	17047	19505	20867	22619	25335	26522	27199	29186	30136	30906	32149	33387	34756	35755	36890	38814	38816
132	3948	9468	13683	19311	17060	19518	20880	22636	25348	26535	27210	29201	30146	30916	32159	33394	34757	35756	36891	38815	38817
137	3949	9469	13696	19324	17073	19531	20893	22653	25361	26548	27221	29216	30156	30926	32169	33401	34758	35757	36892	38816	38818
142	3950	9470	13709	19337	17086	19544	20906	22670	25374	26561	27232	29231	30166	30936	32179	33408	34759	35758	36893	38817	38819
147	3951	9471	13722	19350	17099	19557	20919	22687	25387	26574	27243	29246	30176	30946	32189	33415	34760	35759	36894	38818	38820
152	3952	9472	13735	19363	17112	19570	20932	22704	25400	26587	27254	29261	30186	30956	32199	33422	34761	35760	36895	38819	38821
157	3953	9473	13748	19376	17125	19583	20945	22721	25413	26600	27265	29276	30196	30966	32209	33429	34762	35761	36896	38820	38822
162	3954	9474	13761	19389	17138	19596	20958	22738	25426	26613	27276	29291	30206	30976	32219	33436	34763	35762	36897	38821	38823
167	3955	9475	13774	19402	17151	19609	20971	22755	25439	26626	27287	29306	30216	30986	32229	33443	34764	35763	36898	38822	38824
172	3956	9476	13787	19415	17164	19622	20984	22772	25452	26639	27298	29321	30226	30996	32239	33450	34765	35764	36899	38823	38825
177	3957	9477	13800	19428	17177	19635	21000	22789	25465	26652	27309	29336	30236	31006	32249	33457	34766	35765	36900	38824	38826
182	3958	9478	13813	19441	17190	19648	21013	22806	25478	26665	27320	29351	30246	31016	32259	33464	34767	35766	36901	38825	38827
187	3959	9479	13826	19454	17203	19661	21026	22823	25491	26678	27331	29366	30256	31026	32269	33471	34768	35767	36902	38826	38828
192	3960	9480	13839	19467	17216	19674	21039	22840	25504	26691	27342	29381	30266	31036	32279	33478	34769	35768	36903	38827	38829
197	3961	9481	13852	19480	17229	19687	21052	22857	25517	26704	27353	29396	30276	31046	32289	33485	34770	35769	36904	38828	38830
202	3962	9482	13865	19493	17242	19700	21065	22874	25530	26717	27364	29411	30286	31056	32299	33492	34771	35770	36905	38829	38831
207	3963	9483	13878	19506	17255	19713	21078	22891	25543	26730	27375	29426	30296	31066	32309	33499	34772	35771	36906	38830	38832
212	3964	9484	13891	19519	17268	19726	21091	22908	25556	26743	27386	29441	30306	31076	32319	33506	34773	35772	36907	38831	38833
217	3965	9485	13904	19532	17281	19739	21104	22925	25569	26756	27397	29456	30316	31086	32329	33513	34774	35773	36908	38832	38834
222	3966	9486	13917	19545	17294	19752	21117	22942	25582	26769	27408	29471	30326	31096	32339	33520	34775	35774	36909	38833	38835
227	3967	9487	13930	19558	17307	19765	21130	22959	25595	26782	27419	29486	30336	31106	32349	33527	34776	35775	36910	38834	38836
232	3968	9488	13943	19571	17320	19778	21143	22976	25608	26795	27430	29501	30346	31116	32359	33534	34777	35776	36911	38835	38837
237	3969	9489	13956	19584	17333	19791	21156	22993	25621	26808	27441	29516	30356	31126	32369	33541	34778	35777	36912	38836	38838
242	3970	9490	13969	19597	17346	19804	21169	23010	25634	26821	27452	29531	30366	31136	32379	33548	34779	35778	36913	38837	38839
247	3971	9491	13982	19610	17359	19817	21182	23027	25647	26834	27463	29546	30376	31146	32389	33555	34780	35779	36914	38838	38840
252	3972	9492	13995	19623	17372	19830	21195	23044	25660	26847	27474	29561	30386	31156	32399	33562	34781	35780	36915	38839	38841
257	3973	9493	14008	19636	17385	19843	21208	23061	25673	26860	27485	29576	30396	31166	32409	33569	34782	35781	36916	38840	38842
262	3974	9494	14021	19649	17398	19856	21221	23078	25686	26873	27496	29591	30406	31176	32419	33576	34783	35782	36917	38841	38843
267	3975	9495	14034	19662	17411	19869															

RTZ '83

Broadly based, strongly placed

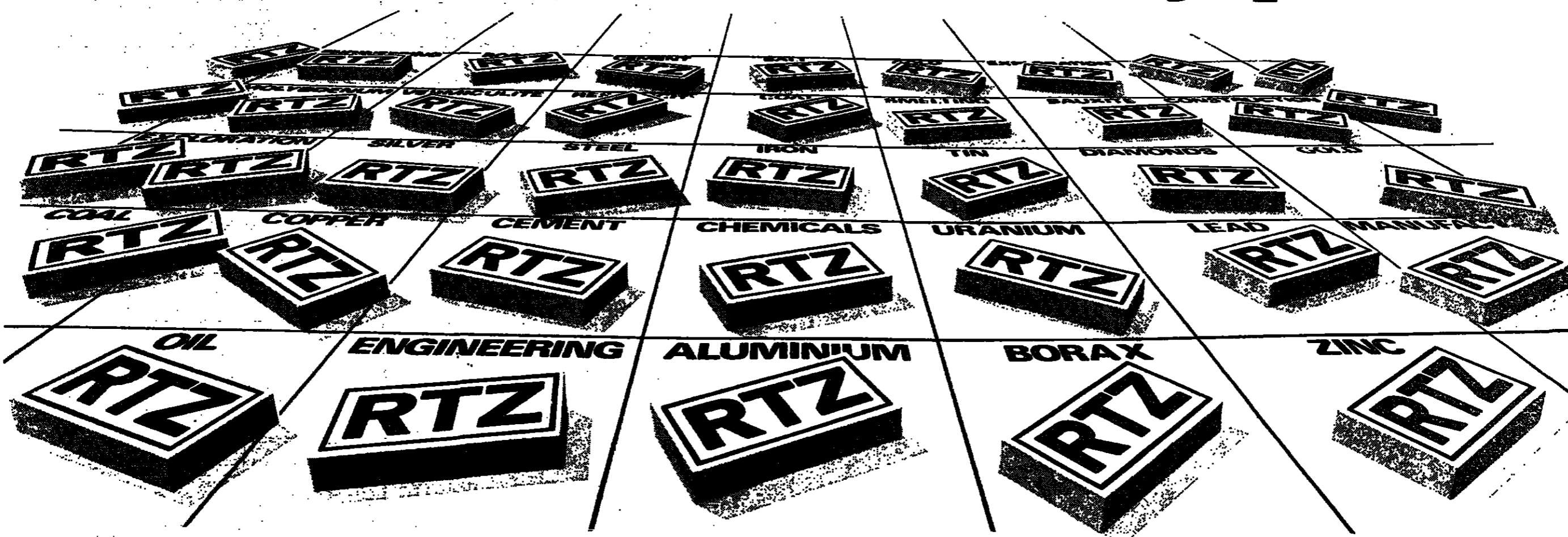

RTZ activities originally concentrated almost exclusively on mining and more recently have been broadened and diversified. Many of the Group's low-cost mines have by-products which contribute substantially to their overall profitability. Group companies now operate throughout the world in a wide spread of industries related to natural resources. These include metal processing and fabrication, engineering, the production and sale of chemicals and of construction materials and developing energy interests. Because of diversification and persistently weak base metal markets, the relative importance of RTZ's industrial interests in recent years has grown in relation to mining.

Results

Our results this year show a satisfactory increase over 1981 and 1982, two of the most difficult years the mining industry has had to face since before the war.

RTZ's profitability depends significantly on metal prices. In some cases prices were even lower in 1983 than in 1982, and so the improvement in our results is all the more welcome. It stems partly from our broad geographical and industrial spread, and partly from the rigorous attention to costs throughout the Group.

Group companies now produce significant percentages of the Western World's bauxite, copper, iron ore, lead, tin, uranium and zinc, and lesser quantities, mainly as by-products, of gold, molybdenum and silver. Our mines are, for the most part, low-cost producers and can therefore show reasonable profits even when other mines are working at a loss. This is especially true in the case of copper, with Palabora to the fore as one of the most efficient and low-cost producers in the world.

These mining activities are supplemented by a broadening industrial base, mainly in the UK and North America, in cement and other construction materials, in metal fabricating and light engineering and in borax and its derivatives. Our interests in oil and gas are also expanding, and we hope to see further growth in this area during the next few years.

Outlook

What of 1984? Forecasts of metal prices are notoriously difficult, but, provided the economies of the OECD countries continue on their present course, the increased level of activity will benefit most parts of the Group and, considering the difficult conditions still being faced by the mining industry, the current year should be satisfactory. It would, however, be prudent to sound a note of caution because of uncertainties about the year's exchange rates. The impact of exchange rate movements on our business is highly complex as the many currencies involved often move in different directions and sometimes metal prices move in the opposite direction to exchange rates. If the US dollar continues to weaken, our reported profits could be adversely affected.

Metal prices

Last year we said that it would be some time before economic recovery came through to raw material producers. That was a sound prediction. International prices of lead and many minor minerals were lower in 1983, a year of recovery, than in 1982, and in many more instances, including copper, weakened markedly in the latter part of the year.

Those metals that did best, such as aluminium and to a lesser extent zinc, are more orientated towards the broadly based consumer spending that has so far fuelled the recovery, particularly in North America. They benefited also from heavy Eastern purchases, from continued substitution in their favour, and from the earlier sharp cutbacks of output by producers in the face of rising stocks.

The laggards are sold mainly to the intermediate and capital goods industries which have been scarcely touched by recovery; major markets in Europe and Japan have remained weak; and supply did not react sufficiently to falling demand.

In many metals, and again this includes copper, there is chronic over capacity that appears likely to persist for some years. We should, however, not underestimate the ability of the metal markets to spring surprises and confound established wisdom.

Protectionism

Our wide geographical spread means that we have a keen interest in the maintenance of an effective liberal international trading system. In this respect we have noted with growing concern the spreading tentacles of protection which are gradually choking trade in metals. The calls for protectionist measures against imports, often regardless of their relative costs, are understandable in conditions of rampant over-capacity and weak markets. Protection in any form is, however, merely a short term palliative rather than a fundamental cure to underlying economic problems.

Experience shows that temporary protectionist measures seldom, if ever, achieve their desired effects, whatever their sponsors originally claim, and as often as not turn out to be permanent.

Anthony Tuck
Chairman
6 St. James's Square, London SW1Y 4LD

Highlights from the Accounts

	1983	1982
Group sales revenue	£4,811.0m	£3,680.4m
Operating profit	623.5m	403.3m
Profit before tax	575.2m	341.0m
Profit after tax	296.3m	173.1m
Net attributable profit	172.5m	103.5m
Earnings per ord. share	59.31p	*38.44p
Dividends per ord. share		
Interim—paid	6.0p	5.5p
Final—proposed	12.0p	10.5p

* Adjusted for rights issue

Geographical source of profit by %

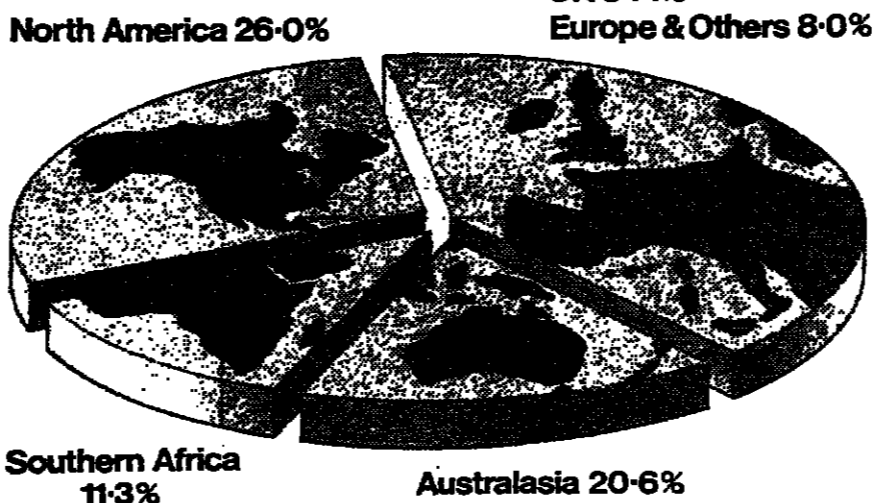

The Rio Tinto-Zinc Corporation PLC

If you would like a copy of the RTZ annual report including Sir Anthony's full statement please write to: Central Registration Limited, 1 Redcliff Street, Bristol BS1 6NT

New Issue
April 27, 1984

This advertisement appears
as a matter of record only

KINGDOM OF SWEDEN

DM 250,000,000

7 7/8% Deutsche Mark Bonds of 1984/1994



Offering price: 100%
Interest: 7 7/8% payable annually on May 3
Repayment: May 3, 1994 at par
Listing: Frankfurt am Main, Hamburg

Deutsche Bank Aktiengesellschaft	Dresdner Bank Aktiengesellschaft
Post- och Kreditbanken PKBanken	Skandinaviska Enskilda Banken
Svenska Handelsbanken	
Commerzbank Aktiengesellschaft	Swiss Bank Corporation International Limited
	Westdeutsche Landesbank Girozentrale
Abu Dhabi Investment Company	Alahli Bank of Kuwait (K.S.C.)
Amro International Limited	Arab Banking Corporation Dus & Co. GmbH
Atlantic Capital Corporation	Baden-Württembergische Bank Aktiengesellschaft
Banca Commerciale Italiana	Banca del Gottardo
Bank of America International Limited	Bank für Gemeinwirtschaft Aktiengesellschaft
Bank of Tokyo International Limited	Bank J. Vontobel & Co. AG
Banque Française du Commerce Extérieur	Banque Générale du Luxembourg S.A.
Banque Internationale à Luxembourg S.A.	Banque Nationale de Paris
Banque Paribas	Banque Populaire Suisse S.A. Luxembourg
Baring Brothers & Co., Limited	H. Albert de Bary & Co. N.V.
Bayerische Landesbank Girozentrale	Bayerische Vereinsbank Aktiengesellschaft
Berliner Bank Aktiengesellschaft	Berliner Bank Aktiengesellschaft
Blyth Eastman Paine Webber International Limited	CIBC Limited
Chemical Bank International Limited	Copenhagen Handelsbank
Compagnie de Banque et d'Investissements, CBI	Crédit Lyonnais
Crédit Industriel et Commercial	
Creditanstalt-Bankverein	Daewa Europe Limited
Den Danske Bank af 1871 Aktieselskab	Den norske Creditbank
Deutsch-Scandinavisches Bank (Luxembourg) SA	DG Bank
Euromobiliare S.p.A.	Deutsches Genossenschaftsbank European Banking Company Limited
Goldman Sachs International Corp.	Gästabanken
Hambros Bank Limited	Hamburgische Landesbank - Girozentrale -
Hill Samuel & Co. Limited	Industriebank von Japan (Deutschland) Aktiengesellschaft
Kansallis-Osake-Pankki	Kidder, Peabody International Limited
Kredietbank N.V.	Kredietbank S.A. Luxembourggoise
Landesbank Rheinland-Pfalz - Girozentrale -	Landesbank Schleswig-Holstein Girozentrale
Lehman Brothers Kuhn Loeb International, Inc.	Lloyds Bank International Limited
Manufacturers Hanover Limited	McLeod Young Weir International Limited
Merrill Lynch International & Co. Limited	B. Metzler seel. Sohn & Co.
Morgan Grenfell & Co. Limited	Morgan Guaranty Ltd
New Japan Securities Europe Limited	The Nikko Securities Co., (Europe) Ltd.
Norddeutsche Landesbank Girozentrale	Nordic Bank Limited
Orion Royal Bank Limited	Postipankki
Salomon Brothers International Limited	Scandinavian Bank Limited
Smith Barney, Harris Upham & Co. Incorporated	Société Générale
Sundsvallsbanken	Swedbank
Union Bank of Finland Ltd.	Union Bank of Switzerland (Securities) Limited
M.M. Warburg-Brinckmann, Wirtz & Co.	S. G. Warburg & Co. Ltd.
	Yamaichi International (Europe) Limited

Midland Industries share price slumps 56% to 7p

BY ALEXANDER NICOLL

THE SHARE price of Midland Industries, a Wolverhampton-based engineering and foundry group, lost over half of its value yesterday. This followed the sale by Swiss-based businessman Mr Edward Nassar of part of his recently acquired stake in the company.

Mr Nassar disclosed earlier this month that he had taken a 7 1/4 per cent stake in Midland and in response the share price rose 9p to 24p on April 11. But earlier this week Mr Nassar told the company that he had sold 300,000 shares, or 2.3 per cent, and yesterday the price fell 9p to 7p, a fall of 56 per cent.

At yesterday's closing price, which compares with a 1983 high

of 50p, the company has a stock market valuation of £903,000. Midland has yet to report full year results for 1983 but said in October that it was then trading profitably after recording a first half loss of £1.83m, compared with a pre-tax profit of £205,000 in the comparable period of the company.

In the whole of 1983 Midland had pre-tax profits of £261,000 on turnover of £24.7m.

No directors of Midland were available at the company's headquarters yesterday, and the company made no comment on the share price fall. Company officials said that the chief executive, Mr Peter Burton, and the company secretary, Brian Meddings, were in London for routine talks with Midland's

bankers.

The officials said Midland's brokers had informed the company of stock market rumours that it was discussing the appointment of a receiver, and stressed that the rumours were without foundation. Midland hopes to publish its 1983 figures in the near future, they said.

Mr Eddie Marsland, the company's chairman, owns 32 per cent of Midland. The company has spent heavily on developing new techniques and products when faced with a decline in the markets for its traditional foundry products.

Midland paid a total dividend of 2.6p per share in 1982 but passed its interim payment last year.

Samuel Properties at £1.6m

While turnover of Samuel Properties fell from £3.98m to £3.87m following a lower level of trading activity, pre-tax profits for the six months to December 31 1983 were virtually unchanged at £1.04m, against £1.05m last time.

The directors anticipate a satisfactory outcome for the year as a whole, although taxable profits are unlikely to include a £200,000 exceptional credit in connection with the surrender of a lease by an occupying tenant.

Tax for the half year was lower at £353,000 (£400,000) and net profit per share rose from 3.8p to 3.51p. The net interim dividend is raised to 1.5p (1.45p)—last year's final was 3.77p.

Net property investment income was 14 per cent higher than for the previous corresponding period.

Comet reveals profits setback

Comet has revealed the extent of its profits setback in the first half year. The company's Woolworth Holdings which is making an agreed £177m bid for the Hull-based electrical retailer.

When Comet's chairman Mr Michael Hollingsbery reported record profits of £19.5m for the year to August 27 1983 he struck a cautious tone in his statement regarding future trading. The offer document from Woolworth reveals that Comet's profits in the half year to March 3 1984 were no more than about £12m, compared with £12.76m for the corresponding period. This was despite an increase in turnover estimated at £213m against £194m.

While the group's turnover

increased by 9 per cent Mr Hollingsbery points out that trading margins came under pressure.

After the disappointing interim outcome, the directors say that it is too early to forecast for the full year. However, the statement goes on to say: "As far as current trading is concerned, national industrial unrest always has a negative effect on consumer confidence resulting in a reduction in the level of retail sales. This is affecting Comet."

The performance is in stark contrast to most stockbrokers' estimates. Virtually all the analysts had been anticipating Comet to increase its profits this year to over £20m.

The statement goes on to tell

shareholders that if Woolworth's offer goes unconditional, the directors intend to declare an increased interim dividend of 1p per share.

Mr Hollingsbery says that as part of Woolworth, Comet would operate as an independent division under its existing management.

While current trading conditions are difficult, he believes that with the underlying trend of discretionary income remaining strongly upwards, improved consumer spending will occur once confidence returns.

"The combined resources of Holdings (Woolworth) and Comet should put us into a stronger position to take advantage of this and to continue our expansion plans."

Pentos proposal

Pentos is proposing that the share premium account be reduced by the amount of the deficit at December 31 1983 on the group's profit and loss account.

Mr T. A. Maher, the chairman, says the company will wish to consider the resumption of dividend payments as profitability and cash generation continue to improve. He indicates that the purpose of the proposals is "to facilitate the payment of dividends out of future profits by the elimination of the deficit on distributable reserves."

For the proposals to be implemented the approval of shareholders, convertible loan stockholders and the court is required. Holders of the whole of the original loan stock, comprising £1m out of the total loan stock outstanding of £1.64m, have already sanctioned the proposals.

The interest rate on the loan stocks is to be increased from 13 per cent to 13.5 per cent per annum from and including August 1 1984, conditional upon the proposals becoming effective which is anticipated to take place next September.

BIDS AND DEALS IN BRIEF

English Association Group, merchant banking services concern, has subscribed through its wholly owned subsidiary, The English Association for Investment Trust Company, for a substantial minority interest in Ebersley Hicks (Underwriting Agencies).

This is English Association's first venture into the Lloyds market and the directors consider the investment a natural extension to their business.

Ebersley Hicks acts for approximately 100 underwriting members of Lloyds and the involvement with English Association will enable it to take advantage of any suitable opportunities for expansion as a result of the Lloyds Act.

Mr Christopher Spence, a director of English Association, has joined the board of Ebersley Hicks.

In Scotland, this forms part of a £15m funding package.

An initial tranche of £4.5m equity is being provided by a group consisting of Investors in Industry, Newmarket (Venture Capital), Scottish Development Agency, Charterhouse Japhet, AFA Venture Capital Fund, and Industrial Investments (owned by NCB Pension Funds). In addition the new company will qualify for £4.2m of Government grants.

The City merger wave has cleared the monopolies hurdle. The Department of Trade and Industry has decided not to refer four recent mergers between banks and stock exchange members to the Monopolies and Mergers Commission.

The deals are: Barclays Bank's 29.9 per cent stake in Weddicher-Mardant's jobbing firm and its 49.9 per cent stake in de Zoete and Svan, the stockbrokers; NatWest's 29.9 per cent stake in Bigwood Bishop, the tobacconists; and Samuel Montagu's 29.9 per cent stake in Green wells, the stockbrokers.

Total acceptances therefore amount to 137,881,042 shares (99.46 per cent).

Elections for loan stock received during the period from 3.30 pm on April 11 until 3.30 pm on April 25 amounted to £210,025, which falls within the limit of £207,225 loan stock available for the current period for allocation to accepting shareholders of Eagle Star.

Accordingly, elections to receive loan stock received during the current period and valid in all respects will be satisfied in full. Elections to receive capital notes which are valid will also be satisfied in full.

Acceptances of the unconditional offers from Hawker Siddeley Group, representing 99.3 per cent and 47.4 per cent respectively of the ordinary and preference shares.

Prior to the offers Hawker held 72.4 per cent of the Carlton ordinary with the acceptances amount in aggregate to 99.8 per cent. The offers have been extended until 3 pm on May 17.

Mr Ian S. Salmon and associates have acquired from Fenragon Inc. of Liberia a total of 1.15m ordinary shares in Tamin Securities representing 29.9 per cent of its issued share capital. A further 2,975,418 shares in Tamin, being the balance of Fenragon's holding, have been acquired by non-discretionary clients of stockbrokers, Rensburg and Co. in Liverpool and Springer Bale and Lewis in London.

Tamin (formerly Elitija Rubber Holdings) is an unlisted public investment holding and dealing company.

United Trust and Credit, a financial services group, has acquired investment holding company, Avonlaw for £304,500 by the issue of 145,000 ordinary £1 shares at £2.10 each. Avonlaw has assets of approximately £300,000 in cash and short dated gilts, and its acquisition which is conditional on certain tax clearances will further strengthen the UTC's capital base for future expansion.

The directors of UTC have increased the authorised share capital in the company by £1m to £2.5m.

At 3.30 pm on April 25, further acceptances of B.A.T. Industries' offer for Eagle Star had been received in respect of 97,557 Eagle Star shares (0.07 per cent).

British Syndicate, a member of the Robert Fleming Group, has acquired a 50 per cent stake in concert with Sutcliffe, which has acquired a further 50,000 French ordinary shares at a price of 127p.

Francis Inns—P. M. Tapscott, a director, purchased 15,000 ordinary shares increasing total interest to 48,500 shares. D. M. Saunders, a director, has bought by Emroy Finance £531 shares altering total holding to 145,631 shares including those under option to him.

Sunbeam Wolsey—K. A. Mulcahy, a director, sold 80,000 ordinary shares.

Associated British Engineering—M. J. Barry, a director, has disposed of 200,000 ordinary shares, reducing beneficial holding to 200,478 shares.

United Finance Holdings—M. J. Rosenbaum, a director, has disposed of £14,945 ordinary Atok units reducing holding to £23,250 units (15.74 per cent).

BANK RETURN

	Wednesday April 25 1984	Increase (+) or Decrease (-) for week
BANKING DEPARTMENT		
Liabilities	£	£
Capital	14,555,000	
Public Deposits	45,119,119	+ 4,329,539
Bankers Deposits	589,537,630	+ 71,447,469
Reserve and other Accounts	1,465,275,538	+ 25,432,069
	2,098,535,086	+ 45,691,644
Assets		
Government Securities	394,445,419	- 91,415,000
Advances & other Accounts	577,465,288	- 101,880,067
Premises Equipment & other Secs.	1,399,216	+ 144,044,565
Notes	5,399,216	+ 565,150
Coin	156,843	+ 15,800
	2,098,535,086	+ 45,691,644

ISSUE DEPARTMENT

	£	£
Liabilities		
Notes issued	11,980,000,000	+ 30,000,000
In circulation	11,974,800,294	+ 30,424,840
In Banking Department	5,559,516	+ 666,160
Assets		
Government Debt	11,015,100	
Other Government Securities	3,176,187,715	+ 805,306,769
Other Securities	2,785,787,187	+ 175,306,769
	11,980,000,000	+ 30,000,000

Holborn Fund Management (Guernsey) Ltd., P.O. Box 61, Bermuda House, St. Julian's Ave., St. Peter Port, Guernsey. 0481-26268.

Holborn Currency Fund Limited

Prices as at 26.4.84

	Bid	Offer	DM Dep.	DM 50.48	DM 50.67
Mex. \$	99.7p	100.0p	Sw Fr Dep.	Sw Fr 198	Sw Fr 50
Mex. US \$	89.83	89.86	J. Yen Dep.	Yen 5,055	Yen 5,075
£ Dep.	101.5p	102.3p			
US \$ Dep.	\$ Nil	\$ 10			

ROTHSCHILD ASSET MANAGEMENT (CI)
St Julian's Court, St Peter Port, Guernsey 0481 26741
O.C. INTERNATIONAL RESERVES LIMITED

	AS	15.089	+ 004	Yield
Australian Dollars	DKR	150.859	+ 038	8.84
Hong Kong Dollars	HKS	100.371	+ 018	6.23
Danish Kroner				
				Daily Dealings

Laporte — Record growth continues

PRELIMINARY ANNOUNCEMENT OF THE RESULTS FOR THE 52 WEEKS ENDED 1st JANUARY 1984.

- * Record profit in 1983 — up 50%
- * Dividend increased to 10.5p per share — up 20%
- * Scrip issue — 1 for 2
- * Good year for all the Intercox companies
- * Sound progress in all product areas
- * New acquisitions perform superbly
- * Very encouraging start to 1984

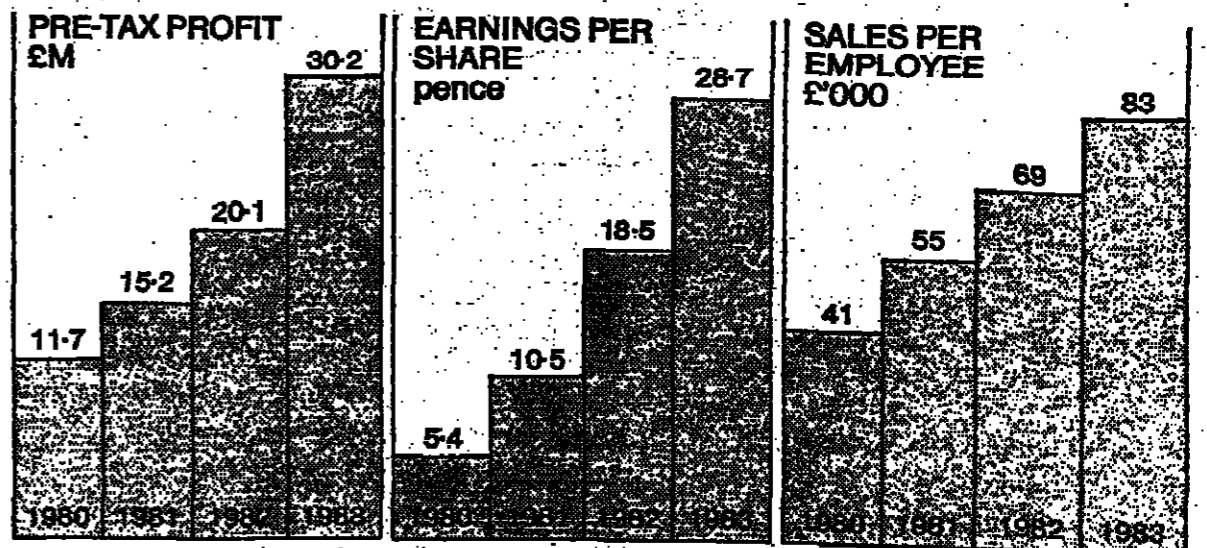

LAPORTE SPECIALIST CHEMICALS AND RELATED SERVICES — WORLDWIDE
Laporte Industries (Holdings) PLC, Hanover House, 14 Hanover Square, London W1R 0BE.

UK COMPANY NEWS

Wordplex full listing via offer for sale by tender

BY ALISON HOGAN

WORDPLEX, which sells and provides support for a range of electronic equipment and software for office automation, is coming to the market for a full listing.

It is making an offer for sale by tender of most of its issued share capital of a minimum price of 240p per share, capitalising it at £24.4m.

Wordplex is a wholly owned subsidiary of Canada Development Corporation, an investment holding company in which the Canadian Government has a significant stake and which decided that Wordplex, as a UK based group with minimal presence in Canada, was no longer an appropriate investment.

The issue will raise approximately £10m of new funds for Wordplex which will strengthen its balance sheet. CDC subscribed for shares worth £9.5m in Wordplex while the new chairman Mr John Heywood subscribed for £500,000 of shares for cash through his investment company Towergold, which will

have around 2 per cent of the issued share capital with an option over a further 1.6 per cent.

Wordplex has carved out a niche from its main competitors Wang and IBM by concentrating on winning large orders from fewer clients aiming for major businesses and governmental organisations.

Wordplex went through a costly demerger from AES which is another computer subsidiary of CDC, in 1980-81. The costs in buying back marketing rights and re-establishing independent distribution networks resulted in a pre-tax loss of £1.52m and £61,000 in 1981 and 1982 respectively. Turnover, however, increased from £17.2m in 1981 to £31.9m in 1983 when Wordplex made profits of £1.33m. It forecasts profits of not less than £800,000 for the first half of the current year to June 1984.

The yield on the forecast dividend is 1 per cent.

Wordplex should be admitted to the Stock Exchange by May 2,

the closing date for applications, and dealings are expected to commence on May 10.

Comment

Wordplex comes to the market with an offer of an unusually high proportion of its issued capital, all but a 2 per cent stake taken by Towergold. Hill Samuel have decided that with no direct comparison on the UK Stock Exchange and only giants such as IBM and Wang as its main competitors to look to in the U.S., a tender method is the best way to sell the shares. The company has come to the market early after extracting itself from the disastrous AES merger.

The company would be easier to assess another year or so on, but CDC could not wait that long to divest. A p/e of under 11 is not demanding for the office equipment sector which averages around 16. A fair institutional interest is expected so small investors hoping to get some shares should watch the price comfortably above the minimum of 240p.

BSR ready for growth following shake-out

IN THE first quarter of the current financial year, Mr Bill Wylie told shareholders of BSR International at yesterday's AGM of the Hong Kong-based electronics group, management has introduced "dramatic changes" in its Blauvelt, New York, distribution subsidiary.

It has also decided to close the parallel operation in Canada, moved out of the Philippines free trade zone and is now poised to sign a joint venture agreement in Singapore with a breakaway of executives from National Semi-Conductor.

As to current trading, Mr Wylie said, "On balance we are about where we expected to be at this time of the year and there is no alteration to our earlier 1984 forecast of strong growth, predominantly in the second half."

The first half was proving one of consolidation after the major reorganisation called for 40 subsidiaries around the world were identified for closure, sale and liquidation, although BSR was still "cleaning up the skeletons which occasionally fall out of the cupboard."

Staff in the Blauvelt company has been trimmed from 170 to 70 people, and BSR now looks for "substantially greater profits" from its new policy of distributing only BSR products in the U.S., the group's most important market.

The Singapore semi-conductor business, which suffered badly last year from the collapse of the home video-games market, is on budget to make profits from July onwards. It now makes magnetic components for all the group's needs. Heads of agreement have been prepared with the Hong Kong-based team which will take a 50 per cent stake in BSR's Singapore operation to develop the new silicon packages required by the electronics industry.

Mr Wylie added, "we are not at all concerned about the likely impact of sovereignty transfer to China."

Turnover reaches £1,500 m workload at a record level.

George Wimpey PLC Preliminary Statement of Consolidated Financial Results (unaudited) for the year ended 31 December 1983.

	1983 £m	1982 £m
Turnover:		
Work carried out by the Group	1393.0	1128.0
Attributable share of Associates work	87.0	112.0
	1480.0	1240.0
Operating Profit of the Group	55.8	55.7
Exceptional items		
profits	42.1	
losses	(41.7)	
Share of profits less losses of Associates	(0.1)	0.8
	56.1	56.5
Interest — net payable	(11.1)	(10.8)
Profit before Taxation	45.0	45.7
Taxation	(7.0)	(7.4)
Profit after Taxation	38.0	38.3
Minority interests	0.9	(0.3)
Profit after Taxation and Minorities	37.1	38.6
Extraordinary item — Deferred Tax	(11.2)	
Profit attributable to Ordinary Shareholders	25.9	38.6
Dividends	8.6	7.7
Retained Profit for the Year	17.3	30.9

DIVIDENDS

The directors recommend a final dividend of 2.20p per share (1.86p) totalling £5,195,200 (£5,504,000) which, if approved, will be paid on 2 July, 1984 to all shareholders on the register at 1 June, 1984. This dividend, together with the interim dividend of 0.85p per share declared in September 1983 brings the total dividend in respect of 1983 to 3.05p per share (2.73p) totalling £5,588,500 (£7,850,000).

*Restated to reflect a 1 for 10 capitalisation issue of shares in 1983.

EXCEPTIONAL ITEMS

In February 1984, shareholders were informed of profits arising from a major programme of partly-owned property investment disposals and the inclusion of exceptional losses in the accounts for 1983.

The accounts for 1983 include exceptional profits of £42.1 million realised on the disposal of the Group's interests in Euston Centre Properties PLC and eight other property companies. As a result of these disposals revaluation reserves of £41.8 million have been realised.

The exceptional losses arise from three unrelated situations.

- (a) Losses incurred on a contract to construct a gas-electric scheme in Swaziland amount to £9.6 million. Both the ground conditions and eventual design were markedly different from those in the tender documents and substantial claims have been lodged. These are being vigorously pursued but are not anticipated in the accounts.
- (b) A joint-venture high-rise residential property development in central Hong Kong has ceased due to the considerable reduction in property

values there. The Group has honoured its financial obligations and written off its original investment, resulting in a loss of £9.2 million. The Group has renegotiated its position so that, depending on the extent to which property values in Hong Kong recover, it may recoup some of the loss.

(c) The Group has a 49% interest in an electrical and mechanical engineering company in Saudi Arabia which is in financial difficulty and is being supported by its shareholders. Losses of £16.4 million have been incurred on contracts and a further £5.5 million on overheads and the costs of reducing the company's activities. The directors believe that the losses have now been contained and adequate provisions made. The outcome will remain uncertain until contracts are completed and contractual claims settled.

POST BALANCE SHEET EVENT

In January 1984, the Group disposed of half its investment in The Oldham Estate Company PLC for £17 million and has granted the purchaser an option to acquire the balance of its holding for a consideration of £17.8 million, in aggregate £34.8 million. The book value of the entire holding in the 1983 accounts was £32.5 million compared with the original cost of £23,000. As a result, a profit of £17 million will be realised in 1984 and, if the option is exercised, £17.8 million in 1985.

Deferred taxation on the 1984 Oldham profit has been deducted from the investment revaluation reserve.

The Chairman and Chief Executive, Mr Cliff Chetwood, comments:

"I am pleased to report that, despite many difficulties and the continuing low economic activity in the UK, the Group has maintained its operating profit at £55.8 million compared with £55.7 million in the previous year. This is a good result in the circumstances. The Group's financial position remains strong.

The Wimpey Group is one of the world's leading construction organisations. We are currently carrying out more than 1,000 contracts worldwide, ranging from small site investigation and surfacing jobs to complex multi-million pound building, civil, mechanical, electrical, process and offshore engineering projects. In addition, we are one of the top ten property developers in the UK, with a substantial portfolio.

Housing

In the UK, I am heartened by our improved private housing performance. In the past two years new attractive house designs have been introduced to very high quality and safety standards. Investment in land has been directed at more but smaller estates and imaginative marketing measures introduced. Results started to improve in 1982. The upward trend has continued during 1983 when 9,330 house sales were legally completed, over 2,000 more than in 1981.

Wimpey's well established reputation for quality was reinforced with the award, yet again, of more National House Building Council "Pride in the Job" awards for quality of construction than any other builder. One NHBC report described us as "the builder by whose standard others are judged".

The Group policy has always been to give purchasers the best possible value for money, and the home-buying package has been progressively modified in the light of market research. Purchasers have the option to dispense with the whole or part of the package for a corresponding discounted price, although no less than 95% of them choose the package deal as against the basic house. First time buyers, moreover, are relieved of legal fees, stamp duty and the mortgage survey fee.

Energy and Process Engineering

We have restructured to offer a total capability in the sectors of energy and process engineering. Wimpey Engineering is now concentrating on the onshore process plant industry, while Wimpey Offshore Engineers and Constructors has been established to offer comprehensive engineering services to the international offshore oil and gas industries. Wimpey, our navigation services company, has just had its success in expanding its overseas business recognised by The Queen's Award for Export Achievement. I believe all these companies, operating in high technology areas, will successfully build on our past achievements in these activities.

Overseas

Although competition for contracting work overseas continues to be intense, we have secured important new contracts including a £147-million hospital in Oman. In Hong Kong, good progress is being achieved on the management contract for the headquarters of The Hongkong and Shanghai Banking Corporation. We have the capability successfully to pursue contracts such as these, and will continue to do so with vigour.

United States

I am particularly pleased with the progress we have made in the United States. Our land development and home-building activity in Texas performed well with 850 house sales last year. We have also established a significant presence in the Californian home-building market with the acquisition of Morrison Homes, one of the West Coast's larger home-building companies.

Property Development and Investment

The Group's property portfolio has been very rewarding over the years; nonetheless, partial ownership can inhibit effective management and severely restrict the marketability of the investments concerned. The Board has held the view for some time that, in general, Wimpey should conduct its property businesses either wholly owned or in joint ventures in which we can participate more actively in direction and management. Accordingly, during the year, holdings in associate companies and investments in the UK were rationalised, as previously announced.

Elsewhere during the year, our wholly-owned investment programme was strengthened and net rental income rose by £2.3 million to £8.8 million, while rent reviews currently under way may further increase income during 1984.

Outlook

I believe there is ample scope to build on the Group's underlying financial strength and strong position in a number of markets. Although recent organisational and management changes will take time to bear fruit, I am convinced that we are now set on the right course. Much depends on the prevailing economic circumstances both in the UK and overseas and, while some of our markets are reasonably buoyant, we are still feeling the effects of the worldwide recession in a number of areas.

Nevertheless, our workload is at a record level and I am confident in our capability to respond to the opportunities that will undoubtedly arise."

E. T. Sutherland joining USM

E. T. Sutherland and Son, a Sheffield-based chilled and canned meats company, yesterday announced details of its offer for sale on the Unlisted Securities Market.

It is offering 3.75m shares (25 per cent of the total) at 85p each. At that price, the group is capitalised at £14.25m, against a net asset value of £5.5m.

The offer includes 2m new shares, which will raise about £725,000 after expenses. The rest is being sold by the directors and their families. In the year to last December, profits rose by 19 per cent to £1.6m before tax on turnover up by 14 per cent to £20.5m.

There is no profits forecast, but the directors plan to pay a total dividend of 3.33p net for the current year, which gives a 5.01 per cent yield at the offer price. On an actual 40.4 per cent

tax charge, earnings were 6.49p per share last year, or £4.9m on a notional 50 per cent charge. On that basis, the historic multiples are 14.64 and 17.3 respectively.

The manufacture of chilled foods accounted for 62 per cent of turnover last year, and canned foods the remainder.

Samuel Montagu is the issuing house and brokers the transaction. Subscription lists open next Thursday and dealings are expected to begin on Friday May 11.

Comment

A long established family company with proven products in a stable industry makes unusual fare for the USM. In fact Sutherland could easily have gone to the upper house. As it is, the group is coming to the

USM on a slight premium to the rest of the food manufacturing sector. Nothing to do with the USM's heady atmosphere, but more a reflection of the major slice of turnover which is devoted to chilled meats, one of the fastest growing areas in the industry. There seems plenty of scope for Sutherland to extend its kingdom to the frozen spending south so long as it can maintain the quality of its unusual network of van drivers-cum-salesmen; an important key to its ability to hold its own against larger competitors. Offsetting the chilled meat side's obvious hot-weather bias is the canned food division, which is currently riding high on the growing demand for own-label canning. Despite Sutherland's staid image, it looks on track for a warm reception.

COMPANY NEWS IN BRIEF

Increased pre-tax profits of £605,000 compared with £351,000 have been produced by Norman Hay, electro-plater and anodiser, for 1983. Turnover expanded from £4.7m to £5.63m.

The net final dividend has been raised from 1.55p to 2.315p which lifts the total from 3.1p to 3.665p. Earnings per 10p share of this close company came to 8.3p (7.6p), after tax of £272,000 (£27,000).

British Vending Industries rose from £31,000 to £409,000 in 1983 and a final dividend of 0.25p raises the net total from 0.7p to 0.77p per 10p share.

Turnover reached £20.12m (£18.99m). With signs of economic recovery in the areas in which the group trades, substantial sales growth has been recorded in the first four months of 1984. Earnings per share for 1983 rose to 3.25p (2.75p).

Electro-Mechanics in 1983. The group is the sole agency in the UK for the distribution of Adler, Imperial and Triumph ranges of electronic typewriters, word processors and related equipment.

Turnover for the year was up at £24.37m (£23.76m) but operat-

ing profits were lower at £1.94m (£2.07m). Associate profits rose sharply from £8,657 to £172,452 and interest receivable was higher at £109,983 (£26,491).

An unchanged final dividend of 5p holds the total payout at 7.5p net per 25p ordinary. Earnings are shown as 23.06p (20.85p).

Tax takes £713,710 (£841,445) leaving attributable profits ahead at £1.41m (£1.28m), from which dividends will take £459,366 (same).

Stewart Nastra Group, a property holding company.

Turnover for the six months to end-December 1983 totalled £266,000 (£473,000). Sale of investment properties came to £422,000 (nil) and other activities incurred a £186,000 loss (profit £375,000). There is no tax payable (£195,000).

The company is 56 per cent owned by Bukharin Investments.

With all of the increase coming in the first half, taxable profits of chemicals, plastics and electronics concern Cole Group amounted to £427,000 for 1983, compared with £260,000.

Turnover, which rose from £18.47m to £22.18m for the 12 months, is ahead in the first quarter of the current year and indications are that this trend

should be maintained, the directors state.

After tax of £33,000 (£9,000 credit) earnings per 25p share were 12.1p, against 11p, and the dividend is stepped up from 3p to 4p with a final of 2.5p.

United Wire Group expanded from £171,000 to £242,000 for the half-year ended March 31 1984, but the interim dividend is maintained at 2.2p per share.

Turnover rose from £9.03m to £10.54m and although profits were after lower interest of £228,000 (£282,000) they were subject to tax, up from £77,000 to £230,000. Earnings per share were 6.41p (1.14p).

Agreement in principle has been reached for Scapa Group to acquire the company's South African subsidiary, Star Screens Pty, for £1.55m cash with effect from April 1.

Net asset value per share prior to charges at par at Lake View Investments rose to 321.3p against 244p for the year to the end of March 1984. At market value the figure came to 323.2p compared with 246.5p.

Earnings per 25p share came to 4.59p (4.54p) and a final net dividend of 2.85p (2.7p) raises the total from 4.25p to 4.4p. Income after tax came to £2,07m (£2,06m).

London & Scottish Marine Oil was increasingly looking to overseas for future growth—and not for entirely geological reasons, Mr Geoffrey Seale, the chairman, told the AGM.

The company, he said, was attracted to countries where the tax system was more favourable than in the UK and had a greater degree of fiscal certainty for high risk industries like oil exploration and production.

The chairman said LASMO planned to drill a near-record

CHANGE OF ADDRESS
S.G. Warburg & Co. Ltd.

Notice is hereby given to the holders of the securities listed below for which S.G. Warburg & Co. Ltd. acts as Fiscal, Paying or Warrant Agent that from 29th May, 1984 the specified office of S.G. Warburg & Co. Ltd. for the purposes of each of the issues listed will be:—

33 King William Street, London EC4R 9AS
Telephone: 01-280 2222. Telex: 22941

- Banco Nacional de Obras y Servicios Públicos, S.A.**
USS150,000,000
17½ per cent. Bonds 1992
- Caisses Nationale des Télécommunications**
£20,000,000.
12½ per cent. Guaranteed Notes 1989
- CIBA-GEIGY International Nederland B.V.**
£25,000,000
6½ per cent. Guaranteed Bonds 1993
- CIBA-GEIGY AG**
50,000 Warrants to subscribe for bearer participation certificates of CIBA-GEIGY AG
- Creditanstalt-Bankverein**
USS50,000,000
10½ per cent. Subordinated Notes due 1988
- Den norske Creditbank**
USS50,000,000
11½ per cent. Capital Notes due 1993
- Ente Nazionale per l'Energia Elettrica (ENEL)**
£100,000,000
Guaranteed Floating Rate Notes 1993
- WMC Finance Limited**
USS50,000,000
15½ per cent. Guaranteed Notes due 1988

- Mortgage Bank of Finland Ltd.**
£15,000,000
11½ per cent. Notes 1989
- Den Danske Provinsbank A/S ("Provinsbanken")**
USS25,000,000
Floating Rate Capital Notes 1990
- Schering International Finance B.V.**
£49,000,000
6½ per cent. Guaranteed Bonds 1990
- Schering Aktiengesellschaft**
98,000 Warrants to subscribe for Bearer Shares of Schering Aktiengesellschaft
- Société de Développement Régional**
£30,000,000
15½ per cent. Guaranteed Bonds 1992
- Toray Industries, Inc.**
USS50,000,000
10½ per cent. Guaranteed Bonds due 1987
- Toray Industries, Inc.**
10,000 Warrants to subscribe for Shares of Common Stock of Toray Industries, Inc.

Any such securities required to be presented or surrendered at S.G. Warburg & Co. Ltd. should, with effect from 29th May, 1984, be lodged at the new address.

UNAUDITED SUPPLEMENTARY FINANCIAL DATA

	1983	1982
Turnover of the Group and Share of Associates		
United Kingdom	822.0	716.0
North America	231.0	180.0
Near and Middle East	176.0	148.0
Elsewhere	251.0	196.0
	1480.0	1240.0
Abridged Balance Sheet		
Tangible Assets	290.8	260.1
Investments	63.6	112.6
	354.4	372.7
Work in Progress and Stocks	471.0	410.9
Net Debtors/(Creditors) (Excluding Finance) — Note (a)	(169.6)	(158.9)
Cash and bank balances	33.3	33.1
Assets Employed	689.1	662.8
Shareholders' Funds	476.4	506.3
Borrowings	183.1	147.7
Deferred Tax	23.9	6.0
Minority Interests	5.7	2.8
	689.1	662.8
Borrowings Less Cash	148.8	114.6
As % of Shareholders' Funds	31.1%	23%
Earnings Per Share — Note (b)	13.2p	13.7p
Dividends Per Share	3.05p	2.73p
Shareholders' Funds Per Share	169p	180p

Notes
(a) Debtors include £30.5 million outstanding in respect of the Group's interests in Euston Centre Properties PLC which has been received.
(b) 1982 data per share has been restated to reflect a 1 for 10 capitalisation issue of shares in 1983.

The Annual Report will be posted to all shareholders in late May. If you would like a copy, please send the coupon.

To: Corporate Relations Department, George Wimpey PLC, Hammersmith Grove, London W6 7EN.

Please send me your 1983 Annual Report

Name _____

Company/Address _____

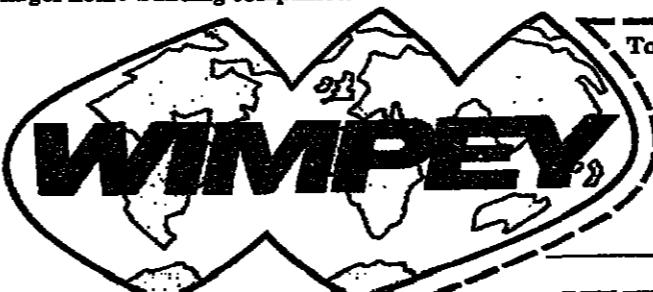

Clive Discount Holdings PLC

Results for the year ended 31st March 1984		1984 £'000	1983 £'000
Profits at £1.26m	Consolidated profit for the year after rebate, taxation, transfer to contingencies reserve and write-off of goodwill	1,260	1,850
Dividend up 12.5%	Dividends	904	734
Shareholders' Funds increase 18% to £9.5m	Transfer to Capital Reserve	356	1,116
		356	888
	Balance brought forward	2,000	1,112
	Balance carried forward	2,356	2,000

The directors recommend the payment of a final dividend of 2.90 (1.90) pence per share, payable on 15th June 1984, making a total for the year of 3.60 (3.20) pence per share.

The above results are an abridged version of the company's full accounts which carry an unqualified auditors' report and which have not yet been filed with the Registrar of Companies.

1 Royal Exchange Avenue, London EC3V 3LU
Telephone: 01-283 1101. Telex: 883431

MINING NEWS

RTZ hits at U.S. lobby for copper import curbs

BY KENNETH MARSTON, MINING EDITOR

"EXPERIENCE shows that temporary protectionist measures seldom, if ever, achieve their desired effects, whatever their sponsors originally claim, and as often as not turn out to be permanent."

With these words Sir Anthony Tuke, chairman of Rio Tinto-Zinc his out in the annual report of the UK-based mining and industrial group at moves afoot in the U.S. to protect the copper mines there from imported copper.

What concerns the U.S., and other copper producers is that while the copper market is depressed by heavy stocks and surplus mine capacity, third world countries such as Chile and Zambia exacerbate the situation by continuing to operate their Government-controlled mines at full capacity. They do so in order to earn much needed foreign exchange even though some of them operate at a loss. Bitterly, America's Phelps Dodge has said that such countries "can disregard their losses in large measure because the International Monetary Fund provides them credit to keep them, and their mines, in business."

Phelps, the major U.S. copper

producer, had a hard time in 1982 when because of uneconomic copper prices the company shut down all its mines for much of the year and suffered a loss of \$74.3m (\$52.6m). The entire U.S. copper industry cut back production by 25 per cent, but the Chilean state company, CODESA, raised output by 15 per cent to all-time high levels. Of 41 U.S. copper producers, including Phelps, and accounting for nearly 87 per cent of the domestic industry have petitioned the U.S. International Trade Commission for the position of temporary import

quotas for blister and refined copper.

Hearings on the petition are expected next month. Many observers think that it is unlikely to succeed. If it did, however, this would be a severe blow to non-U.S. companies such as RTZ and the Australian copper miners which would find themselves facing the brunt of Chilean and Zambian competition in a smaller market for copper.

Sir Anthony Tuke condemns such protectionist attitudes which have "contributed materially to the shrinking of world markets in the past decade. Not least among offenders is the United States which, while paying lip service to the virtues of free trade, has by its protectionist adversely affected world steel markets."

Regarding the outlook for RTZ this year, he repeats his earlier comment that it should be "satisfactory" providing that the economies of the Common Market countries continue on their present course and there is no adverse movements in exchange rates—notably a further weakening in the U.S. dollar—which would affect the revenue of this international group.

COMPANY NEWS

Tricentral profits slump to £8.6m

MAINLY reflecting a reduction in exchange gains of £2.9m, a worldwide increase in depletion and falling production from the Thistle Field, pre-tax profits of Tricentral oil, gas and mineral exploration concern, dropped from £14.3m to £8.6m for the first three months of 1984.

Turnover for the period amounted to £29.7m, against £29.5m, and excluded sales from trade in third party crude oil of £112m (£143.7m).

Production costs took £5.4m (£7.5m), depletion was higher at £10.5m compared with £8.1m (£12.8m), and oil trading £0.7m (£0.6m).

Operating profits of £10.4m (£13.2m) were split between oil and gas—UK £7.4m (£10.5m); U.S. £0.3m (£0.2m); Canada £2.7m (£1.8m); and oil trading £0.7m (£0.6m).

Petroleum revenue tax amounted to £0.6m (£0m) for the first quarter while corporate tax took £0.6m (£nil). Retained profit was £7.4m, compared with £3.2m (£2.5m) in the first quarter of 1983. Cash flow generated from operations, of £19.2m, was used mainly to increase fixed assets (£13.8m) and reduce debt (£7.1m).

Over the same period in 1983 Thistle production totalled 10,38m barrels (Tricentral 1.62m barrels). Last month the group acquired an 8.33 per cent working interest in an additional 12 Gulf of Mexico tracts for \$4.6m; the group now has a significant interest in 42 Federal leases in the Offshore Gulf of Mexico.

Tricentral is evidently due for a lower profit figure at the pre-tax level this year, if only because of the slow-down in Thistle production and disruptions in Buchan in the first quarter. A lower tax charge should lead to higher net earnings, though, of perhaps £27m. This puts the share down 2p at 208p—on a prospective P/E of about 7, well below the likes of LASMO and Charterhouse. But then, Tricentral is not the most popular oil company on the market. The extent to which this will change rests partly on how much will be realised by the sale of the U.S. interests, and on whether the Wythe Farm deal ever reaches completion. One might further argue that the company's greater concentration on North Sea exploration should improve the long-term production prospects. But the shares still have a poor market image, and such things can be slow to change.

Phelps Dodge still shows loss

AN EXTRAORDINARY CREDIT of U.S.\$25m (£17.6m) was not enough to return Phelps Dodge, the leading U.S. copper producer, to profits in the first quarter of this year.

The net loss for the latest period was \$5m, compared with a deficit of \$31.5m in the closing three months of 1983 and a loss of \$3.2m in the first quarter of that year.

The extraordinary credit arose out of the settlement of litigation between Phelps Dodge's Western Nuclear subsidiary and Washington Public Power Supply System, more generally known

as "Whoops" because of its sorry record of failure last year. The utility's financial problems forced it to cancel a uranium supply contract it had taken out with Western Nuclear.

Phelps Dodge said that the first quarter results reflect substantially lower copper prices than in the opening three months of last year. The company's spot price for cathodes averaged 64.8 cents per pound, compared with 73.9 cents. However, the latest price represents a slight improvement over the price of 63.8 cents in the fourth quarter of last year.

The latest results were also hit by higher unit costs. As in the first quarter of last year the company's higher cost mines were closed for the bulk of the period, and production was chiefly from higher-grade ores at the mine in Morenci, Arizona.

Mine production in the three months was 76,900 tons, up from 59,600 tons in the first quarter of last year. The mines at Ajo, Arizona, and Tyrone, New Mexico, which were closed in April 1982, were reopened in February and May 1983 respectively.

Union Bank of Switzerland Notice to Holders of the 4½% US\$ Convertible Bonds due May 15, 1987 Union Bank of Switzerland (Luxembourg), Luxembourg

At the Annual General Meeting held on April 5, 1984 the shareholders of Union Bank of Switzerland have approved to increase the share capital from Sfr. 1515 millions to Sfr. 1650 millions. The participation certificate capital will be increased in the same portion.

In conformity with the Terms and Conditions of the Bonds, the conversion price will therefore be reduced to

US\$ 97.69

with effect as of April 27, 1984.

Upon conversion of any Bond, there will be paid to the Bondholder in respect of each Bond delivered for conversion a sum in dollars equal to the difference between the principal amount of US\$ 1,200 of such Bond and the new conversion price.

Zurich, April 27, 1984.

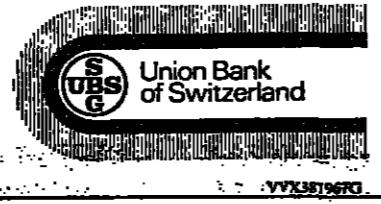

Sec. Code No. 583.048

MINING NEWS IN BRIEF

Canada's Westfield Minerals, part of the Northgate Exploration group, plans to transfer its worldwide oil and gas interests to a new European company, which will also acquire ownership of Megal of Ireland. Mogul holds mining leases over a former zinc, lead and silver mine in Tipperary, Ireland, and adjacent exploration leases.

A public financing for the new company is planned for mid-year. In addition, Westfield plans to start a diamond drilling programme on its Mishishiku Lake gold property, 15 miles south of Menawa, within a few days. Initial tests of the zone to be drilled showed a wide spread of assay values, ranging between 0.02

ounces (0.6 grammes) of gold per ton and 0.25 oz (7.8 grammes).

The restructuring of the U.S. silver mining industry which began three years ago with the purchase of Ray Mines by Hecla Mining continues with the news that Hecla is to transfer some of its interests in the silver-rich Coeur d'Alene district of Idaho to Sunshine Mining.

These interests include Hecla's 54 per cent stake in Chestnut Mining. Sunshine plans to withdraw its offer for all the shares of Ranchers Exploration and Development, which produces uranium, copper and gold as well as silver. Sunshine will,

however, exercise its option to acquire 7.7 per cent of Ranchers, and will then vote these shares in favour of the merger agreed between Ranchers and Hecla.

In addition, Hecla will cede its interest in part of the Sunshine silver mine in return for 2.25m Sunshine shares.

Mr Alfred Powis, chairman of Canada's Noranda Mines, said he expects the company to make profits of at least C\$100m (£35.6m) in 1984, compared with its operating loss of C\$9.5m in 1983. Shareholders will be asked to approve a change of the company's name to Noranda Incorporated at the annual meeting on May 4.

Success Story

Bunzl plc
Annual Report & Accounts 1983

Bunzl is a worldwide group of companies which trades in pulp and paper and manufactures and distributes filters, plastics, paper and packaging. Chairman Ernest Beaumont, reports: "The efforts of the last four years to reorganize the Group are now beginning to be reflected in rapid profits growth, earnings and return on investment". "Our mixture of activities is inherently strongly cash generating". "With most Group activities enjoying improving economic conditions, Group profits for the early part of 1984 are substantially ahead of the corresponding period of 1983".

Financial Highlights 1983:

- Turnover £541 million - up £179 million.
- Record profits of £17.3 million - up 36%.
- Earnings per share of 33.3p - up 32%.
- Annual Dividend of 11p per share - up 22%.
- Higher trading profits in all four Divisions.
- Significant profit contribution from acquisitions during the year.
- One-for-one Scrip Issue.

Please write or telephone for your copy of the 1983 Accounts:
D.C. Latimer, Secretary, Bunzl plc, Friendly House, 21-24, Chiswell Street, London EC1Y 4UD, United Kingdom. Tel: 01-505 9866, Telex: 888111.

Wm MORRISON SUPERMARKETS PLC

SUMMARY OF RESULTS (£000's)

	Year ended 28 January	
	1984	1983
Turnover	270429	223988
Operating profit	10049	8476
Profit before taxation	9991	8858
Profit after taxation	5882	4159
Earnings per share	12.7p	9.0p
Dividend per share	1.8p	1.6p

Copies of the 1984 Report and Financial Statements may be obtained from: The Secretary, Wm Morrison Supermarkets plc, Hillmore House, Thornton Road, Bradford BD8 9AX.

The better way to shop and save.

Granville & Co. Limited

Member of NASDIP
27/28 Lovat Lane London EC3R 8EB Telephone 01-621 1212

Over-the-Counter Market

1983-84	High	Low	Company	Price	Change	Gross	Yield	P/E	Fully
						Div. (p)	%		Actual
142	120	Ass. Bnt. Ind. Ord.	132	-	8.6	4.8	7.7	10.0	
147	117	Ass. Bnt. Ind. Ord.	144	-	10.0	8.0	10.0		
78	62	Alpsprung Group	63	-	8.1	8.7	18.0	18.0	
38	21	Armitage & Rhodes	32	-	7.2	2.2	12.4	27.1	
328	141	Baron Hill	128	+1	7.2	2.2	12.4	27.1	
68	53	Bay Technologies	64ud	-	3.5	5.5	6.3	9.0	
200	197	CCL Ordinary	200	-	5.0	2.5	4.5	6.3	
152	121	CCL 1½p Conv Prd.	152	-	15.0	10.0	15.0	15.0	
505	100	Carborundum Abrasives	505	-	5.7	1.1	-	-	
249	100	Cindico Group	109	-	17.8	17.0	-	-	
68	45	Debon Services	68	-	6.0	8.3	36	69	
217	75	Frank Horsell Pr Ord	217	+1	8.7	4.4	8.4	13.7	
199	75	Frank Horsell Pr Ord	189	-	8.7	4.4	8.4	13.7	
68	23	Frederick Parker	31	+4	4.3	13.3	-	-	
39	32	George Blair	38	-	17.1	4.7	-	-	
80	48	Ind Precision Castings	50	-	7.3	14.8	13.8	17.3	
2185	2150	Iata New Fully Pd Ord	2185	-	15.0	8.9	-	-	
356	124	Iata Conv Prd.	356	-	15.0	8.9	-	-	
121	81	Jackson Group	120	+1	4.5	3.8	6.3	12.3	
248	159	James Burrough	248	-	11.4	4.8	13.7	14.0	
338	225	Minhouse Holdings NV	335	-	4.0	1.0	23.7	32.2	
176	102	Robert Jenkins	102	-	20.0	18.5	11.8	6.0	
74	57	Scruttons "A"	57	-	6.7	10.0	8.5	8.9	
120	101	Tandry & Corliss	128	-	2.5	4.4	-	-	
444	385	Trevlen Holdings	444	-	-	-	8.9	8.2	
26	17	Unilever Holdings	18	-	1.0	5.5	11.8	17.1	
152	135	Water Alternatives	85	-	8.7	0.7	7.5	45.8	
270	230	W. S. Yates	246	+1	17.1	7.0	5.9	12.0	

WATMOUGHS (HOLDINGS) PLC

Another record year
1 for 5 scrip issue

	1983	1982	Increase
Group turnover	£22.5 million	£21.0 million	7%
Profit before tax	£2.1 million	£1.8 million	16%
Earnings per share	25.27p	21.94p	15%
Dividend per share	6.25p	5.21p*	20%

*Adjusted for the increased capital (1983 scrip issue—1 for 5)

Expansion of product range continues

- Additional gravure printing contracts obtained from mail order, travel, cosmetic, horticultural and publishing clients.
- Five new magazine contracts commence production in 1984.
- Security printing interests are growing rapidly.
- Packaging has attracted additional business from leading manufacturers of consumer goods.

We believe that further progress can be made in 1984 in all subsidiary companies in the group.

Annual report available from the Secretary, Idie, Bradford, West Yorkshire BD18 8NL.

Republic of Indonesia

U.S. \$75,000,000
Floating Rate Notes Due 1990

In accordance with the provisions of the Notes, notice is hereby given that the rate of interest for the period 27th April 1984 to 29th October 1984 has been fixed at 11½ per cent per annum and that the coupon amount payable on Coupon No. 4 will be U.S. \$9909.72.

Agent Bank
البنك السعودي العالمي المحدود
Saudi International Bank
AL-BANK AL-SAUDI AL-ALAMI LIMITED

هذا ما نريد

SECTION III - INTERNATIONAL MARKETS

FINANCIAL TIMES

Friday April 27 1984

NEW YORK STOCK EXCHANGE 34-36
AMERICAN STOCK EXCHANGE 35-36
U.S. OVER-THE-COUNTER 36, 44
WORLD STOCK MARKETS 36
LONDON STOCK EXCHANGE 37-39
UNIT TRUSTS 40-41
COMMODITIES 42 CURRENCIES 43
INTERNATIONAL CAPITAL MARKETS 44

WALL STREET

Brave face
put on
firm funds

A BRAVE FACE was adopted by many Wall Street investors yesterday despite continued firmness in the federal funds rate and diverging views on the outlook for interest rates, writes Terry Byland in New York.

The bond market struggled to hold a scattering of early gains while the underlying tone on the stock market, which opened sharply higher, remained optimistic. One major analyst described events as "a continuation of the beginning of the next leg of the bull market."

By 3.30 pm, the Dow Jones industrial average was 10.87 up at 1,174.20.

The stock market has been encouraged by the flow of excellent corporate trading results, and by dividend increases from several major names. But Wall Street also hopes that the pace of economic growth has slackened enough to take the upward pressures off interest rates. The test may come on Monday when the Commerce Department publishes its latest set of leading economic indicators.

The session opened with a rush of buying that put seven points on the Dow, with nearly 20m shares traded in the first half-hour. Both industrial and consumer issues were sought and

was added by a handful of takeover prospects.

IBM added 5/8 to \$112. General Motors 3/4 to \$86. General Electric 3/4 to \$55.5 and Sears, the general merchandiser, 3/4 to \$33. There was a brisk trade in Ford Motor 5/8 higher at \$35 1/2 ex-dividend.

Exxon added 3/4 to \$42 in response to the increased dividend while Occidental Petroleum, 3/4 up at \$31 1/2, had another active session. Standard Oil of

The closing report on Wall Street and updated U.S. market indicators were not available because of continuing industrial action at the Financial Times' printers in Frankfurt.

Ohio, controlled by British Petroleum, added 3/4 to \$48 1/2 after results.

Cummins Engine attracted buyers, rising 1 1/2 to \$78. Digital Equipment at \$90.4 recouped 3/4 of its recent losses and Texas Instruments sought again, with a rise of 3/4 to \$140 1/2.

Among consumer stocks, Dart & Kraft, the Tupperware to processed cheese group, put on 1 1/2 to \$76 1/2 in response to its results. Trading in Colgate-Palmolive calmed down, but a rise of 5/8 to \$25 1/2 was a response to suggest that the group could be a bid target.

The Limited, the unwanted suitor for Carter Hawley Hale, added 3/4 to \$19 1/2 and Schlumberger, the star of the oil exploration industry, gained 3/4 to \$54.

Mr Saul Steinberg's SEC filing of plans to increase his stake in Walt Disney, another favourite market takeover hope, sent Disney shares ahead 1 1/4 to \$63 1/2.

But in the financial stock sector, Gen-

eral Re, the reinsurance group, fell 1 1/2 to \$58 1/2 after results.

Other active issues included American Express, although it was unchanged at \$28 1/2 and K-mart, the discount store chain, 3/4 higher at \$30. Campbell Soup weakened 5/8 to \$60 1/2.

In the troubled electric utilities sector, there was a sharp fall in Texas Utilities, 3/4 off at \$22 1/2, on sudden nervousness over the regulatory prospects for the Comanche Peak plant which is still under construction.

On the American Stock Exchange, Gulf Canada gained 5/8 to \$14 1/2 with investors hoping that the corporate reporting season will bring some news on the expected disposal of the Canadian unit on completion of the takeover of Gulf U.S.

In the credit markets, the federal funds rate continued to move higher despite the round of system repurchases announced by the Fed on Wednesday. By midsession the funds rate was 10 1/2 per cent, a firmness that reflects technical pressures associated with the end of the tax year. The Fed has shown its willingness to supply reserves, and the pressures are expected to slacken within a short time.

Money market rates were mixed in quiet trading, and three-month Treasury bill discounts dipped by five basis points to 9.53 per cent, with the six-month down three basis points to 9.71 per cent.

The bond market looked patchy, with most prices a shade better despite continued lack of retail demand. The key 2013 long bond at 9 1/2% was 1/2 up on the day.

TOKYO

Matsushita
provides
the impetus

A FIRM tone remained among Tokyo stocks yesterday in a continuation of Wednesday's sharp rise, with Matsushita Electric Industrial group issues leading the way, writes Shigeo Nishitaki of Jiji Press.

The Nikkei-Dow market average topped 10,900 for the first time in seven days, closing at 10,901.52 up 35.18. Turnover stayed high at 446.52m shares, although down from Wednesday's 497.16m. Advances outnumbered losses 398 to 315, with 158 issues unchanged.

Matsushita group stocks soared after the announcement on Wednesday that consolidated recurring profit for the first quarter had surged 49 per cent. Kyushu Matsushita Electric advanced ¥410 to ¥3,600. Matsushita Communication Industrial ¥130 to ¥3,940 and Victor ¥110 to ¥7,860. Matsushita Electric Industrial posted a smaller rise of ¥30 to ¥1,920.

Matsushita's firmness spurred other leading blue chips, with Fanuc climbing ¥280 to ¥9,300 and Kyocera ¥50 to ¥5,880. But trading in blue chips remained slow.

Hitachi increased ¥16 to ¥955, while highly capitalised Nippon Steel gained ¥4 to ¥177 and Mitsubishi Heavy Industries ¥14 to ¥281 on buying by some investment trusts.

Large-asset issues were actively traded. Oji Paper firmed ¥15 to ¥541. Keihin Electric Express Railway ¥3 to ¥264 and Nippon Express ¥13 to ¥323. Tokuyama Soda jumped ¥12 to ¥577 on development of the world's first translucent aluminium nitride ceramic.

Topping the list of actives was Sumitomo Metal Mining with 18.22m shares and a ¥20 rise to ¥1,870. It was followed by Asahi Chemical with 15.63m, up ¥7 at ¥558; Nippon Express with 12.28m, ¥13 ahead at ¥323; and Mitsubishi Heavy Industries with 12.15m for a ¥14 gain at ¥261.

Despite the rally, investors seemed unlikely to return in force, as the market will be closed for three days next week for national holidays. Prices

tended to weaken after securities company dealers stopped buying, said a major securities house official.

The bond market eased on heavy sales of government bond holdings worth some ¥100bn by city banks, prompted by slack government bond turnover in April.

Reflecting the greater supply-demand imbalance, yields rose in the inter-broker market. The yield on the barometer 7.5 per cent 10-year government bonds maturing in January 1983 increased 2 basis points to 7.14 per cent.

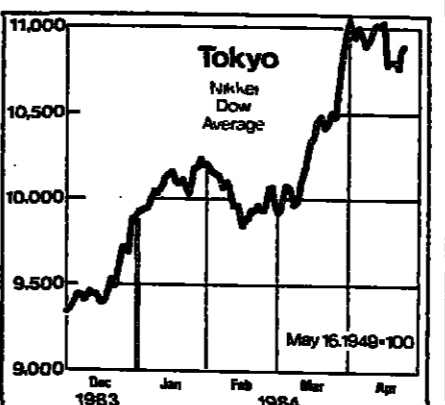

EUROPE
Stability
proves
no problem

STABILITY was maintained almost without exception on the European bourses yesterday, taking heart from Wall Street's overnight ability to hold on to the advance chalked up the previous session. While trading levels generally gained pace somewhat, prevailing sentiment seemed to preclude too quick a run-up and price changes were for the most part muted.

Early Frankfurt gains were unable to be sustained, and the outcome was mixed. Heightened labour tensions over the national 35-hour week campaign were viewed as having little impact, though.

Deutsche Bank, moving ex its one-for-12 rights issue, drew a favourable response and finished at DM 379.50

against Wednesday's DM 386.50, an effective rise of DM 3.50. Most others in the sector were firm too.

Porsche, expected to be a target for union disruption, was quoted in inter-bank dealings at between DM 1,050 and DM 1,070, slightly off from the previous DM 1,100 range but still well above the DM 780 flotation level.

A steady bond market allowed the Bundesbank to sell DM 10.4m in paper.

The return of Dutch institutional buying allowed Amsterdam a range of decent gains - among them FI 2.20 for Hoo-govens which reached FI 50 on the steel-maker's cheery 1984 outlook, and FI 1.10 in Royal Dutch at FI 158.10 as U.S. investors were reported as switching into the parent after tendering their Shell Oil holdings.

A first quarter at Phillips described by the board as "favourable" brought a FI 1.40 improvement to FI 49.60, while a FI 2.30 drop in KLM left it one of the few weak spots at FI 170.50.

Domestic bonds edged forward.

Paris had the benefit of a forecast from the Insee statisticians holding out the prospect of slowing inflation, and this helped turn a mixed opening into a brighter finish.

One cloud was the retreat to the courts by the Creusot Loire engineering group. It slid Ffr 5 to Ffr 30 before being suspended due to an excess of selling orders. Schneider, the parent, opened Ffr 4.50 down but losses were later curbed to Ffr 1.50 at Ffr 104.

Retailers were featured, with Au Printemps up Ffr 7.70 at Ffr 174.20.

Banks in Zurich managed modest but uniform gains, while results took Hoffmann-La Roche in chemicals SwFr 4,000 higher at SwFr 104,250. A dull Milan was enlivened only by foreign orders for Olivetti, which rose L105 to L4,719. The Swiss and Italian bond markets were both steady.

Electrolux was among the few firm Stockholm areas, SKR 3 ahead at SKR 269 as foreign selling persisted elsewhere. A cautious Copenhagen decline came in the wake of a government austerity package, with Novo off DKr 15 to DKr 2,440.

A marginally higher Brussels result had Sofina standing out with a Bfr 140 gain at Bfr 6,240 for a two-day advance of Bfr 230. Profit-taking in Cockerill Sambre took it Bfr 12 lower at Bfr 318.

Electrical utilities led a Madrid rally after the declines prompted by dividend curbs.

LONDON
Clearance
for assault
on peaks

GREEN LIGHTS were flashing yesterday for an assault on the highest levels ever reached by London equities. At one point it appeared that the FT Industrial Ordinary index would surpass last month's record 901.4, but it closed short of this at 899.1, a rise of 11.5 that extended the advance of the last two sessions to nearly 24 points. The FT-Actuaries All-Share index hit a new high of 532.18, a rise of 0.8 per cent while the FT-SE 100 gained 11.1 to 1,130.9.

Encouraging trading announcements from several major groups gave the market its impetus. ICI rose 14p to 620p on higher than expected first-quarter profits.

Gilts were unaffected by Wednesday's sharp rise in U.S. federal funds.

Chief price changes, Page 36; Details, Page 37; Share information service, Pages 38-39

KEY MARKET MONITORS

STOCK MARKET INDICES			
	April 26	Previous	Year ago
NEW YORK			
DJ Industrials	1174.20*	1163.53	1209.46
DJ Transport	497.55*	494.55	523.98
DJ Utilities	125.24*	125.24	126.43
S&P Composite	159.78*	158.65	161.81
LONDON			
FT Ind Ord	899.1	887.6	898.8
FT-SE 100	1130.9	1119.8	949.4
FT-A All-share	532.18	527.79	441.08
FT-A 500	579.05	573.95	479.84
FT Gold mines	693.9	698.0	696.8
FT-A Long gilt	10.25	10.27	10.47
TOKYO			
Nikkei-Dow	10,901.52	10,866.34	8807.47
Tokyo SE	854.49	850.20	624.42
AUSTRALIA			
All Ord	752.9	759.1	603.0
Metals & Mins.	533.8	542.0	545.8
AUSTRIA			
Credit Aktien	54.95	54.97	56.01
BELGIUM			
Belgian SE	155.06	154.69	122.15
CANADA			
Toronto Composite	2326.4*	2319.7	2321.3
Montreal Industrials	420.92*	419.7	397.04
Combined	357.07*	355.95	358.87
DENMARK			
Copenhagen SE	194.84	196.16	137.46
FRANCE			
CAC Gen	175.1	174.4	117.8
Ind. Tendence	111.4	110.9	72.8
WEST GERMANY			
FAZ-Aktien	352.03	351.18	318.09
Commerzbank	1028.5	1026.4	952.1
HONG KONG			
Hang Seng	1070.7	1082.72	1028.29
ITALY			
Banca Comm.	216.99	216.78	190.98
NETHERLANDS			
ANP-CBS Gen	162.4	158.8	125.5
ANP-CBS Ind	127.9	126.7	104.7
NORWAY			
Oslo SE	283.0	281.05	182.52
SINGAPORE			
Straits Times	1003.37	1004.38	932.75
SOUTH AFRICA			
Gold	n/a	1042.8	918.9
Industrials	n/a	1070.5	927.3
SPAIN			
Madrid SE	115.37	114.47	109.38
SWEDEN			
J & P	1505.26	1510.33	1390.27
SWITZERLAND			
Swiss Bank Ind	376.2	372.4	322.0
WORLD			
Capital Int'l	187.4	186.6	174.1
GOLD (per ounce)			
London	323.75	323.75	328.75
Frankfurt	337.75	337.75	338.25
Zurich	337.25	338.25	338.25
Paris (Mark)	5381.25	5381.62	5381.62
Luxembourg (franc)	5382.40	5382.75	5382.75
New York (May)	3369.50*	3369.50	3369.50

CURRENCIES			
	April 26	Previous	April 26
U.S. DOLLAR			
(London)	1.00	1.00	1.00
STERLING			
DM	2.8985	2.6795	3.785
Yen	226	225.65	317.25
FFr	8.2725	8.2275	11.805
SwFr	2.227	2.217	3.1275
Guilder	3.038	3.0225	4.265
Lira	1667	1654.0	2338
BFR	54.92	54.5	77.05
CS	1.27915	1.27965	1.7935
INTEREST RATES			
Euro-currencies			
(3-month offered rate)			
£	8%	8%	
SwFr	3 3/4%	3%	
DM	5 1/2%	5%	
FFr	12%	13%	
FT London Interbank fixing			
(offered rate)			
3-month U.S.S	11 1/2%	11%	
6-month U.S.S	11 1/2%	11%	
U.S. Fed Funds			
10% 3-month CDs	10.60*	10.55	
U.S. 3-month T-bills	9.53*	9.58	
U.S. BONDS			
Treasury			
April 26			
Price	Yield	Price	Yield
11 1/2 1986	99 3/4	11.65	99 1/2
12 1/2 1991	99 3/4	12.57	99
11 7/8 1993	95 1/2	12.65	95
12 2013	94 1/2	12.70	94 1/2
Corporate			
AT & T			
10% June 1990	90%	12.75	90%
3% July 1990	70%	10.40	70%
8% May 2000	70%	13.25	70%
Xerox			
10% March 1993	86%	13.15	87%
Diamond Shamrock			
10% May 1993	86%	13.25	86%
Federated Dept Stores			
10% May 2013	80	13.35	79%
Abbott Lab			
11.80 Feb 2013	88%	13.30	88%
Alcoa			
12% Dec 2012	85%	13.70	89%
FINANCIAL FUTURES			
CHICAGO			
U.S. Treasury Bonds (CBT)			
3% 20nds of 100%			
June	65-16	65-22	65-12
U.S. Treasury Bills (TMM)			
3m points of 100%			
June	90.13	90.16	90.10
Sept	90.13	90.16	90.11
Certificates of Deposit (TMM)			
3m points of 100%			
June	89.11	89.14	89.05
LONDON			
Three-month Eurodollar			
3m points of 100%			
June	88.98	88.98	88.92
20-year Notional Gilt			
£50,000 32nds of 100%			
June	107-10	107-20	107-08
COMMODITIES			
(London)			
April 26			
Prev			
Silver (spot fixing)	552.95p	552.95p	555.20p
Copper (cash)	£1045.00	£1050.00	1050.00
Coffee (May)	£206.00	£205.40	205.40
Oil (spot Arabian Light)	529.40	528.32	

INITIAL OFFER OF UNITS

United States shares set to recover lost ground.

Perpetual launch a new Offshore Unit Trust based on the free world's largest economy

The initial offer of units is from 21 April 1984 until 5 May 1984 at the initial offer price of US \$1 (minimum subscription US \$2000). Thereafter units are dealt in on Tuesdays. The initial estimated annual yield is 0.7%.

Opportunity from US equities

The current weakness in US equity markets caused by interest rates, the budget deficit, and political considerations, are at odds with healthy progress being made by an economy that has moved from a recovery phase into a period of steady growth. Strong growth in the Gross National Product over four consecutive quarters, a sharp increase in personal incomes, and the Index of Consumer Expectations near its highest point, are indicators that despite the recent retreat in share value, the US economy is in good order.

Recent signs of slowing economic growth should be regarded as healthy, as previous growth levels would be unsustainable without fueling inflation and creating economic bottlenecks.

Most of the current problems are understood by investors and have been largely discounted in share prices. We believe that the American bull market is not over, and the current corrective phase that began last June is nearly complete. We consequently believe it possible that US equities are nearing the bottom of their trading range and we see excellent value among many North American shares.

In the light of this assessment of the current position of the US and Canadian economies we are launching the Offshore American Fund.

Perpetual - consistent success

The Perpetual Group have earned an enviable reputation for consistent investment success over their 10 year history. The UK based Growth Fund is the UK's most successful authorised unit trust for capital growth over the period since launch on 11 September 1974 to 31 March 1984 - up 144% compared to a rise in the Capital International Index of 41% (both figures allow for net reinvested income and are currency adjusted).

The Offshore Growth Fund, based in Jersey, Channel Islands, was launched on 25 January 1983 and by 31 March 1984 the offer price of units had risen by 30.8% compared to a rise in the Capital International Index of 24.0%.

Each of the remaining funds under Perpetual management have also performed well against any reasonable comparison, and the investment results generally reflect an exposure to North American markets where, during the last 10 years, as much as 45% of funds have, at times, been invested.

The result of this consistently successful investment performance is that Perpetual have become one of Britain's most popular Unit Trust Managers, with funds under management now exceeding Sterling £100m.

Note: These results are a mixture of second and third order data and should not be construed as a guarantee of future success. Rates throughout refer to the offer price of units, and the Growth Fund and Capital International Index figures include net reinvested income. All figures are for the period ending 31 March 1984.

Perpetual Group Offshore American Fund

Please send me a copy of the Perpetual Group Offshore American Fund prospectus (on the terms of which alone all applications will be accepted).
To: Perpetual Unit Trust Management (Jersey) Limited, PO Box 459, Commercial House, Commercial Street, St Helier, Jersey, Channel Islands.
Tel: Jersey (0534) 74517 & 72177.
Telex: 4192097 SCTCIG.

NAME _____
INITIALS/Mr/Ms/Mrs _____
ADDRESS _____

Perpetual
Britain's Fast Growing Unit Trust Managers

Prices at 3pm, April 26

NEW YORK STOCK EXCHANGE COMPOSITE PRICES

Main table containing stock prices for various companies, organized into columns with headers like '12 Month High', 'Low', 'Stock', 'Div. Yld.', 'P/E', 'Vol.', 'Open', 'Close', 'Change', 'Prev. Close'. Includes sub-sections for 'G-G-G', 'D-D-D', 'E-E-E', 'H-H-H', 'M-M-M', 'P-P-P', 'I-I-I', 'J-J-J', 'K-K-K', 'L-L-L', 'N-N-N', 'O-O-O', 'R-R-R', 'S-S-S', 'T-T-T', 'U-U-U', 'V-V-V', 'W-W-W', 'X-X-X', 'Y-Y-Y', 'Z-Z-Z'.

Continued on Page 35

Handwritten signature: J. J. ...

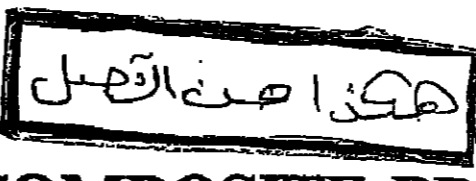

AMERICAN STOCK EXCHANGE COMPOSITE PRICES

Prices at 3pm, April 26

Main table of American stock exchange composite prices, listing various stocks and their prices.

Continued on Page 36

NEW YORK STOCK EXCHANGE COMPOSITE PRICES

Main table of New York stock exchange composite prices, listing various stocks and their prices.

Sales figures are unaudited. Yearly highs and lows reflect the previous 52 weeks plus the current week, but not the latest trading day. Where a split or stock dividend amounting to 25 percent or more has been paid, the year's high and low range and dividend rates are shown for the new stock only. Unless otherwise noted, rates of dividends are annual distributions based on the latest declaration.

WORLD VALUE OF THE DOLLAR every Friday in the Financial Times

WORLD STOCK MARKETS

Table of world stock markets including Austria, Germany, Norway, Australia, and Japan. Columns include country, date, price, and change.

OVER-THE-COUNTER

Table of over-the-counter stock prices with columns for stock name, price, and change. Includes sub-sections for LONDON and various market indices.

Table of American stock exchange prices for Toronto, listing various stocks and their prices.

Table of international guide to the arts, listing various art-related items and their prices.

Table of American stock exchange prices, continued from the previous section, listing more stocks and their prices.

Table of indices, including New York Dow Jones and Standard and Poors, with columns for date and index value.

Handwritten signature or note at the bottom of the page.

LONDON STOCK EXCHANGE

MARKET REPORT

RECENT ISSUES

Encouraging trading statements accelerate advance and equity index nears 900

Account Dealing Dates

*First Declara. Last Account Dealings... Apr 9 Apr 26 Apr 27 May 8...

The green lights were flashing brightly yesterday for an assault on the highest levels ever reached by London equities...

Barclays feature... Receding rights issue fears following Barclays' and Midland's annual meetings...

FT-ACTUARIES SHARE INDEX

These indices are the joint compilation of the Financial Times, the Institute of Actuaries and the Faculty of Actuaries

Table with columns: EQUITY GROUPS & SUB-SECTIONS, Thurs April 26 1984, Wed April 25, Thurs April 24, Thurs April 19, Thurs April 18, Year ago (approx.)

FIXED INTEREST

Table with columns: PRICE INDICES, Thurs April 26, Wed April 25, Thurs April 24, Thurs April 19, Thurs April 18, Year ago (approx.)

FINANCIAL TIMES STOCK INDICES

Table with columns: Government Secs, Fixed Interest, Industrial Ord., Gold Mines, Ord. Div. Yield, Earnings, P/E Ratio, Total Bargains, Equity turnover, Shares traded

HIGHS AND LOWS S.E. ACTIVITY

Table with columns: Govt. Secs, Fixed Int., Ind. Ord., Gold Mines, High, Low, Since Compilat'n, Daily Edged, Edged, 5-day Average, Edged, 5-day Average, Bargains, Value

secondary counters again centred on Newsagents. Martin subject of much interest recently advanced to 210p...

Trafalgar House up

Trafalgar House advanced 14 to 256p following news that the chain has bought the leasehold interest in the Cunard Hotel Bristol for £2m...

European Options Exchange

Table with columns: Series, Vol., Last, Vol., Aug., Last, Vol., Nov., Last, Stock

Norman Hay gained 3 to 7p after their satisfactory annual profit performance...

Cheaper-priced issues and marginal stocks continued to attract persistent support...

Advertising issues featured Saatchi and Saatchi which advanced 7 1/2p following publicity given to bullist...

Bryson Oil advance

Irish-domiciled oils provided a firm feature in Bryson Oil and gas which rose ahead to close 45 pence...

Gold firm

South African Golds were unperturbed by the latest decline in the bullion...

EQUITIES

Table with columns: Issue Price, Amount Offered, Latest Renewal, High, Low, Stock, Closing Price, % Chg

FIXED INTEREST STOCKS

Table with columns: Issue Price, Amount Offered, Latest Renewal, High, Low, Stock, Closing Price, % Chg

OPTIONS

Table with columns: First Declara, Last For Deal, Last For Declara, Last For Settling, Stock, Closing Price, % Chg

"RIGHTS" OFFERS

Table with columns: Issue Price, Amount Offered, Latest Renewal, High, Low, Stock, Closing Price, % Chg

NEW HIGHS AND LOWS FOR 1984

Table with columns: NEW HIGHS (14), NEW LOWS (33), Stock, Closing Price, % Chg

WEDNESDAY'S RISES AND FALLS

Table with columns: Active Stocks, Rises and Falls Yesterday, Stock, Closing Price, % Chg

FT - SE 100 INDEX

Table with columns: Close, Day's High, Day's Low, Bass Value = 1000 December 30 1983

LONDON TRADED OPTIONS

Table with columns: Option, Calls, Puts, Option, Calls, Puts, Option, Calls, Puts

FT LONDON SHARE INFORMATION SERVICE

HOTELS—Continued

Table with columns: 1968 High, 1968 Low, Stock, Price, Div, Yield, etc. for various hotel stocks.



BRITISH FUNDS

Table of British Funds including 'Shorts' (Lives up to Five Years) and Five to Fifteen Years categories.

Over Fifteen Years

Table of funds categorized as 'Over Fifteen Years'.

Undated

Table of undated funds.

Index-Linked

Table of index-linked funds.

INT. BANK AND O'SEAS GOVT STERLING ISSUES

Table of international bank and overseas government sterling issues.

CORPORATION LOANS

Table of corporation loans.

COMMONWEALTH AND AFRICAN LOANS

Table of commonwealth and African loans.

LOANS

Table of general loans.

Public Board and Ind.

Table of public board and industrial loans.

Financial

Table of financial instruments.

FOREIGN BONDS & RAILS

Table of foreign bonds and rails.

AMERICANS

Table of American stocks.

BUILDING INDUSTRY, TIMBER AND ROADS

Table of building industry, timber, and roads stocks.

DRAPERY & STORES—Cont.

Table of drapery and stores stocks.

ENGINEERING—Continued

Table of engineering stocks.

INDUSTRIALS (Miscel.)

Table of miscellaneous industrial stocks.

ELECTRICALS

Table of electrical stocks.

CANADIANS

Table of Canadian stocks.

BANKS, HP & LEASING

Table of banks, hire purchase, and leasing stocks.

CHEMICALS, PLASTICS

Table of chemicals and plastics stocks.

FOOD, GROCERIES, ETC

Table of food, groceries, and other stocks.

DRAPERY AND STORES

Table of drapery and stores stocks.

ENGINEERING

Table of engineering stocks.

BEERS, WINES & SPIRITS

Table of beer, wine, and spirit stocks.

HOTELS AND CATERERS

Table of hotel and caterer stocks.

Self is Ltd

INDUSTRIALS—Continued

Table of industrial stock prices including companies like BHP, Anglo American, and various mining firms.

LEISURE—Continued

Table of leisure stock prices including companies like British Airways, British Telecom, and others.

PROPERTY—Continued

Table of property stock prices including companies like British Land, Guinness, and others.

INVESTMENT TRUSTS—Cont.

Table of investment trusts including various funds like the British Venture Fund and others.

OIL AND GAS—Continued

Table of oil and gas stock prices including companies like Shell, BP, and others.

MOTORS, AIRCRAFT TRADES

Table of motor and aircraft trade stock prices including companies like British Leyland and others.

MOTORS AND CYCLES

Table of motor and cycle stock prices including companies like Honda and others.

SHIPPING

Table of shipping stock prices including companies like P&O and others.

SHOES AND LEATHER

Table of shoes and leather stock prices including companies like Burberry and others.

SOUTH AFRICANS

Table of South African stock prices including companies like Anglo American and others.

NEWSPAPERS, PUBLISHERS

Table of newspaper and publisher stock prices including companies like News Corp and others.

TEXTILES

Table of textile stock prices including companies like J. & F. S. and others.

PAPER, PRINTING

Table of paper and printing stock prices including companies like Newsprint and others.

OVERSEAS TRADERS

Table of overseas trader stock prices including companies like Jardines and others.

PLANTATIONS

Table of plantation stock prices including companies like Guthrie and others.

INSURANCES

Table of insurance stock prices including companies like Prudential and others.

PROPERTY

Table of property stock prices including companies like British Land and others.

TOBACCO

Table of tobacco stock prices including companies like British American Tobacco and others.

TRUSTS, FINANCE, LAND

Table of trusts, finance, and land stock prices including various funds and companies.

TEAS

Table of tea stock prices including companies like Tetley and others.

INSURANCES

Table of insurance stock prices including companies like Prudential and others.

PROPERTY

Table of property stock prices including companies like British Land and others.

TOBACCO

Table of tobacco stock prices including companies like British American Tobacco and others.

TRUSTS, FINANCE, LAND

Table of trusts, finance, and land stock prices including various funds and companies.

TEAS

Table of tea stock prices including companies like Tetley and others.

INSURANCES

Table of insurance stock prices including companies like Prudential and others.

PROPERTY

Table of property stock prices including companies like British Land and others.

TOBACCO

Table of tobacco stock prices including companies like British American Tobacco and others.

TRUSTS, FINANCE, LAND

Table of trusts, finance, and land stock prices including various funds and companies.

TEAS

Table of tea stock prices including companies like Tetley and others.

INSURANCES

Table of insurance stock prices including companies like Prudential and others.

PROPERTY

Table of property stock prices including companies like British Land and others.

TOBACCO

Table of tobacco stock prices including companies like British American Tobacco and others.

TRUSTS, FINANCE, LAND

Table of trusts, finance, and land stock prices including various funds and companies.

TEAS

Table of tea stock prices including companies like Tetley and others.

INSURANCES

Table of insurance stock prices including companies like Prudential and others.

PROPERTY

Table of property stock prices including companies like British Land and others.

TOBACCO

Table of tobacco stock prices including companies like British American Tobacco and others.

TRUSTS, FINANCE, LAND

Table of trusts, finance, and land stock prices including various funds and companies.

TEAS

Table of tea stock prices including companies like Tetley and others.

DAIWA BANK advertisement with logo and contact information.

MINES—Continued

Table of mining stock prices including companies like Anglo American and others.

NOTES

Text providing information about bank notes and financial instruments.

REGIONAL & IRISH STOCKS

Table of regional and Irish stock prices including companies from various regions.

OPTIONS—3-month call rates

Table of 3-month call option rates for various stocks.

Central African

Table of Central African stock prices including companies from the region.

Finance

Table of finance stock prices including companies like banks and financial institutions.

Diamond and Platinum

Table of diamond and platinum stock prices including companies in the industry.

Central African

Table of Central African stock prices including companies from the region.

AUTHORISED UNIT TRUSTS

Table listing various unit trusts such as Albion Unit Trst, Albion Unit Trst (2), Albion Unit Trst (3), etc., with columns for name, manager, and other details.

Table listing unit trusts under the heading 'British Inv. Co. Unit Trusts Ltd (a) (c) (d)', including names like British Inv. Co. Unit Trusts Ltd, British Inv. Co. Unit Trusts Ltd (2), etc.

Table listing unit trusts under the heading 'Greenwich Unit Trust Services Ltd', including names like Greenwich Unit Trust Services Ltd, Greenwich Unit Trust Services Ltd (2), etc.

Table listing unit trusts under the heading 'Legal & General Unit Trst. (Mgmt.) Ltd', including names like Legal & General Unit Trst. (Mgmt.) Ltd, Legal & General Unit Trst. (Mgmt.) Ltd (2), etc.

Table listing unit trusts under the heading 'Midland Bank Group U.T. Mgmt. Ltd', including names like Midland Bank Group U.T. Mgmt. Ltd, Midland Bank Group U.T. Mgmt. Ltd (2), etc.

Table listing unit trusts under the heading 'Saver & Prosper Group', including names like Saver & Prosper Group, Saver & Prosper Group (2), etc.

Table listing unit trusts under the heading 'Various other unit trusts', including names like Various other unit trusts, Various other unit trusts (2), etc.

Table listing various insurance policies and providers, including names like Albion Life Assurance Co Ltd, Albion Life Assurance Co Ltd (2), etc.

Table listing insurance policies under the heading 'Insurance - continued', including names like Albion Life Assurance Co Ltd, Albion Life Assurance Co Ltd (2), etc.

Table listing insurance policies under the heading 'Various other insurance policies', including names like Various other insurance policies, Various other insurance policies (2), etc.

Table listing insurance policies under the heading 'Various other insurance policies', including names like Various other insurance policies, Various other insurance policies (2), etc.

Table listing insurance policies under the heading 'Various other insurance policies', including names like Various other insurance policies, Various other insurance policies (2), etc.

Table listing insurance policies under the heading 'Various other insurance policies', including names like Various other insurance policies, Various other insurance policies (2), etc.

Table listing insurance policies under the heading 'Various other insurance policies', including names like Various other insurance policies, Various other insurance policies (2), etc.

Table listing insurance policies under the heading 'Various other insurance policies', including names like Various other insurance policies, Various other insurance policies (2), etc.

Table listing insurance policies under the heading 'Various other insurance policies', including names like Various other insurance policies, Various other insurance policies (2), etc.

F.T. CROSSWORD PUZZLE No. 5402. 1 Acrobat often seen on the bars (7). 2 Chatterer acting strangely about love (7). 3 Lumpy part of eastern odyssey (5). 4 Going down to a bargain department (9). 5 I join car-makers in Venice, perhaps - this can be shown (8). 6 Encounters in France. (5). 7 No water for frigate canoe (5). 8 Brown layer of Greater London (9). 9 Bird - one that does not fly - rarely seen close to peacocks (9-6). 10 Nothing in beers to make them purgative (5). 11 Paper in strips? That is funny! (5). 12 Rather slow half of Poplar has poor quarry (9). 13 Standard that French attempt in polished flourish (9). 14 Health area grant (5). 15 Could be three at Cambridge (7). 16 Colourful horse swallows medal - who could fish it out? (7). 17 Cross to break goal-net? (7). 18 Skill of delivery assistants? (8). 19 This time, I call out some of Schubert's music, just for show (5). 20 New blood-rack needed - arterial obstruction here (4-5). 21 Stretch neck of bird (5). 22 The halo madness? (9).

7 Even I can make a list of 14. 24 Firm admitting nothing in big store (5). Solution to Puzzle No. 5401. A crossword puzzle grid with numbers 1 through 24 indicating starting positions for the clues.

Various financial data and news snippets, including mentions of 'Saver & Prosper', 'Legal & General', and 'Midland Bank'.

Various financial data and news snippets, including mentions of 'Saver & Prosper', 'Legal & General', and 'Midland Bank'.

Various financial data and news snippets, including mentions of 'Saver & Prosper', 'Legal & General', and 'Midland Bank'.

Various financial data and news snippets, including mentions of 'Saver & Prosper', 'Legal & General', and 'Midland Bank'.

Various financial data and news snippets, including mentions of 'Saver & Prosper', 'Legal & General', and 'Midland Bank'.

Various financial data and news snippets, including mentions of 'Saver & Prosper', 'Legal & General', and 'Midland Bank'.

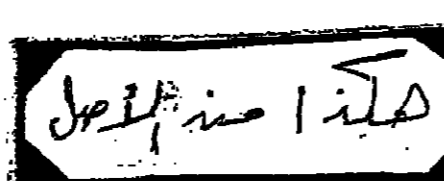

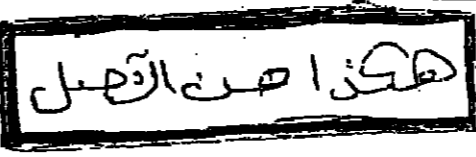

INSURANCE & OVERSEAS MANAGED FUNDS

Table listing various insurance and managed funds, including company names, fund names, and numerical values.

Table listing various insurance and managed funds, including company names, fund names, and numerical values.

Table listing various insurance and managed funds, including company names, fund names, and numerical values.

Table listing various insurance and managed funds, including company names, fund names, and numerical values.

OFFSHORE AND OVERSEAS

Table listing offshore and overseas managed funds, including company names, fund names, and numerical values.

NOTES: Price is in pence unless otherwise stated and all figures are in pence unless otherwise stated.

COMMODITIES AND AGRICULTURE

Broken Hill halts lead smelting

BY JOHN EDWARDS, COMMODITIES EDITOR

BROKEN HILL Associated Smelters, the Australian metal producer, confirmed yesterday that it would stop lead smelting at its Port Pirie plant on May 4 because of the continued closure of the Broken Hill silver, lead and zinc mines.

The company has been using up concentrate stocks since the mines closed on March 28 following an industrial dispute. Port Pirie is an important source of primary lead supplies with normal production of about 4,500 tonnes a week.

Meanwhile, Asarco of the U.S. announced that it would resume operations at its Glover lead smelter in Missouri next month.

Sharp rise in potato futures prices

By Our Commodities Staff

POTATO futures prices on the London market moved up sharply yesterday, reflecting growing doubts about the prospects for the orderly liquidation of the prompt April position which expires on Monday.

Mr Richard Osborne, president of Asarco, told the company's annual meeting in New York that he did not expect lead prices to rise much above present levels. He said there was a large stockpile of lead in the form of spent batteries which could be recycled if values increased further.

Stern words on horn versus corn

THE EEC Commission, having thoroughly sapped the confidence of Britain's dairy farmers with the hurried imposition of milk quotas, has turned its attention to the arable sector.

The Commission has always been rather ambivalent about cereals. In the early days there was a theory that the output of livestock products could be controlled by manipulating the price of grain, but this was never put to the test.

Faced with this situation, what can the sensible cereal farmer do? It is useless for the individual to cut production. It will only make room for someone else to produce surplus and he will still receive price based on the market.

Farmer's Viewpoint: By John Cherrington

production, grain support is much cheaper than milk support. Even with the imposition of the quota, milk will be costing about £120 a year per cow. EEC cereal support for 1983 was budgeted at about £0.50 a tonne. On an average basis this would be about £25 an acre against over £100 an acre for milk.

money. The premiums paid reflect the state of market demand and have little to do with quality. Farmers have learnt this and know that the best option is to grow the high yield given by the feed varieties. It would take the offer of a very high premium indeed to make me plump for what the millers and malsters say they really want.

Ghana calls for joint stance on cocoa pact

By Peter Blackburn in Abidjan

A JOINT stance in next month's negotiations to renew the International Cocoa Agreement is the main subject being discussed during a visit to the Ivory Coast by Ghana's Agriculture Minister, Mr John N'Debagre.

Speaking after talks with President Houphouët Boigny in Abidjan, Mr N'Debagre said: "Our people suffer from a steady deterioration in purchasing power and it is high time we strengthened relations in order to defend our common interest."

Grain surpluses attacked

BY JOHN EDWARDS, COMMODITIES EDITOR

GRAIN producers in the European Community are "heebent" on creating the same oversupply catastrophe that has hit the milk sector, Mr R. E. R. Tyrell, president of the European Agricultural Association, warned last night.

Speaking at the association's annual dinner in London, Mr Tyrell said present proposals would do little or nothing to arrest over-production and the cereals sector could expect to follow the dairy sector in having severe restrictions placed on production.

French minister warns U.S. against attacks on CAP

BY NANCY DUNNE IN WASHINGTON

MICHEL Rocard, the French Agriculture Minister, has issued a strongly worded warning that U.S. attacks on the Common Agricultural Policy could lead to the crumbling of the EEC.

British commodity prices

By Our Commodities Staff

Nickel—Morning: Cash £3,457, three months £3,200, 25, 20, 27, 34, 20. Afternoon: Three months £3,225, 20, 27, 34, 20. Spot: Three months £3,225, 20, 27, 34, 20. 12 months £3,225, 20, 27, 34, 20.

American markets

By Our Commodities Staff

NEW YORK, April 26.—Cotton futures prices were lower on Friday through liquidation by a commercial house but found some support, which pushed the day's losses.

Table with columns: In tonnes, Apr. 26, Apr. 25, + or -, Month ago. Rows include Metals (Aluminum, Copper, Zinc), Oil (Crude, Gas), and other commodities.

BRITISH COMMODITY PRICES

Table with columns: Commodity, Price, Change. Rows include Base Metals (Copper, Lead, Zinc), Grains (Wheat, Barley), and other commodities.

AMERICAN MARKETS

Table with columns: Commodity, Price, Change. Rows include Wheat, Corn, Soybeans, and other commodities.

NEW YORK

Table with columns: Commodity, Price, Change. Rows include Cotton, Sugar, and other commodities.

LONDON OIL

Very good commission house buying during the morning pushed the market quickly higher. Conflicting rumours about the Iranian situation and the Gulf provided some nervousness.

Table with columns: Commodity, Price, Change. Rows include Crude Oil, Gas Oil, and other oil products.

COFFEE

In quiet conditions early losses were erased as chart-based support and a recovery report from Drexel Burnham Lambert.

Table with columns: Commodity, Price, Change. Rows include Coffee (Arabica, Robusta) and other commodities.

INDICES

FINANCIAL TIMES: Apr. 26, 1984. DOW JONES: Apr. 26, 1984.

Table with columns: Index Name, Value, Change. Rows include FTSE 100, Dow Jones, and other indices.

CHICAGO

LIVE CATTLE 40,000 lb, cents/lb. LIVE HOGS 30,000 lb, cents/lb.

Table with columns: Commodity, Price, Change. Rows include Live Cattle, Live Hogs, and other commodities.

GOLD MARKETS

Gold fell \$6 to \$376.377 on the London bullion market, influenced by the firmer dollar.

Table with columns: Commodity, Price, Change. Rows include Gold Bullion, Gold Bars, and other gold products.

LEAD

Lead—Morning: Cash £235.5, three months £245.5, 43.5, 43.5, 43.5.

Table with columns: Commodity, Price, Change. Rows include Lead, Tin, and other commodities.

SOYBEANS

The market opened £1 down on this trade, reports T. G. Roddick, Trade/Commercial selling pushed market down to close on the level of £2.63.

Table with columns: Commodity, Price, Change. Rows include Soybeans, Soybean Meal, and other commodities.

MEAT/FISH

SMITHFIELD—Prices per pound. Beef: 1.10-1.15, Pork: 1.10-1.15, Lamb: 1.10-1.15.

Table with columns: Commodity, Price, Change. Rows include Beef, Pork, Lamb, and other meat/fish products.

EUROPEAN MARKETS

ROTTERDAM, April 26. Wheat—(U.S. \$ per tonne): U.S. Two Soft Red Winter, May 198, June 10.

Table with columns: Commodity, Price, Change. Rows include Wheat, Corn, Soybeans, and other European market commodities.

WHEAT

Business done—Wheat: May 126.40, 25.00, July 126.20, 27.80, Sept 126.40, 28.00.

Table with columns: Commodity, Price, Change. Rows include Wheat, Barley, and other commodities.

GRAINS

Business done—Wheat: May 126.40, 25.00, July 126.20, 27.80, Sept 126.40, 28.00.

Table with columns: Commodity, Price, Change. Rows include Grains, Oilseeds, and other commodities.

SUGAR

LONDON DAILY PRICES—Raw sugar £13.00 (112.00), up £1.00 a tonne for April-May delivery.

Table with columns: Commodity, Price, Change. Rows include Sugar, and other commodities.

Handwritten signature: John Edwards

CURRENCIES; MONEY and CAPITAL MARKETS

FOREIGN EXCHANGES

Dollar continues to improve but narrowly fails to breach DM 2.70 level

The dollar continued to improve in currency markets yesterday and finished just below the day's high, having failed to breach the important DM 2.70 level against the D-mark.

Sterling opened on a slightly firmer note, almost matching the dollar's gains in terms of European currencies. It lost ground during the afternoon, however, after the opening of New York.

The D-mark weakened against several major currencies at the Frankfurt fixing, showing some nervousness on the part of the West German metal workers' union to ballot its members on regional strikes.

DM 1.6180 per 1,000 lira from DM 1.6190, and the Irish punt to DM 3.0640 from DM 3.0660.

FINANCIAL FUTURES

Eurodollars firm

Three-month Eurodollars for June delivery closed at the day's peak of 88.58 on the London International Financial Futures Exchange, helped by gains in early trading on the equivalent Chicago IMM contract.

It failed to hold on to the early gains however, following the success of the Government Broker in selling stock on the cash market. After opening at 107.17 June gilts touched a peak of 107.00, but then fell back to a low of 107.06 as the decline of the pound against the strong dollar depressed both the cash and futures markets.

THE DOLLAR SPOT AND FORWARD

Table with columns: Apr 28, Day's, Close, One month, % Three months, % Six months. Includes data for UK, Ireland, Canada, etc.

THE POUND SPOT AND FORWARD

Table with columns: Apr 28, Day's, Close, One month, % Three months, % Six months. Includes data for Canada, Ireland, Denmark, etc.

OTHER CURRENCIES

Table with columns: Apr 28, \$, £, Note Rates. Includes Argentina, Australia, Brazil, etc.

CURRENCY MOVEMENTS

Table with columns: Apr 28, Bank of England Index, Morgan Guaranty Index, Special Currencies, European Currency Unit. Includes Sterling, U.S. dollar, etc.

EXCHANGE CROSS RATES

Table with columns: Apr 28, Pound Sterling, U.S. Dollar, Deutsche mks, Japanese Yen, etc.

EURO-CURRENCY INTEREST RATES (Market closing rates)

Table with columns: Apr 28, Sterling, U.S. Dollar, Canadian Dollar, Dutch Guilder, etc.

MONEY MARKETS

London rates show little change

UK rates were little changed yesterday despite a weaker pound. Three-month eligible bank bills were bid at 8 1/2 per cent, unchanged from Wednesday.

The Bank forecast a shortage of £17m of eligible bank bills in band 1 (up to 14 days) at 8 1/2 per cent and £10m in band 2 (15-33 days) at 8 1/4 per cent.

of eligible bank bills at 8 1/2 per cent and in band 4 £2m of Treasury bills and £27m of eligible bank bills at 8 1/2 per cent.

Further assistance was given in the afternoon of £245m with purchases of £96m of eligible bank bills in band 1 at 8 1/2 per cent and in band 2 £24m of Treasury bills and £36m of eligible bank bills at 8 1/2 per cent.

MONEY RATES

Table with columns: Apr 28, Frankfurt, Paris, Zurich, Amsterdam, Tokyo, Milan, Brussels, Dublin. Includes Overnight, One month, etc.

LONDON MONEY RATES

Table with columns: Apr 28 1984, Sterling, Interbank, Local Authority deposits, etc.

Discount Houses Deposit and Bill Rates

Table with columns: Apr 28 1984, Sterling, Interbank, Local Authority deposits, etc.

FT LONDON INTERBANK

Table with columns: LONDON INTERBANK FCING, 111.00, 3 months U.S. dollars, etc.

MONEY RATES NEW YORK (Lunchtime)

Table with columns: Prime rate, Broker's call, Fed funds, Treasury Bills, etc.

FT LONDON INTERBANK

The fixing rates are the interbank means, rounded to two decimal places, of the bid and offered rates for \$10m quoted by the market to five reference banks at 11 a.m. on the working day. The banks are National Westminster Bank, Bank of Tokyo, Deutsche Bank, BNP Paribas, and Citicorp.

TREASURY BONDS

Table with columns: Two year, Three year, Five year, Seven year, Ten year, 30 year. Includes % and % yield.

MIKUN'S CREDIT RATINGS on about 1,800 bond issues by more than 500 Japanese companies. For details write: Mikuni & Co., Ltd. Dai-ichi Mori Building 1-chome Minato-ku, Tokyo 105, Japan or Telex J33118

Legal Notices. No. 001221 of 1984. IN THE HIGH COURT OF JUSTICE CHANCERY DIVISION. MR. JUSTICE MERVYN DAVIES. THE MATTER OF THE COMPANIES ACT 1948 AND IN THE MATTER OF THE COMPANIES ACT 1948. NOTICE IS HEREBY GIVEN that the order of the High Court of Justice, Chancery Division dated the 16th April 1984 CONFIRMING THE REDUCTION OF THE CAPITAL OF THE above-named Company from £250,000 to £100,000 and the Minutes approved by the Court showing with respect to the Share Capital of the Company as altered, the several particulars required by the above Act were registered by the Registrar of Companies on 16th April 1984.

Art Galleries. MARTYN GREGORY. The Overland Road, 105, The Mall, London, W.1. (1854-1894). Exhibiting Contemporary and International Art. LUMLEY CAZALEK, 22, Dukes St., W.1. (1854-1894). Exhibiting Contemporary and International Art.

Financial Times Surveys. The publication dates of two Financial Times surveys due to appear next week have been rearranged as follows: Lancashire will now be published on Monday 30th April. Gold will now be published on Wednesday 2nd May.

WORLD VALUE OF THE DOLLAR

Bank of America NT & SA, Economics Department, London

The Table below gives the rates of exchange for the U.S. dollar against various currencies as of April 25 1984. These rates are listed as indicated. All currencies are quoted in foreign currency units per one U.S. dollar except in certain specified areas. All rates quoted are indicative.

Table with columns: COUNTRY, CURRENCY, VALUE OF DOLLAR, VALUE OF CURRENCY, VALUE OF DOLLAR. Includes Afghanistan, Algeria, Andorra, Angola, etc.

n.a. Not available. (f) Market rate. (u) U.S. dollars per National Currency unit. (a) Free market. (c) Central bank. (o) Official rate. (d) Free market. (e) Floating rate. (f) Fixed rate. (g) Fixed rate. (h) Fixed rate. (i) Fixed rate. (j) Fixed rate. (k) Fixed rate. (l) Fixed rate. (m) Fixed rate. (n) Fixed rate. (o) Fixed rate. (p) Fixed rate. (q) Fixed rate. (r) Fixed rate. (s) Fixed rate. (t) Fixed rate. (u) Fixed rate. (v) Fixed rate. (w) Fixed rate. (x) Fixed rate. (y) Fixed rate. (z) Fixed rate.

COMPANY NOTICES

WESTERN DEEP LEVELS LIMITED

Notice is hereby given that in respect of the interest on the debentures for the period January 1 to June 30 1984, warrants bearing the latter date will be posted from the Johannesburg and United Kingdom offices of the transfer secretaries on or about June 20 1984 to debenture holders registered at the close of business on May 25 1984.

By order of the board ANGLO AMERICAN CORPORATION OF SOUTH AFRICA LIMITED Secretaries per R. S. Edmunds Divisional Secretary

ANGLO AMERICAN INDUSTRIAL CORPORATION LIMITED

RIGHTS OFFER TO RAISE R100 MILLION

The directors of Amic announce their intention to proceed with a rights offer of ordinary shares to ordinary shareholders and option holders to raise R100 million.

In recent years Amic has made a number of significant new investments and has embarked on major capital expansion programmes in its operating subsidiaries.

The Amic group is budgeting for an increase in earnings in 1984 and, in the absence of unforeseen circumstances, the directors intend at least to maintain the Amic dividend at 100 cents per share on the increased capital after the rights offer.

It is intended that the rights offer will be made to ordinary shareholders and option holders registered in the books of the corporation at the close of business on Friday, May 25 1984 ("the record date").

Further details of the rights offer and confirmation of the record date will be announced in due course.

JOHANNESBURG April 26 1984

THE RIO TINTO ZINC CORPORATION

ANNUAL GENERAL MEETING

NOTICE IS HEREBY GIVEN THAT the Annual General Meeting of the Rio Tinto Zinc Corporation will be held at the Royal Albert Hall, London, on Friday, May 11 1984 at 2.30 pm for the following purposes:

1. To receive and consider the accounts and reports of the directors and the auditors for the year ended 31st December 1983.

2. To consider and, if thought fit, to pass resolutions in connection with the proposed increase of the authorised share capital of the company to £110 million.

3. To consider and, if thought fit, to pass resolutions in connection with the proposed issue of shares of 50 million new shares of 50p each.

4. To consider and, if thought fit, to pass resolutions in connection with the proposed issue of shares of 50 million new shares of 50p each.

FT INTERNATIONAL BOND SERVICE

The list shows the 200 latest international bond issues for which an adequate secondary market exists. The following are closing prices for April 26.

Table with columns: U.S. DOLLAR, Issue, Amount, Bid, Offer, Change, Week, Yield. Includes entries like American Savings 11 3/4, American Savings 12 3/4, American Savings 13 3/4.

Table with columns: EUROPEAN, Issue, Amount, Bid, Offer, Change, Week, Yield. Includes entries like Anglo-Saxon 11 1/2, Anglo-Saxon 12 1/2, Anglo-Saxon 13 1/2.

Table with columns: SWISS FRANC, Issue, Amount, Bid, Offer, Change, Week, Yield. Includes entries like Swiss Franc 11 1/2, Swiss Franc 12 1/2, Swiss Franc 13 1/2.

Table with columns: YEN STRAIGHTS, Issue, Amount, Bid, Offer, Change, Week, Yield. Includes entries like Japan Dev 7 1/2, Japan Dev 8 1/2, Japan Dev 9 1/2.

Table with columns: S-S, Issue, Amount, Bid, Offer, Change, Week, Yield. Includes entries like S-S 11 1/2, S-S 12 1/2, S-S 13 1/2.

Table with columns: Stock, Sales, High, Low, Last, Change. Includes entries like Anglo-Saxon, Anglo-Saxon, Anglo-Saxon.

Table with columns: Stock, Sales, High, Low, Last, Change. Includes entries like Anglo-Saxon, Anglo-Saxon, Anglo-Saxon.

Table with columns: Stock, Sales, High, Low, Last, Change. Includes entries like Anglo-Saxon, Anglo-Saxon, Anglo-Saxon.

New Brunswick in first EuroCanadian floating rate note

SALOMON BROTHERS monopolized the EuroCanadian bond market yesterday by leading the only two new deals of the day, as well as an \$800m Yankee bond for Sweden in the U.S.

It broke new ground in the EuroCanadian dollar market by launching the first Canadian dollar floating rate note. The province of New Brunswick is raising C\$75m through a 10-year FRN which has a put option for investors after 5 1/2 years.

The coupon is 1/4 per cent over a three-month composite Canadian dollar deposit rate which is based on the BHF Bank bond average.

on a combination of the U.S. interbank forward rate and the spot and forward rates for the U.S. dollar against the Canadian dollar. Front-end fees are 0.60 per cent.

The bond is exempt from the restrictions placed on the sale of many EuroCanadian issues in Canada because it is issued by a province. Demand is therefore expected to come from Canada and Europe, and possibly Japan.

The issue was launched too late in the day for a price level to be reached. Caisse Centrale de Cooperation Economique, France's foreign aid agency, yesterday issued a series of zero-coupon bonds through Salomon Brothers and Banque Paribas.

In total, it is raising \$100m and the series consists of 25 tranches worth \$3.8m each and one tranche of \$100m.

The small tranches mature annually from May 1, 1985 to 2000, which is also the year in which the \$100m tranche is redeemed. The bonds are sold at a discount and the yields vary from 11.53 per cent for the first tranche to a peak of 13.67 per cent on the tranche maturing in 1992.

The \$100m tranche yields 11.67 per cent. C. Itoh, the Japanese trading company, is raising \$50m through a five-year bond with warrants guaranteed by Dai-ichi Kangyo Bank.

The indicated coupon is 7 1/2 per cent and the deal has the standard warrant structure. Nikko Securities, Robert Fleming and Dai-ichi Kangyo Bank are leading the issue, which is traded at a steep 3/4 per cent discount.

Today should see the launch of a yen-linked bond for Chubu Electric Power, a consequence of the recent liberalisation measures by the Japanese Ministry of Finance. The bond has a five-year life and will probably pay a 6 per cent coupon at a price of 98 1/2. The amount will be the dollar equivalent of ¥10bn.

Nomura Securities is leading the deal. Prices of seasoned bonds rose by 1/4 point in the dollar sector but closed unchanged in D-Marks and Swiss francs.

Table with columns: April 26, Previous, High, Low, 100,000. Includes entries like 98.55, 98.55, 100.00, 100.00.

Table with columns: April 26, April 18, High, Low. Includes entries like 13.32, 13.22, 13.32, 13.19.

Table with columns: Composite Corp. AA, Government, Long-term, Intermediate, Short-term, Municipal, Industrial AAA, Industrial AA, Industrial A, Utilities AA, Preferred Stocks.

Source: Standard & Poor's

STANWICK INTERNATIONAL CORPORATION S.A. Commercial Register Section B No 131412. NOTICE IS HEREBY GIVEN that the Board of Directors of Stanwick International Corporation S.A. has decided to increase the share capital of the company.

CONTRACTS & TENDERS. Bids should be addressed in closed envelopes to: The Director of the Office for the Mena Development Project, P.O. Box 6172, Jeddah, Kingdom of Saudi Arabia.

ANNOUNCEMENT. Sale of skins of Sacrificial Sheep "ALHADI" and "AL-ADAHI" at the Al Moasim model abattoir in Mena for the benefit of poor Muslims.

CONTRACTS & TENDERS. Bids should be addressed in closed envelopes to: The Director of the Office for the Mena Development Project, P.O. Box 6172, Jeddah, Kingdom of Saudi Arabia.

ANNOUNCEMENT. The Sacrificial Meat Utilization Committee announces the sale of approximately 200,000 sheepskins skinned by expert butchers at the Moasim model abattoir set aside at the disposal of the Sacrificial Meat Utilization Committee (for the year 1404H Haj season).

CONTRACTS & TENDERS. Bids should be submitted not later than the end of working hours on Wednesday, 16th May, 1984, specifying the quantity the bidder can undertake to purchase at the price listed in the bid.

COMMITTEE SUPERVISING THE SACRIFICIAL MEAT UTILIZATION PROJECT. A bank guarantee representing 1 per cent of the value of the bid shall be attached.

OVER-THE-COUNTER

Table with columns: Stock, Sales, High, Low, Last, Change. Includes entries like Anglo-Saxon, Anglo-Saxon, Anglo-Saxon.

IF IT'S ON CONQUEROR, IT MUST BE IMPORTANT. THE BUSINESS STATIONERY. Wiggins Teape Fine Paper Mills. The CONQUEROR AND HORSEMAN symbols is a trade mark of Wiggins Teape (UK) PLC.

PHILIPS WARRANTS 1983. Notice is hereby given to the Warrant holders that as decided upon by the general meeting of shareholders of Philips Gloeilampenfabrieken, the rate of one new share for each ten shares held.

WARRANTS 1983. Notice is hereby given to the Warrant holders that as decided upon by the general meeting of shareholders of Philips Gloeilampenfabrieken, the rate of one new share for each ten shares held.

PHILIPS WARRANTS 1983. Notice is hereby given to the Warrant holders that as decided upon by the general meeting of shareholders of Philips Gloeilampenfabrieken, the rate of one new share for each ten shares held.

Credit du Nord. The Board of Directors of CREDIT DU NORD met on April 17 and approved the 1983 annual accounts which show a net profit of FF 152.6 million. This figure includes extraordinary capital gains of FF 188.1 million and net losses of FF 22.2 million in 1982.